



READERS AND CREDENTIALS HOW TO ORDER GUIDE

PLT-02630, A.3

February 2017

Note: This document is subject to change without notice. The current version of this document is available for download at: <https://www.hidglobal.com/document-library>.

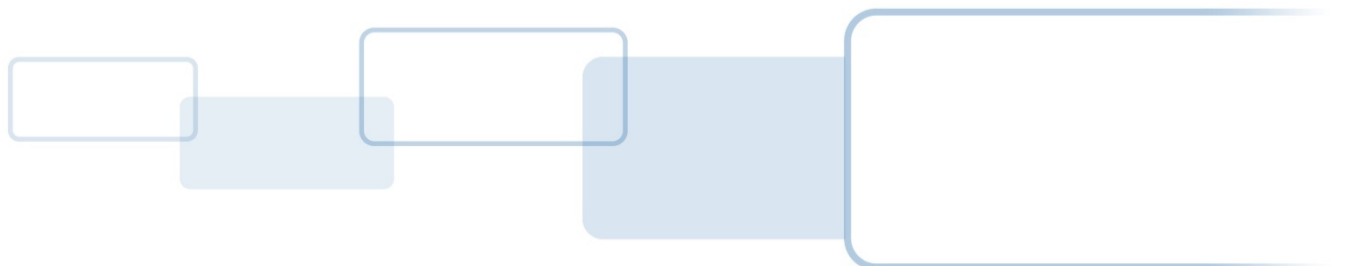

Copyright

©2016 - 2017 HID Global Corporation/ASSA ABLOY AB.

All rights reserved. This document may not be reproduced, disseminated or republished in any form without the prior written permission of HID Global Corporation.

Trademarks

HID Global, HID, the HID logo, Corporate 1000, DuoProx, EntryProx, FlexCard, FlexISO, FlexPass, FlexSmart, Genuine HID, HID Elite, HID Mobile Access, iCLASS, iCLASS Elite, iCLASS SE, Indala, ISOProx, EDGE, EDGE EVO, MaxiProx, MicroProx, MiniProx, multiCLASS, multiCLASS SE, pivCLASS, ProxCard, ProxCard II, ProxKey, ProxPass, ProxPoint, ProxPro, Secure Identity Object, Seos, ThinLine II, and University 1000 are the trademarks or registered trademarks of HID Global Corporation, or its licensors, in the U.S. and other countries.

MIFARE, MIFARE DESFire, MIFARE Classic, and MIFARE DESFire EV1 are registered trademarks of NXP B.V. and are used under license.

Revision History

Date	Description	Version
February 2017	Removed EOL products, image updates	A.3
December 2016	Seos 8k options note, added new 522 iCLASS Seos + iCLASS Card. Amended 520 iCLASS + Seos + iCLASS + Prox.	A.2
September 2016	iCLASS SE U90, wiring connection updates.	A.1
March 2016	Initial release	A.0

Contacts

For additional offices around the world, see www.hidglobal.com corporate offices.

North America	Asia Pacific
611 Center Ridge Drive Austin, TX 78753 USA Phone: 866-607-7339 Fax: 949-732-2120	19/F 625 King's Road North Point, Island East Hong Kong Phone: 852 3160 9833 Fax: 852 3160 4809
Europe, Middle East and Africa	Brazil
Haverhill Business Park Phoenix Road Haverhill, Suffolk CB9 7AE England Phone: 44 (0) 1440 711 822 Fax: 44 (0) 1440 714 840	Condomínio Business Center Av. Ermanno Marchetti, 1435 Galpão A2 CEP 05038-001 Lapa - São Paulo/SP Brazil Phone: 55 11 5514-7100

HID Global Customer Support: www.hidglobal.com/support



CONTENTS

- Readers 5**
 - Understanding HID Global Readers 5
 - What should I know about security keysets? 5
 - How can I order HID Elite configured readers? 5
 - How can I check the status of my order? 5
 - Selecting the Right Reader 6
 - iCLASS SE Readers 7
 - iCLASS SE Reader - Seos Profile with Bluetooth Option 7
 - iCLASS SE Reader - Standard Profile with Bluetooth 9
 - iCLASS SE Reader - Standard Profile 11
 - iCLASS SE Reader - Magnetic Stripe 13
 - pivCLASS Reader - FIPS 201 Strong Authentication 15
 - pivCLASS Reader - Wiegand or OSDP 17
 - iCLASS SE U90 - UHF Long Range Reader 18
 - iCLASS SE Reader Accessories 19
 - iCLASS Readers 22
 - bioCLASS Biometric Reader/Enroller - 6180 / 6188 22
 - iCLASS LCD Reader - 6170 / 6178 23
 - iCLASS Read/Write Reader - 6141 / 6111 / 6121 / 6131 / 6171 24
 - EDGE® Reader - EDGE EVO Solo 25
 - iCLASS Reader Accessories 26
 - HID Proximity Readers 27
 - ProxPoint Plus Proximity Reader - 6005 / 6008 27
 - MiniProx Proximity Reader - 5365 / 5368 28
 - ProxPro Family Proximity Reader - 5455 / 5458 / 5355 / 5352 / 5358 29
 - ThinLine II Proximity Reader - 5395 / 5398 30
 - MaxiProx Proximity Reader - 5375 31
 - EntryProx Proximity Reader - 4045 32
 - HID Proximity Reader Accessories 33
 - Indala Proximity Readers 35
 - Overview 35
 - Advantage Series Reader - ASR 620 35
 - FlexPass™ Reader - FP Arch / Keypad 36
 - FlexPass Accessories 37
- HID Mobile Access 38**
 - What Is HID Mobile Access? 38
 - Onboarding and Ordering 38
 - Solution Component Overview 39
- Credentials 40**
 - Understanding HID Credentials 40
 - What should I know about security keysets? 40
 - How can I order HID Elite configured credentials? 40
 - How can I migrate from my current credential technology? 40
 - What is the difference between iCLASS Seos, iCLASS SE and iCLASS credentials? 41
 - Credentials Marking 42
 - Announcement Regarding Credentials Marking 43
 - iCLASS Seos Credentials [Recommended Technology] 44
 - iCLASS Seos Card - 500 44
 - iCLASS Seos + iCLASS Card - 522 45

iCLASS Seos + Prox Card - 510	47
iCLASS Seos + iCLASS + Prox Card - 520	48
iCLASS SE Credentials	50
iCLASS SE Card - 300 / 305.....	50
iCLASS SE + Prox Card - 310 / 315	51
iCLASS SE Key - 325	53
iCLASS SE Tag - 330	54
iCLASS SE Clamshell Card - 335	55
iCLASS SE + Other HF Card - 390 / 391	56
iCLASS SE + Other 13.56MHz + Prox Card - 395 / 396	58
iCLASS Credentials	60
iCLASS Card - 200 / 210.....	60
iCLASS + Prox card - 202 / 212	61
iCLASS Key - 205	63
iCLASS Tag - 206	64
iCLASS Clamshell Card - 208.....	65
iCLASS + Other HF Card - 242.....	66
iCLASS + Other 13.56 MHz + Prox Card - 262.....	68
UHF Credentials	70
UHF Card - 600.....	70
UHF + iCLASS Card - 601	71
UHF + MIFARE Classic Card - 603.....	73
HID Proximity Credentials.....	75
ProxCard II Card - 1326	75
DuoProx® II Card - 1336 / 1536.....	76
ProxKey III Keyfob - 1346	77
ISOProx® II Card - 1386 / 1586	78
ProxPass® II Vehicle Identification Tag - 1351	79
MicroProx® Tag Proximity - 1391	80
ProxCard Plus Card - 168 / 169	81
Indala 125kHz Credential	83
FPISO - FlexPass Imageable Card	84
FPCRD - FlexCard Standard Card.....	85
FPTAG - FlexTag.....	86
FPKEY - FlexKey Keytag	87
MIFARE Credentials.....	89
MIFARE Classic Card - 340 / 345 / 1430 / 1440 / 1436 / 1446	89
MIFARE Classic + Prox card - 350 / 355 / 1431 / 1441 / 1437 / 1447	91
MIFARE Classic Keyfob - 1434 / 1444.....	93
MIFARE Classic Adhesive Tag - 1435.....	94
MIFARE DESFire EV1 Card - 370 / 375 / 1450 / 1456.....	95
MIFARE DESFire EV1 + Prox Card - 380 / 385 / 1451 / 1457	96
MIFARE Classic + MIFARE DESFire EV1 Card - 282	98
Credential Programmers	100
Understanding HID Credential programmers.....	100
Credential Encoder Ordering Basics	100
iCLASS SE Encoder Summary	101
iCLASS SE Encoder - How Does it Work?.....	101
iCLASS SE Encoder Order Form.....	103
iCLASS SE Encoder - Credential Credits.....	104

READERS

Understanding HID Global Readers

What should I know about security keysets?

iCLASS SE® readers and iCLASS Seos®/iCLASS SE credentials offer two keyset security schemes, HID Elite™ and Standard.

The **HID Elite Security Program** supports a unique keyset on a per site/company basis.

The keyset governs a variety of keys, including:

- Media (credential) keys for iCLASS SE, SIO-encoded iCLASS, MIFARE Classic® (SIO®) and MIFARE DESFire EV1® (SIO) credentials
- SIO authenticity and privacy keys (media independent)
- Configuration programming keys (for programming reader configuration, also media independent)

When utilizing HID's standard key set for the above keys, all standard keyed credentials work with all standard keyed readers. Additionally, any Standard Security configuration card configures a Standard Security reader (only accomplished during the first five (5) seconds after reader powers-up). Conversely, when utilizing the HID Elite program, only site/company specific HID Elite credentials and programming cards work with matching readers.

The **Standard Security Program** provides universal keysets that offer maximized compatibility by keying readers and cards with matching security for use in the general population. This allows for maximized compatibility because readers and cards are not keyed on a per site/company basis but rather all keyed the same. This offers the advantage to the integrator as a standard stock of readers and cards will interoperate for a variety of sites/companies, rather than needing different stocks of readers and cards for each individual site. iCLASS SE readers provide two Standard Security Keysets that offer compatibility with the following credentials:

Standard Security Keyset	Compatibility with these Credentials
Version 1	iCLASS Seos (+ Prox) iCLASS SE (+ Prox) iCLASS SR (+ Prox) iCLASS® (+ Prox) MIFARE Classic (+ Prox) MIFARE DESFire EV1 (+ Prox)
Version 2	iCLASS Seos (+ Prox) iCLASS SE (+ Prox) MIFARE Classic (+ Prox) MIFARE DESFire EV1 (+ Prox)

How can I order HID Elite configured readers?

- Direct customers of HID must be authorized to purchase components with HID Elite keys. If you are not authorized, you must have the key owner authorize you through the Authorization form. See <http://www.hidglobal.com/services/secure-identity/credential-programs/iclass-elite-and-se-elite>.
- Ensure the HID Elite flag is set in the part number (of readers, credentials and programming cards).
- All Purchase Orders for HID Elite components must be ordered with the HID Elite reference number (starts with ICE or MOB).

How can I check the status of my order?

- To check order status, go to: <https://orderstatus.hidglobal.com/WebOrderStatus/>

Selecting the Right Reader

In order to make sure our customers benefit from the latest and most secure technology, based on their needs and current situation, HID Global offers a reader product guidance. Follow the suggested route below based on your current credential population, to see what reader solution is recommended by HID Global.

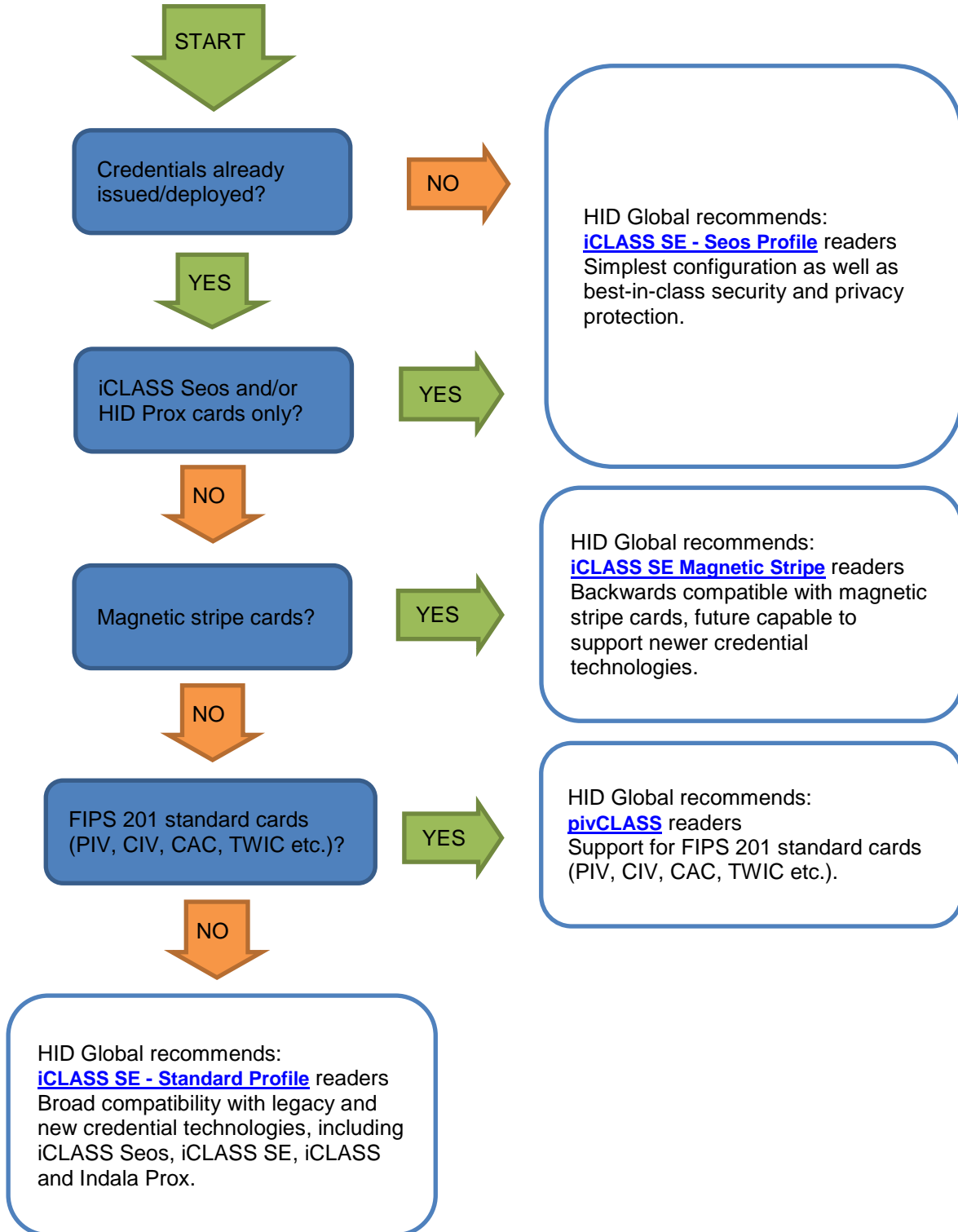

iCLASS SE Readers

Note: See *Selecting the Right Reader* on page 6 for guidance.

iCLASS SE Reader - Seos Profile with Bluetooth Option

Application: Designed to instill confidence with best-in-class security and privacy protection.

Technologies Supported: iCLASS Seos, HID Prox, and HID Mobile Access® Mobile IDs via NFC and/or Bluetooth Smart.



1. Select one option from each of the following sections to construct part number:

Reader Model (Select one model)



- 900 - Model R10 - Designed for door applications requiring a small footprint card reader.



- 910 - Model R15 - Designed for door applications requiring a mullion style mounting.



- 920 - Model R40 - Designed for door applications requiring standard wall switch mounting.



- 921 - Model RK40 - Designed for door applications requiring standard wall switch mounting and keypad input.

125 KHz Credential Support (Select one option)

- N - No 125 KHz support
 P - Support for HID Prox

13.56 MHz and Bluetooth credential support (Select one option)

- S - Supports iCLASS Seos cards, and Mobile IDs via NFC
 B - Supports iCLASS Seos cards, and Mobile IDs via NFC and Bluetooth Smart.

Controller Communication

- N - Wiegand

Wiring Connection (Select one option)

- N - Pigtail
 T - Terminal strip

Hardware Revision

- E - Revision E

Color

- K - Black

Keypad (Select one option)

- 2 - Standard and Mobile-Ready - supports iCLASS Seos credentials with standard keys. Prepared to support HID Mobile Access, but lacks the personalized configuration to read an organization's specific Mobile IDs. This configuration can be ordered at any time but will require field activation after the organization has completed registration for HID Mobile Access.
- E - HID Elite and Mobile-Enabled - supports iCLASS Seos credentials and Mobile IDs. Fully activated and personalized to support an organization's specific Mobile IDs. These readers can only be ordered after the organization has completed registration for either HID Elite or HID Mobile Access. If HID Elite reference (ICE) is given at time of order, only iCLASS Seos credentials with HID Elite keys are supported. If Mobile Reference (MOB) is given at time of order, only iCLASS Seos credentials with standard keys are supported.

Configuration Settings

- 0000 - Standard configuration. All iCLASS SE Readers - Seos Profile ship with the following standard configuration:
- LED normally red, LED flashes green and beeps on card read
 - Keypad output is 4-bit (if keypad reader)

Non-standard configuration can be applied at time of installation using the configuration card accessories listed on next page.

2. Enter the numbers/letters from the selections above into the table below.

The resulting "Final Part Number" is used when ordering reader.

	Reader Model	125 KHz	13.56 MHz	Communication	Wiring	HW Rev	Color	Keypad	Config Setting
Example	920	N	S	N	T	E	K	2	0000
Final Part Number				N		E	K		0000

3. Place an order.

To place an order for this product, authorized channel partners may submit a purchase order to HID Global Customer Service.

Contact information is available at: <http://www.hidglobal.com/customer-service>

Need credentials? Credentials supported by this reader model includes (depending on options chosen above):

- [Mobile IDs](#)
- [iCLASS Seos](#)
- [iCLASS Seos + Prox](#)

iCLASS SE Reader - Seos Profile Configuration Cards

Config Card Number	Description
SE-SEOS-2-CRD0	iCLASS SE Seos Profile readers configuration config cards - Standard keys (2) - all cards (21 cards)
SE-SEOS-E-CRD0	iCLASS SE Seos Profile readers configuration config cards - HID Elite keys - all cards (21 cards)
SE-SEOS-2-CRD1	iCLASS SE Seos Profile readers configuration config cards - Standard keys (2) - Seos and prox settings (4 cards) Contains cards used to change the priority setting of iCLASS Seos and Prox technologies
SE-SEOS-2-CRD2	iCLASS SE Seos Profile readers configuration config cards - Standard keys (2) - Panel output settings (3 cards) Contains cards used to change the reader output between Wiegand and OSDP
SE-SEOS-2-CRD3	iCLASS SE Seos Profile readers configuration config cards - Standard keys (2) - Audio visual settings (13 cards) Contains cards used to change behaviour of reader LED and beeper
SE-SEOS-2-CRD4	iCLASS SE Seos Profile readers configuration config cards - Standard keys (2) - keypad format settings (4 cards) Contains cards used to change output settings of keypad reader models
SE-SEOS-E-CRD1	iCLASS SE Seos Profile readers configuration config cards - HID Elite keys - Seos and prox settings (4 cards) Contains cards used to change the priority setting of iCLASS Seos and Prox technologies
SE-SEOS-E-CRD2	iCLASS SE Seos Profile readers configuration config cards - HID Elite keys - Panel output settings (3 cards) Contains cards used to change the reader output between Wiegand and OSDP
SE-SEOS-E-CRD3	iCLASS SE Seos Profile readers configuration config cards - HID Elite keys - Audio visual settings (13 cards) Contains cards used to change behaviour of reader LED and beeper
SE-SEOS-E-CRD4	iCLASS SE Seos Profile readers configuration config cards - HID Elite keys - keypad format settings (4 cards) Contains cards used to change output settings of keypad reader models

Note: The above configuration cards are only intended for use with iCLASS SE Reader - Seos profile.

iCLASS SE Reader - Standard Profile with Bluetooth

Application: Designed to ensure compatibility with legacy credentials and capability to support the future.

Technologies Supported: Wide variety of contactless credentials including HID Mobile Access Mobile IDs via NFC and/or Bluetooth Smart.



1. Select one option from each of the following sections:

Reader Model (Select one model)



900 - Model R10 - Designed for door applications requiring a small footprint card reader.



910 - Model R15 - Designed for door applications requiring a mullion style mounting.



920 - Model R40 - Designed for door applications requiring standard wall switch mounting.



921 - Model RK40 - Designed for door applications requiring standard wall switch mounting and keypad input.

125 KHz Credential Support (Select one option)

- N - No 125 KHz support
 P - Support for HID Prox, AWID and EM4102 (32 bits)

13.56 MHz and Bluetooth Credential Support

- M - Support for HID Mobile Access Mobiles IDs via NFC and Bluetooth Smart - reader equipped with Bluetooth Smart module. Also supports iCLASS Seos, iCLASS SE, iCLASS SR, iCLASS, MIFARE Classic (SIO), MIFARE DESFire EV1 (SIO) and ISO 14443 UID.

Controller Communication (Select one option)

- N - Wiegand
 C - Clock & Data
 P - OSDP

Wiring Connection (Select one option)

- N - Pigtail
 T - Terminal strip

Hardware Revision

- E - Revision E

Color

- K - Black

Keypad (Select one option)

- M - Mobile-Ready: Prepared to support HID Mobile Access, but lacks the personalized configuration to read an organization's specific Mobile IDs. This configuration can be ordered at any time but will require field activation after the organization has completed registration for HID Mobile Access.
- E - Mobile-Enabled: Fully activated and personalized to support an organization's specific Mobile IDs. These readers can only be ordered after the organization has completed registration for either HID Elite or HID Mobile Access. If HID Elite reference (ICE) is given at time of order, only iCLASS Seos credentials with HID Elite keys are supported. If Mobile Reference (MOB) is given at time of order, only iCLASS Seos credentials with standard keys are supported.

Configuration Setting (Select one option)

Standard configuration: All iCLASS SE Readers - Standard Profile with Bluetooth Smart ship with the following features

- Controller Communication = N - Wiegand, or P - OSDP
- LED normally red, LED flashes green and beeps on card read
- Keypad output is 4-bit (if keypad reader)

This configuration is represented by the following standard configuration setting extensions listed.

Communication	125KHz Support	Keypad Reader	Extension
N - Wiegand	N - No	No	<input type="checkbox"/> A001
		Yes	<input type="checkbox"/> A002
	P - Yes	No	<input type="checkbox"/> A003
		Yes	<input type="checkbox"/> A004
P - OSDP	N - No	No	<input type="checkbox"/> A005
		Yes	<input type="checkbox"/> A006
	P - Yes	No	<input type="checkbox"/> A007
		Yes	<input type="checkbox"/> A008

ANY other option selected (including Clock & Data communication) requires a Non-Standard configuration EXTENSION. To determine configuration options, use the Select tab on the iCLASS SE Configuration Guide spreadsheet at the following link: www.hidglobal.com/node/19914. Your HID Global Support or Sales representative can help you determine your final configuration.

2. Enter the numbers/letters from the previous selections into the following table.

The resulting "Final Part Number" is used when ordering reader.

	Reader Model	125 KHz	13.56 MHz	Communication	Wiring	HW Rev	Color	Keypad	Config Setting
Example	920	N	M	N	T	E	K	M	A001
Final Part Number			M			E	K		

3. Place an order.

To place an order for this product, authorized channel partners may submit a purchase order to HID Global Customer Service.

Contact information is available at: <http://www.hidglobal.com/customer-service>

Need credentials? Credentials supported by this reader model includes (depending on options chosen above):

- [Mobile IDs](#)
- [iCLASS Seos](#)
- [iCLASS](#)
- [MIFARE DESFire EV1](#)
- [MIFARE Classic](#)



iCLASS SE Reader - Standard Profile

Application: Designed to ensure compatibility with legacy credentials and capability to support the future.

Technologies Supported: Wide variety of contactless credentials including HID Mobile Access Mobile IDs via NFC.



1. Select one option from each of the following sections:

Reader Model (Select one model)

- | | |
|---|---|
|  <input type="checkbox"/> 900 - Model R10 - Designed for door applications requiring a small footprint card reader. |  <input type="checkbox"/> 921 - Model RK40 - Designed for door applications requiring standard wall switch mounting. Supports keypad input. |
|  <input type="checkbox"/> 910 - Model R15 - Designed for door applications requiring a mullion style mounting. |  <input type="checkbox"/> 940 - Model R90 - Designed for vehicle access applications requiring extended read range. |
|  <input type="checkbox"/> 920 - Model R40 - Designed for door applications requiring standard wall switch mounting. |  <input type="checkbox"/> 95A - Décor model - Designed for door applications requiring low profile EU square wall switch mounting. |

125 KHz Credential Support (Select one option)

- N - None
- P - Supports HID Prox, AWID and EM4102 (32 bits). *Not available on models 940 or 95A.*
- L - Supports Indala® Prox, please make sure to provide needed format at time of order. *Not available on models 940 or 95A. Not available with OSDP communication and/or Custom Programming or Transit.*

13.56 MHz Credential Support (Select one option)

- N - High security
- T - Maximum compatibility
- R - FeliCa and CEPAS¹
- W - Custom programming²

	iCLASS Seos	iCLASS SE	iCLASS SR	iCLASS	MIFARE Classic (SIO)	MIFARE DESFire EV1 (SIO)	Mobile IDs via NFC	Mobile IDs via Bluetooth Smart	ISO14443 UID	MIFARE Classic (Custom data)	MIFARE DESFire EV1 (Custom data)	FeliCa Idm	CEPAS CAN or UID
<input type="checkbox"/> N - High security	•	•	•	-	•	•	•	-	-	-	-	-	-
<input type="checkbox"/> T - Maximum compatibility	•	•	•	•	•	•	•	-	•	-	-	-	-
<input type="checkbox"/> R - FeliCa and CEPAS ¹	•	•	•	•	•	•	•	-	•	-	-	•	•
<input type="checkbox"/> W - Custom programming ²	○	○	○	○	○	○	○	-	○	•	•	-	-

• Supported
○ Optionally supported
- Not supported

¹ Not available on model 940.

² Consult your regional technical support representative for specific configurations.

Controller Communication (Select one option)

- N - Wiegand
- C - Clock & Data
- P - OSDP

Wiring Connection (Select one option)

- N - Pigtail (Not available on models 940 or 95A)
- T - Terminal strip

Hardware Revision

- E - Revision E



Color (Select one option)

- K - Black
- W - White. Only available on 95A model.
- G - Gray. Only available on 95A model.

Keypad (Select one option)

- 0 - Standard v1 - Supports credentials with default HID keys, including iCLASS and iCLASS SR.
- 2 - Standard v2 - Supports credentials with default HID keys, not including iCLASS and iCLASS SR.
- E - HID Elite - Supports credentials with HID Elite keys, including iCLASS and iCLASS SR, and/or Mobile IDs. Key reference (ICE or MOB) required at time of order.

Configuration Setting

- 0000 - Standard configuration:
 - 13.56MHz Credential Support = T - Maximum Compatibility
 - Controller Communication = N - Wiegand
 - Keypad = 0 - Standard v1 or E - HID Elite
 - LED normally red, LED flashes green and beeps on card read
 - Keypad output is 4-bit (if keypad reader)
- xxxx - Non-Standard configuration: ANY other options selected above requires a Non-Standard 4 digit extension. To order non-standard configuration options, use the Select tab on the iCLASS SE Configuration spreadsheet at the following link www.hidglobal.com/node/19914. Your HID Global Support or Sales representative can help you determine your final configuration.

2. Enter the numbers/letters from the selections above into the following table:

The resulting "Final Part Number" is used when ordering reader.

Reader Model		125 KHz	13.56 MHz	Communication	Wiring	HW Rev	Color	Keypad	Config Setting
Example	920	N	T	N	T	E	K	2	0000
Final Part Number						E			

3. Place an order.

To place an order for this product, authorized channel partners may submit a purchase order to HID Global Customer Service. Contact information is available at: www.hidglobal.com/customer-service

Need credentials? Credentials supported by this reader model include the following, depending on options chosen above:

- [Mobile IDs](#)
- [iCLASS Seos](#)
- [iCLASS](#)
- [iCLASS SE](#)
- [MIFARE DESFire EV1](#)
- [MIFARE Classic](#)



iCLASS SE Reader - Magnetic Stripe

Application: Designed to ensure compatibility with legacy credentials and capability to support the future.

Technologies Supported: Magnetic stripe cards and a wide variety of contactless credentials including HID Mobile Access Mobile IDs via NFC.



1. Select one option from each of the following sections:

Reader Model (Select one model)



922 - Model RM40 - Designed for door applications requiring standard wall switch mounting.



925 - Model RMK40 - Designed for door applications requiring standard wall switch mounting. Supports keypad input.

125 KHz Credential Support (Select one option)

- N - No 125 KHz support
- P - Support for HID Prox, AWID and EM4102 (32 bit)

13.56 MHz Credential Support (Select one option)

- T - Maximum compatibility
- N - High security Weigand
- W - Custom programming*

	iCLASS Seos	iCLASS SE	iCLASS SR	iCLASS	MIFARE Classic (SIO)	MIFARE DESFire EV1 (SIO)	Mobile IDs via NFC	Mobile IDs via Bluetooth Smart	ISO14443 UID	MIFARE Classic (Custom data)	MIFARE DESFire EV1 (Custom data)
<input type="checkbox"/> T	●	●	●	●	●	●	●	-	●	-	-
<input type="checkbox"/> N	●	●	●	-	●	●	●	-	-	-	-
<input type="checkbox"/> W	○	○	○	○	○	○	○	-	○	●	●

● Supported
○ Optionally supported
- Not supported

* Consult your regional technical support representative for specific configurations.

Controller Communication (Select one option)

- N - Wiegand
- C - Clock & Data
- P - OSDP

Wiring Connection (Select one option)

- N - Pigtail
- T - Terminal strip

Hardware Revision

- E - Revision E

Color

- K - Black

iCLASS Support/Keypad (Select one option)

- 0 - Standard v1 - Reads credentials with default HID keys including standard iCLASS and/or iCLASS SR.
- 2 - Standard v2 - Reads credentials with default HID keys not including standard iCLASS and/or iCLASS SR.
- E - HID Elite - Reads credentials with HID Elite keys, including iCLASS and iCLASS SR, and/or Mobile IDs. *Key reference (ICE or MOB) required at time of order.*

Configuration Settings

To determine configuration options, use the **Select** tab on the *iCLASS SE Configuration Guide* spreadsheet at the following link: www.hidglobal.com/node/19914. Your HID Global Support or Sales representative can help you determine your final configuration.

2. Enter the numbers/letters from the selections above into the table below.

The resulting "Final Part Number" is used when ordering reader.

Reader Model		125 KHz	13.56 MHz	Communication	Wiring	HW Rev	Color	Keypad	Config Setting
Example	922	N	N	N	T	E	K	2	0000
Final Part Number						E	K		

3. Place an order.

To place an order for this product, authorized channel partners may submit a purchase order to HID Global Customer Service.

Contact information is available at: www.hidglobal.com/customer-service.

Need credentials? Credentials supported by this reader model include (depending on options chosen above):

- [Mobile IDs](#)
- [iCLASS Seos](#)
- [iCLASS SE](#)
- [iCLASS](#)
- [HID Prox](#)
- [MIFARE DESFire EV1](#)
- [MIFARE Classic](#)



pivCLASS Reader - FIPS 201 Strong Authentication

Application: Designed for applications that leverage the pivCLASS® Authentication Module (PAM) to validate FIPS 201 credential certificates for the highest level of security.

Technologies Supported: FIPS 201 credentials such as PIV, CIV, TWIC, CAC, and FRAC, and a wide variety of other contactless credentials.



1. Select one option from each section below:

Reader Model (Select one model)



- 900 - Model R10 - Designed for door applications requiring a small footprint card reader.



- 923 - Model RKCL40 - Designed for door applications requiring standard wall switch mounting. Featuring a contact slot, LCD display, and keypad.



- 920 - Model R40 - Designed for door applications requiring standard wall switch mounting.



- 924 - Model RKCLB40 - Designed for door applications requiring standard wall switch mounting. Featuring a contact slot, LCD display, biometric sensor, and keypad.



- 921 - Model RK40 - Designed for door applications requiring standard wall switch mounting. Supports keypad input.

125 KHz Credential Support (Select one option)

- N - No 125 KHz support
 P - Support for HID Prox, AWID and EM4102 (32 bit) (not available on model RKCLB40)

13.56 MHz credential support (Select one option)

- H - Contactless. Supports PKI-Based FIPS 201 Credentials including PIV, PIV-I, CIV, CAC, TWIC and FRAC. This option is only available for models R10, R40 and RK40.
 P - Contactless + Contact. Supports PKI-Based FIPS 201 Credentials including PIV, PIV-I, CIV, CAC, TWIC and FRAC. FIPS 201 type cards can be read using either the contact or contactless card interface (RKCL40). This option is only available for models RKCL40, and RKCLB40.

Controller Communication (Select one option)

- R - RS485 FDx. Full duplex is required when connecting a pivCLASS reader to a PAM.
 P - RS485 HDX OSDP. Half duplex connection requires a connection with an OSDP-compliant strong authentication controller infrastructure. Only available with RKCL40.

Controller Connection (Select one option)

- N - Pigtail
 T - Terminal strip

Hardware Revision

- E - Revision E

Color

- K - Black

Keypad (Select one option)

- 0 - Standard v1 - Reads credentials with default HID keys including standard iCLASS and/or iCLASS SR.
 E - HID Elite - Reads credentials with HID Elite keys, including iCLASS and iCLASS SR, and/or Mobile IDs. *Key reference (ICE or MOB) required at time of order.*

Configuration Setting (Select one option)

Configuration setting extension for these reader models depends on the model and 125KHz support chosen above, select from list below:

Reader Model	125KHz Support	Extension
R10/R40	N - No	<input type="checkbox"/> 032Y
	P - Yes	<input type="checkbox"/> 0007
RK40	N - No	<input type="checkbox"/> 033A
	P - Yes	<input type="checkbox"/> 033B
RKCL40	N - No	<input type="checkbox"/> 032V
	P - Yes	<input type="checkbox"/> 0008
RKCLB40	N - No	<input type="checkbox"/> 0504

2. Enter the numbers/letters from the selections above into the table below.

The resulting "Final Part Number" is used when ordering reader.

Reader Model		125 KHz	13.56 MHz	Communication	Wiring	HW Rev	Color	Keypad	Config Setting
Example	900	N	H	R	T	E	K	0	032Y
Final Part Number				R		E	K		

3. Place an order.

To place an order for this product, authorized channel partners may submit a purchase order to HID Global Customer Service.

Contact information is available at: www.hidglobal.com/customer-service.

Need credentials? Credentials supported by this reader model includes (depending on options chosen above):

- [Mobile IDs](#)
- [iCLASS Seos](#)
- [iCLASS SE](#)
- [iCLASS](#)
- [HID Prox](#)
- [MIFARE DESFire EV1](#)
- [MIFARE Classic](#)



pivCLASS Reader - Wiegand or OSDP

Application: Designed to support FIPS 201 credentials and communicate to traditional intelligent controller using Wiegand or OSDP protocol
Technologies Supported: FIPS 201 credentials such as PIV, CIV, TWIC, CAC, and FRAC and a wide variety of contactless credentials

1. Select one option from each section below:

Reader Model (Select one model)



900 - Model R10 - Designed for door applications requiring a small footprint card reader.



921 - Model RK40 - Designed for door applications requiring standard wall switch mounting.



920 - Model R40 - Designed for door applications requiring standard wall switch mounting.



923 - RKCL40 - Combination, contact plus contactless reader with keypad and LCD.

125 KHz Credential Support (Select one option)

- N - No 125 KHz support
- P - Support for HID Prox, AWID and EM4102 (32 bit)

13.56 MHz credential support (Select one option)

- H - Contactless. Supports PKI-Based FIPS 201 Credentials including PIV, PIV-I, CIV, CAC, TWIC and FRAC. This option is only available for models R10, R40 and RK40.
- P - Contactless + Contact. Supports PKI-Based FIPS 201 Credentials including PIV, PIV-I, CIV, CAC, TWIC and FRAC. FIPS 201 typecards can be read using either the contact or contactless card interface. This option is only available for model RKCL40.

Controller Communication (Select one option)

- R - Wiegand; Configurable to support RS-485 full duplex for communication with pivCLASS Authentication Module (PAM)
- P - Wiegand or OSDP via RS-485 half duplex; selectable through configuration. Not available for model with RKCL40.

Controller Connection (Select one option)

- N - Pigtail
- T - Terminal strip

Hardware Revision

- E - Revision E

Color

- K - Black

iCLASS Support/Keypad (Select one option)

- 0 - Standard v1 - Reads credentials with default HID keys including standard iCLASS and/or iCLASS SR.
- E - HID Elite - Reads credentials with HID Elite keys, including iCLASS and iCLASS SR, and/or Mobile IDs. *Key reference (ICE or MOB) required at time of order.*

Configuration Setting

Obtaining individual pivCLASS reader configuration settings requires the use of the online [Configuration Guide](#).

2. Enter the numbers/letters from the selections above into the table below.

The resulting "Final Part Number" is used when ordering reader.

Reader Model	125 KHz	13.56 MHz	Communication	Wiring	HW Rev	Color	Keypad	Config Setting	
Example	900	N	H	R	T	E	K	0	xxxx
Final Part Number				R		E	K		

3. Place an order.

To place an order for this product, authorized channel partners may submit a purchase order to HID Global Customer Service.

Contact information is available at: <http://www.hidglobal.com/customer-service>

Need credentials? This reader could support (depending on options chosen above) the following credentials:

- [iCLASS Seos](#)
- [iCLASS](#)
- [HID Prox](#)
- [MIFARE DESFire EV1](#)
- [MIFARE Classic](#)

iCLASS SE U90 - UHF Long Range Reader

Application: Designed for vehicle access control installations which require long range authentication and high throughput

Technologies Supported: Ultra High Frequency (UHF) EPC GEN 2

1. Select one option from each section below to construct part number:

Reader Model (Select one model)



RDRSEU90 - Model U90 - Contactless Smart Card Long Range Reader: Surface or Pole Mount.

Antenna Code (Select one option, see table below)

- 8
 9

Country	Operating Frequency	Antenna Code
Argentina	902 - 928MHz	9
Austria	865 - 868MHz	8
Australia	915 - 928MHz	9
Belgium	865 - 868MHz	8
Brazil	902 - 928MHz	9
Bulgaria	865 - 868MHz	8
Canada	902 - 928MHz	9
China	921 - 924MHz	9
Columbia	902 - 928MHz	9
Croatia	865 - 868MHz	8
Cyprus	865 - 868MHz	8
Czech Republic	865 - 868MHz	8
Denmark	865 - 868MHz	8

Country	Operating Frequency	Antenna Code
Estonia	865 - 868MHz	8
Finland	865 - 868MHz	8
France	865 - 868MHz	8
Germany	865 - 868MHz	8
Greece	865 - 868MHz	8
Hungary	865 - 868MHz	8
India	865 - 867MHz	8
Ireland	865 - 868MHz	8
Italy	865 - 868MHz	8
Latvia	865 - 868MHz	8
Lithuania	865 - 868MHz	8
Luxembourg	865 - 868MHz	8
Malta	865 - 868MHz	8

Country	Operating Frequency	Antenna Code
Mexico	902 - 928MHz	9
Netherlands	865 - 868MHz	8
New Zealand	921.5 - 928MHz	9
Poland	865 - 868MHz	8
Portugal	865 - 868MHz	8
Romania	865 - 868MHz	8
Slovakia	865 - 868MHz	8
Slovenia	865 - 868MHz	8
Spain	865 - 868MHz	8
Sweden	865 - 868MHz	8
United Arab Emirates	865 - 868MHz	8
United Kingdom	865 - 868MHz	8
United States	902 - 928MHz	9

Color

K - Black

Keypad (Select one option)

NOTE: Keypad is factory-configured only and cannot be configured in the field, via web interface or configuration cards.

- 0 - Standard Keypad
 E - HID Elite keypad - reads only HID Elite credentials with corresponding keypad. Line item on PO requires ICE reference number.

2. Enter the numbers/letters from the selections above into the table below.

The resulting "Final Part Number" is used when ordering reader.

Product Class	Product Sub Class	Base Reader	Antenna Code	Color	Keypad	Configuration Setting	
Example	RDR	SE	U90	8	K	0	0000
Final Part Number	RDR	SE	U90		K		0000

3. Place an order.

To place an order for this product, authorized channel partners may submit a purchase order to HID Global Customer Service.

Contact information is available at: <http://www.hidglobal.com/customer-service>.

Need credentials? This reader supports the following credentials:

- [UHF cards](#)
- [UHF + iCLASS cards](#)



iCLASS SE Reader Accessories

Programming Cards

Use these cards for customer reader configuration. Readers may be reconfigured to a target configuration by applying the correct target configuration. Use the following link to access the iCLASS SE Configuration Worksheet www.hidglobal.com/node/19914 to determine the exact configuration required. Apply changes to the reader security using programming cards. Contact HID Technical Support (www.hidglobal.com/support) to ensure selecting the proper settings.

Description	Part Number		
	Base Part No.	HID Elite (E) or Standard Security (0 or 2)	Configuration Settings ¹
Reader Configuration Cards			-XXXX = Specific configuration
Reconfigure reader to factory configuration settings (does not reconfigure reader admin or credential keys)	SEC9X-CRD-	E = HID Elite Key ² 0 = Standard-1 key or standard-2 key ²	-0000 = Factory configuration (Rx models) -0001 = Factory configuration (RPx models) -0002 = Factory configuration (RKx models) -0003 = Factory configuration (RPKx models)
HID Elite Upgrade Cards³ Setup iCLASS SE or multiCLASS SE® readers for HID Elite credential keys or Reader admin keys	SEC9X-CRD-	E = HID Elite Key ⁴ E = HID Elite Key ²	-P000 = HID Elite reader admin keys -P001 = HID Elite credential keys
HID Elite Downgrade Cards³ Setup iCLASS SE or multiCLASS SE readers for standard credential keys or reader admin keys	SEC9X-CRD-	E = HID Elite Key ² 0 = Standard-1 key or standard-2 key	-P002 = Standard reader admin keys -P003 = Standard-1 credential keys -P004 = Standard-2 credential keys

¹ Configuration Settings

All standard readers ship with the following features - 13.56MHz interpreter "T" enabled, Wiegand "N" enabled, and Standard-1 "0" security keys enabled. ANY other option selected requires a specific configuration EXTENSION. To order non-standard configuration options, use the following link to access the iCLASS SE Configuration Worksheet <https://www.hidglobal.com/node/19914>. Your HID Global Support or Sales representative can help you determine your final configuration.

Standard configuration includes: LED normally Red + Reader beeps / flashes LED green on card read + Intelligent Power Management = Off + Keypad Output is 4-bit (if keypad reader)

Note: Reader configuration cards change settings in an additive fashion. Configuration card settings only overwrite old settings for the options selected. Reader settings that have not been selected for the configuration retain their original values.

To reset reader settings to factory defaults, use a factory default configuration card first, then apply the new configuration with the provided reader configuration card.

² Keys

Specify HID Elite "E" or Standard-1/Standard-2 "0" based upon keys ALREADY LOADED in the reader that needs to be configured.

³ HID Elite Upgrade and Downgrade Cards

Reader admin keys and reader credential keys must both be changed to upgrade or downgrade to or from Elite. A separate card is required for reader admin keys and reader credential keys. A Reader Configuration Card with specific configuration extension SEC9X-0/E-XXXX or SEC9X-0/E-XXX(0, 1, 2, 3) is also be required to modify configuration options other than Elite keys, for example modification of 125 kHz or 13.56 MHz interpreters.

⁴ Keys

Specify HID Elite "E" based upon HID Elite keys TO BE LOADED in the reader that needs to be configured.

Accessories

The following provides accessories that can be ordered separately for your iCLASS SE and multiCLASS SE readers.

Part Number	Description
Mounting Plates, Spacers, Screws and Accessory Kits	
MDP-00354	R10 / RP10 (or equivalent sized model) Mini Mullion Reader Mounting Plate, Black
6309-103-01	R15 / RP15 (or equivalent sized model) Mullion Reader Mounting Plate, Black
6403-109-01	R40 / RP40 (or equivalent sized model) Wall Switch Reader Mounting Plate, Black
6094-101-01	RK40 / RPK40 (or equivalent sized model) Wall Switch Keypad Reader Mounting Plate, Black
6132AKB	R10 / RP10 (or equivalent sized model) Reader Spacer, 12.7mm (0.5 in), Black
6132AKC	R15 / RP15 (or equivalent sized model) Reader Spacer, 12.7mm (0.5 in), Black
6132AKT	R40 / RP40 (or equivalent sized model) Reader Spacer, 12.7mm (0.5 in), Black
6132AKU	RK40 / RPK40 (or equivalent sized model) Reader Spacer, 12.7mm (0.5 in), Black
6132AKE	R40 / RP40 (or equivalent sized model) Reader Spacer, 25.4mm (1.0 in), Black
6132AK	RK40 / RPK40 (or equivalent sized model) Reader Spacer, 25.4mm (1.0 in), Black
6132AKR	RM40 / RMK40 (or equivalent sized model) Reader Spacer, Angled, Black
6132AKP	RM40 / RMK40 (or equivalent sized model) Reader Spacer, 25.4mm (1.0 in), Black
6715-305-01	R95A Reader, Cover Assembly, Décor, Euro, White
6715-305-04	R95A Reader, Cover Assembly, Décor, Euro, Black
MDP-00038	R95A Reader, Cover Assembly, Décor, Euro, Grey
400-2D71-06	High Security Screw, Spanner
6706-303-03	Pigtail Accessory Kit (includes terminal blocks, screws, and installation guide)
6706-303-04	Terminal Reader Accessory Kit (includes terminal blocks, screws, and installation guide)
MDP-01033	multiCLASS SE Mag Stripe RM40 mounting plate replacement kit
MDP-01034	multiCLASS SE Mag Stripe RMK40 mounting plate replacement kit
MDP-01035	multiCLASS SE Mag Stripe RM40/RMK40 magnetic head replacement kit
6132AKB-M	R10 / RP10 BLE Reader Spacer, 12.7mm (0.5 in), Metallic Insert, Black
6132AKC-M	R15 / RP15 BLE Reader Spacer, 12.7mm (0.5 in), Metallic Insert, Black
6132AKT-M	R40 / RP40 BLE Reader Spacer, 12.7mm (0.5 in), Metallic Insert, Black
6132AKE-M	R40 / RP40 BLE Reader Spacer, 25.4mm (1.0 in), Metallic Insert, Black
6132AKU-M	RK40 / RPK40 BLE Reader Spacer, 12.7mm (0.5 in), Metallic Insert, Black
MME-00118	R10 / RP10 BLE Reader Metallic Insert with Adhesive (order in conjunction with spacer or mounting plate)
MME-00119	R15 / RP15 BLE Reader Metallic Insert with Adhesive (order in conjunction with spacer or mounting plate)
MME-00121	R40 / RP40 BLE Reader Metallic Insert with Adhesive (order in conjunction with spacer or mounting plate)
MME-00122	RK40 / RPK40 BLE Reader Metallic Insert with Adhesive (order in conjunction with spacer or mounting plate)

IP65 Upgrade Kit

For Upgrading iCLASS SE Readers to IP65 Ingress Protection in the Field IP65 Kit Description (10) Pieces Per Kit	Part Number
IP65 Gasket Kit, (10) pcs per kit. For use with model R10	IP65GSKT-R10
IP65 Gasket Kit, (10) pcs per kit. For use with model R15	IP65GSKT-R15
IP65 Gasket Kit, (10) pcs per kit. For use with model R40	IP65GSKT-R40
IP65 Gasket Kit, (10) pcs per kit. For use with model RK40	IP65GSKT-RK40

UHF Credential Card Holder

For Proper Placement and Attachment of UHF Credentials to Inside of Car Windshield	Part Number
Windshield Mount, suction cup, adhesive for ID 1 style credential, Blue (Qty 10)	WSHLDMT-BLU
Windshield Mount, suction cup, adhesive for ID 1 style credential, Clear (Qty 10)	WSHLDMT-CLR
Windshield Mount, suction cup, adhesive for ID 1 style credential, White (Qty 10)	WSHLDMT-WHT
Windshield Mount, suction cup, adhesive for ID 1 style credential, Blue (Qty 250)	WSHLDMT-BLU-BULK
Windshield Mount, suction cup, adhesive for ID 1 style credential, Clear (Qty 250)	WSHLDMT-CLR-BULK
Windshield Mount, suction cup, adhesive for ID 1 style credential, White (Qty 250)	WSHLDMT-WHT-BULK
Suction Cups for WSHLDMT - Kit contains (200) cups	WSHLDMT-CUPS
Double sided tape for WSHLDMT - Kit contains (200) pieces	WSHLDMT-TAPE



iCLASS Readers

iCLASS SE has superseded the majority of iCLASS reader functionality. The remaining specialty models and applications continue to exist on the iCLASS line until an SE replacement is made available.

bioCLASS Biometric Reader/Enroller - 6180 / 6188

Card Reader Description	Base Part No.	Current Rev. No.*	Color Options	Hardware Options	Configuration Setting Options ¹	iCLASS Security ²	MIFARE CSN ³ Wiegand Output Mode	Keypad Configuration Setting Options ⁴	Optional Custom
iCLASS RKL57 Contactless Smart Card Biometric Reader/Enroller: Reader with LCD, Keypad, and fingerprint biometric module US, European and Asian Back Box Mount (Wiegand Output) Read Only, RoHS Compliant	6180	B	K = Black	R = Reader/Enroller ⁵	00 01 02 03 04 05 06 07	0 1 C D	0 = N/A	00 09 10 11 14 19 20 22	-XXXX Y
iCLASS RKL57 Contactless Smart Card Reader: with LCD, Keypad, and fingerprint biometric module US, European and Asian Back Box Mount (Wiegand Output) Read Only, RoHS Compliant (C&D Output) Requires reader/enroller or CP575A for enrolling fingerprint templates.	6180 6188	B	K = Black	T = Terminal Strip	00 01 02 03 04 05 06 07	0 1 C D	0 = N/A	00 09 10 11 14 19 20 22	-XXXX Y

*Revision numbers and availability are subject to change without notice. Consult factory for availability.

¹ Configuration Setting Options are as follows (Factory or Field Configurable):

00 = Beep on, LED normally red, reader flashes green on tag read 03 = Beep off, LED normally off, reader flashes green on tag read 06 = Beep on, LED normally off, host must flash red and/or green
 01 = Beep off, LED normally red, reader flashes green on tag read 04 = Beep on, LED normally red, host must flash green 07 = Beep off, LED normally off, host must flash red and/or green
 02 = Beep on, LED normally off, reader flashes green on tag read 05 = Beep off, LED normally red, host must flash green

² iCLASS Security options (Factory or Field Configurable)

0 = Standard: protects access and biometric applications (Reads/Enrolls all iCLASS cards with unique keys diversified from HID master key)
 1 = HID Elite: protects access and biometric applications (Reads/Enrolls only iCLASS cards with site-specific HID Elite key: consult factory for availability)
 C = Standard with Open Collector Tamper enabled
 D = HID Elite with Open Collector Tamper enabled

³ MIFARE Card Serial Number (CSN) Wiegand Output Modes are as follows (Factory or Field Configurable). Refer to the "iCLASS Reader Wiegand Output Configuration Guide" for more details.

(SETTING NOT APPLICABLE WITH HID ELITE ORDERS. HID ELITE READERS DO NOT READ MIFARE CSN.)
 0 = 32 bit 1 = 32 bit reverse (Same as 6055A and 6055BXX0011) 2 = 26 bit 3 = 34 bit 4 = 40 bit 5 = 37 bit 6 = 56 bit

⁴ Keypad data is output via Wiegand cable. Reader processes keystrokes. Configuration setting options:

00 = Buffer one key, no parity, 4 bit message 09 = Buffer one key, add compliment, 8 bit message (Dorado) 10 = Buffer six keys and add parity
 11 = Buffer one key and add parity 14 = Buffer one to five keys (Standard 26 bit output) 19 = Buffer four keys and add parity
 20 = Single Key buffering 23 = Buffer one to 11 keys

⁵ In addition to RKL57 reader only (6180BKT), this part provides additional enrollment capabilities and multi-lingual support. Reader/Enroller is field configurable for one of the following behaviors: reader/enroller, reader-only or enroller-only, and field configurable for one of 10 languages (see datasheet for more information). This product replaces CP575 fingerprint template enroller (no longer available).

iCLASS LCD Reader - 6170 / 6178

Card Reader Description	Base Part No.	Current Rev. No.*	Color Options	Hardware Options	Configuration Setting Options ¹	iCLASS Security ²	MIFARE CSN ³ Wiegand Output Mode	Keypad Configuration Setting Options ⁴	Optional Custom ⁵
iCLASS RKL55 Contactless Smart Card Reader: Read, with LCD and Keypad US, European and Asian Back Box Mount (Wiegand) Wiegand or Clock and Data output (C&D) RoHS Compliant	6170 6178	B	K = Black	T = Terminal Strip	00 01 02 03 04 05 06 07	0 1 C D	0 1 2 3 4 5 6 Z	00 09 10 11 14 19 20 22 23	-XXXX Y

*Revision numbers and availability are subject to change without notice. Consult factory for availability.

¹ Configuration Setting Options are as follows (Factory or Field Configurable):

00 = Beep on, LED normally red, reader flashes green on tag read 03 = Beep off, LED normally off, reader flashes green on tag read 06 = Beep on, LED normally off, host must flash red and/or green
 01 = Beep off, LED normally red, reader flashes green on tag read 04 = Beep on, LED normally red, host must flash green 07 = Beep off, LED normally off, host must flash red and/or green
 02 = Beep on, LED normally off, reader flashes green on tag read 05 = Beep off, LED normally red, host must flash green

² iCLASS Security Options (Factory or Field Configurable): See Application Note Number 28 for additional information on Key Management.

0 = Standard (Reads all iCLASS cards with unique keys diversified from HID master key)
 1 = Custom options (Reads only iCLASS cards with unique keys diversified from matching site specific master key; consult factory for availability)
 C = Standard with Open Collector Tamper enabled
 D = Custom with Open Collector Tamper enabled

³ MIFARE Card Serial Number (CSN) Wiegand Output Modes are as follows (Factory or Field Configurable). Refer to the "iCLASS Reader Wiegand Output Configuration Guide" for more details. (SETTING NOT APPLICABLE WITH HID ELITE ORDERS. HID ELITE READERS DO NOT READ MIFARE CSN.)

0 = 32 bit 1 = 32 bit reverse (Same as 6055A and 6055BXX0011) 2 = 26 bit 3 = 34 bit 4 = 40 bit 5 = 37 bit 6 = 56 bit Z = CSN Suppressed

⁴ Keypad data is output via Wiegand cable. Reader processes keystrokes. Configuration setting options:

00 = Buffer one key, no parity, 4 bit message 09 = Buffer one key, add compliment, 8 bit message (Dorado) 10 = Buffer six keys and add parity
 11 = Buffer one key and add parity 14 = Buffer one to five keys (Standard 26 bit output) 19 = Buffer four keys and add parity
 20 = Single Key buffering 23 = Buffer one to 11 keys

⁵ Contact Factory for pricing, availability, and minimum order quantity.

RoHS compliant Readers are appropriately marked on reader and box. (RoHS or Restriction of Hazardous Substances Directive restricts certain hazardous substances in electrical and electronic equipment.)



iCLASS Read/Write Reader - 6141 / 6111 / 6121 / 6131 / 6171

Card Reader Description	Base Part No.	Current Rev. No.*	Color Options	Hardware Options ¹	Configuration Setting Options ²	iCLASS Security ³	MIFARE CSN ⁴ Wiegand Output Mode	Keypad Configuration Setting Options ⁵	Optional Custom ⁶
iCLASS RW150 Contactless Smart Card Reader/Writer: Read/Write Mullion Mount Wiegand and RS-232 or RS-485 or USB or UART (RoHS Compliant)	6141	C	G = Gray	T = RS232 4 = RS485(Full-Duplex) M = RS485(Half-Duplex) U = USB B = UART to UART	00 01 02 03 04 05 06 07	0 1 C D	0 1 2 3 4 5 6 Z	For Keypad readers only	-XXXX Y
iCLASS RW300 Contactless Smart Card Reader/Writer: Read/Write European and Asian Back Box Mount Wiegand and RS-232 or RS-485 or USB or UART (RoHS Compliant)	6111	C	G = Gray K = Black	T = RS232 4 = RS485(Full-Duplex) M = RS485(Half-Duplex) U = USB B = UART to UART	00 01 02 03 04 05 06 07	0 1 C D	0 1 2 3 4 5 6 Z	For Keypad readers only	-XXXX Y
iCLASS RW400 Contactless Smart Card Reader/Writer: Read/Write US, European and Asian Back Box Mount Wiegand and RS-232 or RS-485 or USB or UART (RoHS Compliant)	6121	C	K = Black	T = RS232 4 = RS485(Full-Duplex) M = RS485(Half-Duplex) U = USB B = UART to UART	00 01 02 03 04 05 06 07	0 1 C D	0 1 2 3 4 5 6 Z	For Keypad readers only	-XXXX Y
iCLASS RWK400 Contactless Smart Card Reader/Writer: Read/Write, with Keypad US, European and Asian Back Box Mount (RoHS Compliant) Wiegand Output, and/or RS-232/422 or USB or UART	6131	C	G = Gray K = Black	T = RS232 4 = RS485(Full-Duplex) M = RS485(Half-Duplex) U = USB B = UART to UART	00 01 02 03 04 05 06 07	0 1 C D	0 1 2 3 4 5 6 Z	00 09 10 11 14 19 20 22 23	-XXXX Y
iCLASS RWKL550 Contactless Smart Card Reader/Writer: Read/Write, with LCD and Keypad US, European and Asian Back Box Mount Wiegand Output, and/or RS-232, RS-485, USB or UART (RoHS Compliant)	6171	B	K = Black	T = RS232 4 = RS485(Full-Duplex) M = RS485(Half-Duplex) U = USB B = UART to UART	00 01 02 03 04 05 06 07	0 1 C D	0 1 2 3 4 5 6 Z	00 09 10 11 14 19 20 22 23	-XXXX Y

*Revision numbers and availability are subject to change without notice. Consult factory for availability.

¹ All the following communication modules allow host driven communication using the iCLASS Serial Protocol. All the following communication modules (except USB) allow for card ID reporting instantiated by the reader. For multi-drop functionality, see iCLASS OSDP Readers. All Reader/Writers are terminal strip readers. RoHS compliant Readers are appropriately marked on reader and box. (RoHS or Restriction of Hazardous Substances Directive restricts certain hazardous substances in electrical and electronic equipment.)

² Configuration Setting Options are as follows (Factory or Field Configurable):

- 00 = Beep on, LED normally red, reader flashes green on tag read
- 01 = Beep off, LED normally red, reader flashes green on tag read
- 02 = Beep on, LED normally off, reader flashes green on tag read
- 03 = Beep off, LED normally off, reader flashes green on tag read
- 04 = Beep on, LED normally red, host must flash green
- 05 = Beep off, LED normally red, host must flash green
- 06 = Beep on, LED normally off, host must flash red and/or green
- 07 = Beep off, LED normally off, host must flash red and/or green

³ iCLASS Security options (Factory or Field Configurable): See Application Note Number 28 for additional information on Key Management.

- 0 = Standard (Reads all iCLASS cards with unique keys diversified from HID master key)
- 1 = HID Elite Key (Reads only iCLASS cards with unique keys diversified from matching site specific master key; consult factory for availability)
- C = Standard with Open Collector Tamper enabled
- D = Custom with Open Collector Tamper enabled

⁴ MIFARE Card Serial Number (CSN) Wiegand Output Modes are as follows (Factory or Field Configurable). Refer to the "iCLASS Reader Wiegand Output Configuration Guide" for more details. (SETTING NOT APPLICABLE WITH HID ELITE ORDERS. HID ELITE READERS DO NOT READ MIFARE CSN.)





- 0 = 32 bit
- 1 = 32 bit reverse (Same as 6055A and 6055BXX0011)
- 2 = 26 bit
- 3 = 34 bit
- 4 = 40 bit
- 5 = 37 bit
- 6 = 56 bit
- Z = CSN Suppressed

⁵ Keypad data is output via Wiegand cable. Reader processes keystrokes. Configuration Setting options:

- 00 = Buffer one key, no parity, 4 bit message
- 01 = Buffer one key, add parity
- 02 = Buffer one key and add parity
- 03 = Buffer one key, add compliment, 4 bit message (Dorado)
- 04 = Buffer one key and add parity
- 05 = Buffer one to five keys (Standard 26 bit output)
- 06 = Buffer one to five keys (Standard 26 bit output)
- 07 = Buffer one to five keys (Standard 26 bit output)
- 08 = Buffer one to five keys (Standard 26 bit output)
- 09 = Buffer one key, add compliment, 8 bit message (Dorado)
- 10 = Buffer six keys and add parity
- 11 = Buffer one key and add parity
- 12 = Buffer one to five keys (Standard 26 bit output)
- 13 = Buffer one to five keys (Standard 26 bit output)
- 14 = Buffer one to five keys (Standard 26 bit output)
- 15 = Buffer one to five keys (Standard 26 bit output)
- 16 = Buffer one to five keys (Standard 26 bit output)
- 17 = Buffer one to five keys (Standard 26 bit output)
- 18 = Buffer one to five keys (Standard 26 bit output)
- 19 = Buffer four keys and add parity
- 20 = Single Key buffering
- 21 = Buffer one to 11 keys
- 22 = Buffer one to 11 keys
- 23 = Buffer one to 11 keys

⁶ Contact Factory for pricing, availability, and minimum order quantity.

EDGE® Reader - EDGE EVO Solo

EDGE EVO® Solo Model and Description	Image	Base Part	Rev	Color	Hardware Configuration	Additional Configuration
<p>ESH400-K Standard Controller Single door, IP-based controller for single-door solo-based system. Single physical package. Door inputs/outputs are 4 external inputs, 2 outputs; on-board optical tamper (standard mount). One Wiegand / Clock-and-Data reader interface. For use indoor or outside in weatherproof enclosure. US single-gang, US double-gang or EU/APAC 60mm mount.</p>		83000	C	K = Black	E = Externally-mounted reader	
<p>ESHR40-K Standard Controller / Reader and Module Single door, IP-based controller with integrated R40 iCLASS reader for single-door solo-based system. Two physical packages; IP-based reader for mount at access point and "Door Module" with interface to 4 external inputs, 2 outputs; optical tamper. Second reader possible an additional IO interface module (EWM-M or EDWM-M). For indoor use. Door Module mounted in secure location. US Single-gang or EU/APAC 60mm mount.</p>		83120	C	K = Black	I = Integrated controller / reader, with segregated module (separate physically installed device) containing discrete IO	000 = LED normally Red, Flash Green and beep on card read
<p>ESHR40-L Single-Output Controller / Reader and Module Single door, IP-based controller with integrated R40 iCLASS reader for single-door solo-based system. Two physical packages; IP-based reader for mount at access point and "Lock Module" with interface single (1) lock output. For indoor use. Door Module mounted behind reader in US Single-gang box, in hollow door frame or other secure location. Reader is US Single-gang or EU/APAC 60mm mount.</p>		83120	C	K=Black	L = Integrated controller / reader, with segregated module (separate physically installed device) containing single discrete lock output	000 = LED normally Red, Flash Green and beep on card read
<p>ESHRP40-K Standard Controller / Reader and Module Single door, IP-based controller with integrated RP40 multiCLASS® reader for single-door solo-based system. Two physical packages; IP-based reader for mount at access point and "Door / Wiegand Module" with interface to 4 external inputs, 2 outputs and one Wiegand / Clock-and-Data reader interface; Second reader possible using Wiegand reader. Optical tamper (standard mount). For indoor use. Door / Wiegand Module mounted in secure location. US Single-gang or EU/APAC 60mm mount.</p>		83125	C	K = Black	I = Integrated controller / reader, with segregated module (separate physically installed device) containing discrete IO and Wiegand reader interface for second reader	000 = LED normally Red, Flash Green and beep on card read
<p>EWM-M Wiegand Module The "Wiegand Module" enables controller interface to one (1) Wiegand / Clock-and-Data reader interface. For use indoor or outside in weatherproof enclosure.</p>		83360	A	K = Black	M = Mountable on US single-gang, EU / APAC 60mm electrical box	

For custom Indala Prox support, add a "-D" to the end of the EHR40-K, EHR40-L or EHRP40-K part number, and specify the Indala format to be programmed into the reader.

iCLASS Reader Accessories

Part No.	Description
iCLASS Reader Accessories	
6303-104-01	Mini-Mullion Reader Mounting Plate for iCLASS SE R10, RP10 and iCLASS RW100
6309-103-01	Mullion Reader Mounting Plate for iCLASS SE R15 and RP15
6402-103-01	EU/Asian Reader Mounting Plate for iCLASS RW300
6403-109-01	Wall Switch Reader Mounting Plate for iCLASS SE R40, RP40 and iCLASS RW400
6094-101-01	Wall Switch Keypad Reader Mounting Plate for iCLASS SE RK40, RPK40 and iCLASS RWK400
6132AKB	Mini-Mullion Reader Spacer for iCLASS SE R10, RP10 and iCLASS RW100, Black
6132AKC	Mullion Reader Spacer for iCLASS SE R15, RP15, Black
6132AKD	EU/Asian Reader Spacer for iCLASS RW300, Black
6132AKE	iCLASS Wall Switch Reader Spacer, Black (works with R40, RP40, RW400)
6132AK	iCLASS Wall Switch Keypad Reader Spacer, Black (works with RK40, RPK40, RWK400)
400-2D71-06	iCLASS reader security screw (Qty 1)



HID Proximity Readers

ProxPoint Plus Proximity Reader - 6005 / 6008

Card Reader Description	Base Part No.	Current Rev. No.*	Color Options	Hardware Options	Configuration Setting Options ¹	Custom ²
ProxPoint® Plus Proximity Reader with Wiegand output with Clock and Data output	6005 6008	B B	G = Classic Charcoal Gray B = Classic Beige W = Classic White K = Classic Black 1 = Designer Black 2 = Designer Charcoal Gray 4 = Designer Wave Blue 5 = Designer White	B = Pigtail (18 inches/45.7 cm) L = Long Pigtail (9 feet/3 meters) ³	00 04 01 05 02 06 03 07	XXXX Y

*Revision numbers and availability are subject to change without notice.

Notes:

¹ Configuration Setting Options are as follows (factory programmed):

- | | |
|---|---|
| 00 = Beep on, LED normally red, reader flashes green on tag read | 04 = Beep on, LED normally red, host must flash green |
| 01 = Beep off, LED normally red, reader flashes green on tag read | 05 = Beep off, LED normally red, host must flash green |
| 02 = Beep on, LED normally off, reader flashes green on tag read | 06 = Beep on, LED normally off, host must flash red and/or green |
| 03 = Beep off, LED normally off, reader flashes green on tag read | 07 = Beep off, LED normally off, host must flash red and/or green |

² Consult Factory

³ An optional 9 foot pigtail is available through our HID European office and can also be available in the Americas and Asia Pacific regions via special order of 2,500 unit minimum order quantity. Call the HID factory for pricing and lead-times.

To order, specify the following:

Card Reader Description	Base Part No.	Current Rev. No.*	Color Options	Hardware Options	Configuration Setting Options	Custom



MiniProx Proximity Reader - 5365 / 5368

Card Reader Description	Base Part No.	Current Rev. No.*	Color Options	Hardware Options	Configuration Setting Options ¹	Custom ²
MiniProx [®] Proximity Reader with Wiegand output with Clock and Data output	5365 5368	E E	G = Classic Charcoal Gray B = Classic Beige W = Classic White K = Classic Black 1 = Designer Black 2 = Designer Charcoal Gray 4 = Designer Wave Blue 5 = Designer White	P = Pigtail (18 inches/45.7 cm) T = Terminal Strip H = Hazardous back box ³	00 04 01 05 02 06 03 07	XXXX Y

*Revision numbers and availability are subject to change without notice.

Notes:

¹ Configuration Setting Options are as follows (factory programmed):

- | | |
|---|---|
| 00 = Beep on, LED normally red, reader flashes green on tag read | 04 = Beep on, LED normally red, host must flash green |
| 01 = Beep off, LED normally red, reader flashes green on tag read | 05 = Beep off, LED normally red, host must flash green |
| 02 = Beep on, LED normally off, reader flashes green on tag read | 06 = Beep on, LED normally off, host must flash red and/or green |
| 03 = Beep off, LED normally off, reader flashes green on tag read | 07 = Beep off, LED normally off, host must flash red and/or green |

² Consult Factory

³ The hazardous back box option MiniProx is available in gray Terminal Strip only.

To order, specify the following:

Card Reader Description	Base Part No.	Current Rev. No.*	Color Options	Hardware Options	Configuration Setting Options	Custom

ProxPro Family Proximity Reader - 5455 / 5458 / 5355 / 5352 / 5358

ProxPro Family Card Reader Description	Base Part No.	Current Rev. No.*	Color Options	Hardware Options	Configuration Setting Options ¹	Custom ²
ProxPro II Proximity Reader with Wiegand output with Clock & Data Output	5455 5458	B	G = Charcoal Gray B = Beige W = White K = Black	N = No Keypad, Pigtail (18 inches/45.7 cm)	00 04 01 05 02 06 03 07	XXXX Y
ProxPro Proximity Reader ^{5,6} with Wiegand output with Clock & Data Output	5355 5358	A	G = Charcoal Gray B = Beige	N = No Keypad, Terminal Strip K = Keypad ³ , Terminal Strip S = Keypad ⁴ , Terminal Strip	00 09 10 11 14 19 20 21 23	XXXX Y
ProxPro Proximity Reader with Serial output ⁷	5352				00 09 10 11 14 19 20 21 23	

*Revision numbers and availability are subject to change without notice.

¹ ProxPro II Configuration Setting Options are as follows (factory programmed):

- | | |
|---|---|
| 00 = Beep on, LED normally red, reader flashes green on tag read | 04 = Beep on, LED normally red, host must flash green |
| 01 = Beep off, LED normally red, reader flashes green on tag read | 05 = Beep off, LED normally red, host must flash green |
| 02 = Beep on, LED normally off, reader flashes green on tag read | 06 = Beep on, LED normally off, host must flash red and/or green |
| 03 = Beep off, LED normally off, reader flashes green on tag read | 07 = Beep off, LED normally off, host must flash red and/or green |

² Consult Factory

³ ProxPro Reader with Keypad (Hardware Option K Version): data is outputted over shared Wiegand cable. Reader processes keystrokes.

⁴ ProxPro Reader with Keypad (Hardware Option S Version): (3 x 4 Matrix) requires additional 7 conductor keypad cable. Control panel processes keystrokes

⁵ ProxPro Configuration Setting options are as follows (factory programmed):

- | | |
|---|---|
| 00 = Buffer one key, no parity, 4 bit message | 14 = Buffer one to five keys (Standard 26 bit output) |
| 09 = Buffer one key, add compliment, 8 bit message (Dorado) | 19 = Buffer four keys and add parity |
| 10 = Buffer six keys and add parity | 20 = Single Key buffering |
| 11 = Buffer one key and add parity | 21 = Supervision Mode |
| | 23 = Buffer one to 11 keys |

⁶ ProxPro reader Configuration Settings are selected by the customer via dip switch settings. 00 = LED normally red, reader flashes green on tag reads.

⁷ ProxPro Serial output reads cards with up to 37-bit formats, and outputs RS232, RS422, and RS485.

Optional Glass Mount Kit for ProxPro and ProxPro II Readers = 5455AGM00.

To order specify the following:

Card Reader Description	Base Part No.	Current Rev. No.*	Color Options	Hardware Options	Configuration Setting Options	Custom



ThinLine II Proximity Reader - 5395 / 5398

Card Reader Description	Base Part No.	Current Rev. No.*	Color Options	Hardware Options	Configuration Setting Options ¹	Custom ²
ThinLine II® Proximity Reader with Wiegand output with Clock and Data output	5395 5398	C	G = Classic Charcoal Gray B = Classic Beige W = Classic White K = Classic Black 1 = Designer Black 2 = Designer Charcoal Gray 4 = Designer Wave Blue 5 = Designer White	1 = Pigtail (18 inches/45.7 cm)	00 04 01 05 02 06 03 07	XXXX Y

*Revision numbers and availability are subject to change without notice.

Notes:

¹ Configuration Setting Options are as follows (factory programmed):

- 00 = Beep on, LED normally red, reader flashes green on tag read
- 01 = Beep off, LED normally red, reader flashes green on tag read
- 02 = Beep on, LED normally off, reader flashes green on tag read
- 03 = Beep off, LED normally off, reader flashes green on tag read

- 04 = Beep on, LED normally red, host must flash green
- 05 = Beep off, LED normally red, host must flash green
- 06 = Beep on, LED normally off, host must flash red and/or green
- 07 = Beep off, LED normally off, host must flash red and/or green

² Consult Factory

To order specify the following:

Card Reader Description	Base Part No.	Current Rev. No.*	Color Options	Hardware Options	Configuration Setting Options	Custom



MaxiProx Proximity Reader - 5375

Card Reader Description	Base Part No.	Current Rev. No.*	Color Options	Hardware Options	Configuration Setting Options ¹	Custom ²
MaxiProx [®] Proximity Reader	5375	A	G = Charcoal Gray	N = None	00	XXXX Y

*Revision numbers and availability are subject to change without notice.

Notes:

¹ Configuration Setting 00 = LED normally red, reader flashes green on tag reads.

The MaxiProx reader configuration settings are selected by the customer via internal dip switch settings.

² Consult Factory

To order specify the following:

Card Reader Description	Base Part No.	Current Rev. No.*	Color Options	Hardware Options	Configuration Setting Options	Custom



EntryProx Proximity Reader - 4045

Card Reader Description	Base Part No.	Current Rev. No.*	Color Options	Hardware Options	Configuration Setting Options ¹	Custom ²
EntryProx™ Proximity Reader Stand-Alone Access Control Unit	4045	C	G = Charcoal Gray	N = None	U0	XXXX Y

*Revision numbers and availability are subject to change without notice.

Notes:

¹ Configuration Setting U0 = LED normally red, reader flashes green on tag reads.

² Consult Factory

To order specify the following:

Card Reader Description	Base Part No.	Current Rev. No.*	Color Options	Hardware Options	Configuration Setting Options	Custom

HID Proximity Reader Accessories

Part No.	Description
ProxPro Family	
5455AGM00	Glass Mount Kit, ProxPro and ProxPro II Readers
5350-113-01	Bezel, ProxPro Reader with Keypad (Rev. A) - Charcoal Gray
5350-113-02	Bezel, ProxPro Reader (Rev. A) - Charcoal Gray
5350-113-03	Bezel, ProxPro Reader with Keypad (Rev. A) - Beige
5350-113-04	Bezel, ProxPro Reader (Rev. A) - Beige
5355A-302-01	Cover, ProxPro w/Keypad Reader (Rev. A) - Charcoal Gray
5355A-302-02	Cover, ProxPro Reader (Rev. A) - Charcoal Gray
5355A-302-03	Cover, ProxPro w/Keypad Reader (Rev. A) - Beige
5355A-302-04	Cover, ProxPro Reader (Rev. A) - Beige
5350-101-01	Base, ProxPro Reader (Rev. A) - Charcoal Gray
5350-101-02	Base, ProxPro Reader (Rev. A) - Beige
5355A-306-01	ProxPro Keypad assembly upgrade, K Version, (Rev. A) - Gray Cover only
5355A-306-02	ProxPro Keypad assembly upgrade, K Version, (Rev. A) - Beige Cover only
5355A-306-03	ProxPro Keypad assembly upgrade, S Version, (Rev. A) - Gray Cover only
5355A-306-04	ProxPro Keypad assembly upgrade, S Version, (Rev. A) - Beige Cover only
5355A-306-05	ProxPro Keypad assembly upgrade, K Version, (Rev. A) - Gray Cover and Bezel
5355A-306-06	ProxPro Keypad assembly upgrade, K Version, (Rev. A) - Beige Cover and Bezel
5355A-306-07	ProxPro Keypad assembly upgrade, S Version, (Rev. A) - Gray Cover and Bezel
5355A-306-08	ProxPro Keypad assembly upgrade, S Version, (Rev. A) - Beige Cover and Bezel
5455-311-01	Cover, ProxPro II Reader (Rev. B) - Charcoal Gray (No Bezel Required)
5455-311-02	Cover, ProxPro II Reader (Rev. B) - Beige (No Bezel Required)
5455-311-03	Cover, ProxPro II Reader (Rev. B) - Black (No Bezel Required)
5455-311-04	Cover, ProxPro II Reader (Rev. B) - White (No Bezel Required)
30-0003-01	Rubber Keypad Cover, ProxPro Reader (Rev. A)
137-0005-11	Connector Feed Back Nut and Washer, ProxPro Reader (Rev. A)
MiniProx	
5365-371-01	Classic cover, MiniProx Reader (Rev. E) - Charcoal Gray
5365-371-02	Classic cover, MiniProx Reader (Rev. E) - Beige
5365-371-03	Classic cover, MiniProx Reader (Rev. E) - Black
5365-371-04	Classic cover, MiniProx Reader (Rev. E) - White
New Look ¹	
5365-372-01	Designer cover, MiniProx Reader (Rev. E) - Black
5365-372-02	Designer cover, MiniProx Reader (Rev. E) - Charcoal Gray
5365-372-04	Designer cover, MiniProx Reader (Rev. E) - Wave Blue
5365-372-05	Designer cover, MiniProx Reader (Rev. E) - White
ThinLine II	
5395-104-01	Classic cover, ThinLine II Reader (Rev. C) - White
5395-104-02	Classic cover, ThinLine II Reader (Rev. C) - Beige
5395-104-03	Classic cover, ThinLine II Reader (Rev. C) - Black

Part No.	Description
5395-104-04	Classic cover, ThinLine II Reader (Rev. C) - Charcoal Gray
New Look²	
5395-371-01	Designer cover, ThinLine II Reader (Rev. C) - Black
5395-371-02	Designer cover, ThinLine II Reader (Rev. C) - Charcoal Gray
5395-371-04	Designer cover, ThinLine II Reader (Rev. C) - Wave Blue
5395-371-05	Designer cover, ThinLine II Reader (Rev. C) - White
MaxiProx	
5370A-305-01	Cover, MaxiProx Reader (Rev. A) - Gray
5375-303-01	Accessory Kit, MaxiProx Reader (Old wiring Diagram) (Rev. A)
5375-313-01	Accessory Kit, MaxiProx Reader (New wiring Diagram) (Rev. A)
56-0002-01	MaxiProx Reader Rubber Gasket (Rev. A)
ProxPoint Plus	
6005-111-01	Classic cover, ProxPoint Plus Reader (Rev. B) - White
6005-111-02	Classic cover, ProxPoint Plus Reader (Rev. B) - Beige
6005-111-03	Classic cover, ProxPoint Plus Reader (Rev. B) - Black
6005-111-04	Classic cover, ProxPoint Plus Reader (Rev. B) - Charcoal Gray
New Look³	
6005-312-01	Designer cover, ProxPoint Plus Reader (Rev. B) - Black
6005-312-02	Designer cover, ProxPoint Plus Reader (Rev. B) - Charcoal Gray
6005-312-04	Designer cover, ProxPoint Plus Reader (Rev. B) - Wave Blue
6005-312-05	Designer cover, ProxPoint Plus Reader (Rev. B) - White
Other	
4045-390-03	EntryProx Spare Parts Accessories Kit
4045-303-01	EntryProx Reader Replacement Antenna
6020-302-01	Accessory Kit, HSM
33-0001-01	RELAY, 1.00A-24VDC, SPDT-1 FO
57-0001-02	Key Ring for ProxKey (Keyfob)

¹ MiniProx Covers will only fit MiniProx readers with removable covers series (Model # 5365E or later), and will NOT fit older versions with electronics potted into the cover (Model #s 5365A, 5365B, nor 5365C).

² ThinLine II Designer Covers will only fit ThinLine II readers (Model # 5395C or later), and will NOT fit ThinLine II readers (Model #s 5395A nor 5395B).

³ ProxPoint Plus Designer Covers will fit all ProxPoint Plus readers (Model # 6005B or later), and will NOT fit ProxPoint readers (Model # 6005A).

Indala Proximity Readers

Overview

Every part number consists of a base model number to indicate the type of product, and a letter or number to indicate each product option. Each product has a standard part number that includes default options, as indicated on the order guide. When an order is placed for a product, the base model number and all options must be specified. If you require any options that are different from the default options, you must also indicate those options at the time the order is placed. All part numbers must be complete to be accepted by HID's order entry system.

All reader orders must have the following information:

- BASE MODEL NUMBER
- STYLE
- READ RANGE
- TYPE
- COLOR
- OUTPUT FORMAT (*reader's format or format number must also be given at time of order*)

Advantage Series Reader - ASR 620

Part Number	Description	Notes
ASR-620++	Long Range Reader	
ASR-620++/L	Long Range Reader	w/10 foot (3 meter) cable

FlexPass™ Reader - FP Arch / Keypad

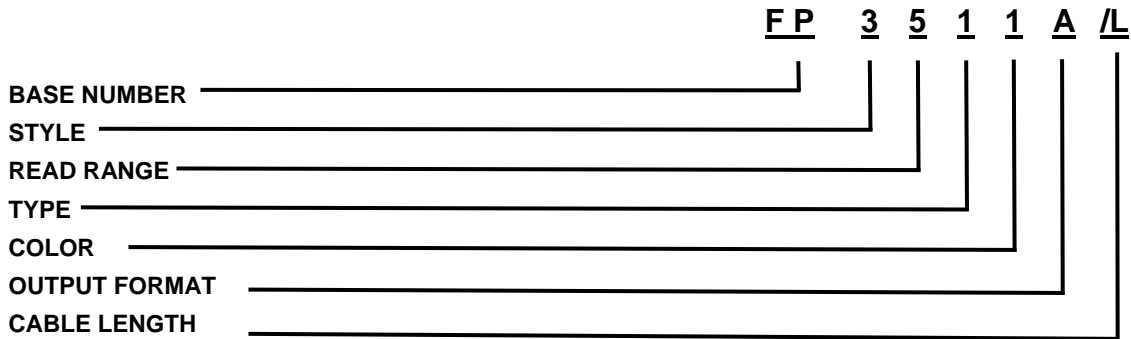

BASE NUMBER

FP = FlexPass (reader format required)

STYLE

- 3** = Arch
- 5** = Keypad
- 0** = Core Electronics Module

READ RANGE

- 5** = 5 in. (13 cm.) - available in STYLES: Arch, TYPES: Slim and Wall switch
- 2** = 12 in. (30 cm.) - available in STYLES: Arch TYPE: Midrange
- 0** = 4 in. (10 cm.) - available only in STYLE: Keypad; TYPE: Keypad

TYPE

- 1** = Slim - available in STYLES: Arch
- 2** = Wall switch - available in STYLES: Arch
- 3** = Midrange - available in STYLES: Arch
- 6** = Membrane Keypad - available only in STYLE: Keypad
- 0** = Module only

COLOR

- 1** = Black - available in STYLES: Arch TYPES: Slim, Wall switch, Midrange, Classic
- 0** = N/A

OUTPUT FORMAT

- Note:** Aside from choosing below, specify reader's format or format no. (e.g. 26-bit Wiegand or format no. 10022).
- A** = Standard Wiegand - available in all STYLES and TYPES
- S** = Serial - available in STYLES: Arch TYPE: Midrange
- B** = Buffered or 8-Bit Burst (must be specified) - available only in Keypad STYLE and TYPE (Membrane or Heavy Duty)
- M** = 3 X 4 Matrix

CABLE LENGTH

The default cable length for Indala modules is 18 inches (46 cm). No entry is needed for an 18 inch cable. For Reader Cores an optional 10 ft (3 m) pigtail is available through the HID European, America and Asia Pacific offices. Requires a minimum 2,500 unit order quantity. Place /L in the 7th position for ordering the 10 ft (3 m) cable. **Note:** Do not order Reader Packages with the 10 ft (3 m) cable. When ordering the 10 ft (3 m) cable, bezels must be ordered separately. Call Customer Service for assistance.

FlexPass Accessories

Part Number	Description
21211-001	Enclosure Base, ASR-620
21212-001	Enclosure Cover, ASR-620++
FPZ1231A	Bezel Wave Style, Midrange Type, Black
FPZ1234A	Bezel Wave Style, Midrange Type, Blue
FPZ1511A	Bezel Wave Style, Slim Type, Black
FPZ1514A	Bezel Wave Style, Slim Type, Blue
FPZ1521A	Bezel Wave Style, Wallswitch Type, Black
FPZ1524A	Bezel Wave Style, Wallswitch Type, Blue
FPZ2511A	Bezel Curve Style, Slim Type, Black
FPZ2521A	Bezel Curve Style, Wallswitch Type, Black
FPZ3231A	Bezel Arch Style, Midrange Type, Black
FPZ3235A	Bezel Arch Style, Midrange Type, Grey
FPZ3236A	Bezel Arch Style, Midrange Type, White
FPZ3237A	Bezel Arch Style, Midrange Type, Beige
FPZ3511A	Bezel Arch Style, Slim Type, Black
FPZ3515A	Bezel Arch Style, Slim Type, Grey
FPZ3516A	Bezel Arch Style, Slim Type, White
FPZ3517A	Bezel Arch Style, Slim Type, Beige
FPZ3521A	Bezel Arch Style, Wallswitch Type, Black
FPZ3521H	Bezel Arch Style, Wallswitch Type, Black (HID)
FPZ3525A	Bezel Arch Style, Wallswitch Type, Grey
FPZ3526A	Bezel Arch Style, Wallswitch Type, White
FPZ3527A	Bezel Arch Style, Wallswitch Type, Beige
FPZ3527H	Bezel Arch Style, Wallswitch Type, Beige (HID)
FPZ4511A	Bezel Linear Style, Slim Type, Black
FPZ-4511A	Bezel Linear Slim Black Cover
FPZ4517A	Bezel Linear Style, Slim Type, Beige
FPZ4521A	Bezel Linear Style, Wallswitch Type, Black
FPZ4525A	Bezel Linear Style, Wallswitch Type, Grey
FPZ4526A	Bezel Linear Style, Wallswitch Type, White
FPZ4527A	Bezel Linear Style, Wallswitch Type, Beige
FPZ4551A	Bezel Linear Style, Slim Type, Black
FPZC1511H	Bezel, HID, Wave, Slim, 5, Black
FPZC1514H	Bezel, HID, Wave, Slim, 5, Blue
FPZC1524H	Bezel, HID, Wave, Wallswitch, 5, Blue
KIT-AFP1000-2005	AFP1000-2005, Upgrade
KIT-AFP1000-2005-A/R	AFP1000 Advance Replacement
XXZ112	Bezel, Wave, Slim, 5, Blue
XXZ122	Bezel, Wave, W/S, 5, Blue
XXZ321	Bezel, Arch, W/S, Black
SH-003	Indala Credentials Special Handling, New marking label codes

Notes:

- To ensure security of the format and cards, a Software License Agreement must be signed by the final user of the 3175BNN00, 3012AKN00, 3012ANS00, and be on file at HID prior to shipment.
- Developer's Resource CD includes: Serial Protocol Documentation and Developer's Test Program to assist in developing custom MIFARE software applications.
- Demo CD Includes: MIFARE Documentation and Sample Application Program.

HID MOBILE ACCESS

What Is HID Mobile Access?

HID Mobile Access complements your existing access control solution. Besides using cards or fobs, staff can now securely access the facility using their Android or iOS mobile device.

HID Mobile Access, powered by Seos, consists of the following components:

- HID Mobile Access Portal: A management portal that allows you to manage users and securely issue or revoke Mobile IDs to users' handsets. The portal is available as a hosted service.
- HID Mobile Access Application: This app is available for Android and iOS devices, free of charge.
- Mobile IDs: The Mobile IDs with integrated Seos technology are for management of trusted identities. See details on ordering below.
- iCLASS SE mobile-enabled Readers. See details on ordering below.

Onboarding and Ordering

The following steps are required to complete onboarding, to be able to order products for use with HID Mobile Access:

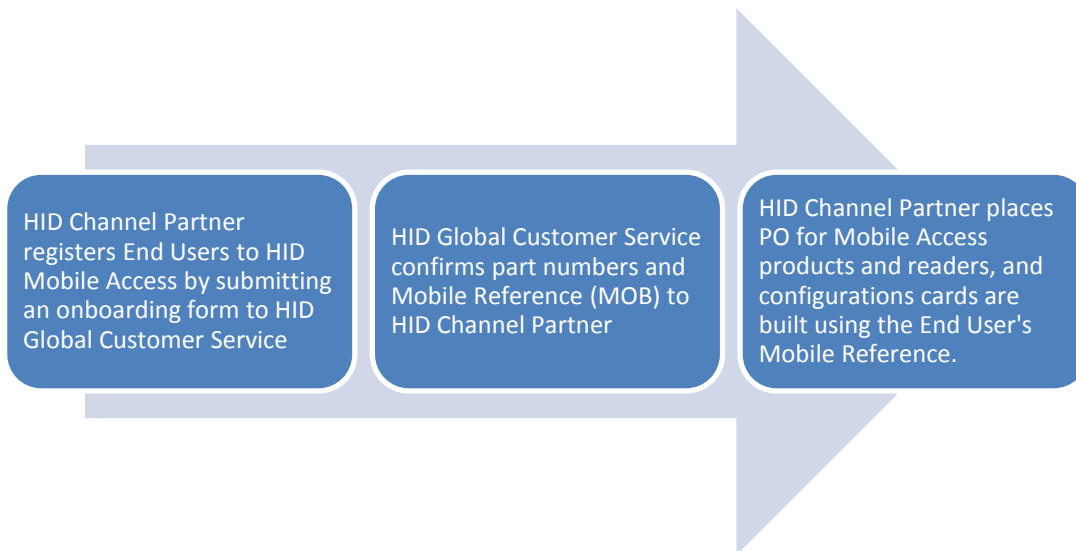

To get more information on how to register for HID Mobile Access please contact your HID Global Sales Representative or HID Global Customer Service.

Contact information is available at: <http://www.hidglobal.com/customer-service>.

Solution Component Overview

Component	Details	Supplemental Information Needed for Order
Mobile Reference (MOB)	Mobile References are specific to a given organization and are confirmed during account setup. The correct Mobile Reference must be supplied when ordering HID Mobile Access Readers and configuration cards.	
Mobile IDs	Mobile IDs are virtual credentials electronically delivered to the Organizations Mobile Access Portal account. Part number: CRD633ZZ-xxxxx Custom Mobile ID, xxxxx specific to organization and issued at time of part number creation.	xxxxx specific to organization
Mobile-Ready Readers	See iCLASS SE Readers . Mobile-Ready readers are prepared to support HID Mobile Access, but lack the personalized configuration to read an organization's specific Mobile IDs. These readers can be ordered at any time but will require field activation after the organization has completed registration for HID Mobile Access. To support a specific organization's Mobile IDs, these readers need to be personalized using a Mobile Key Card. Mobile-Ready readers can be ordered with NFC support only, or NFC and Bluetooth Smart support.	
Mobile-Enabled Readers	See iCLASS SE Readers . Mobile-Enabled readers are fully activated and personalized to support an organization's specific Mobile IDs. These readers can only be ordered after the organization has completed registration for HID Mobile Access and assigned a Mobile Reference (MOB) or HID Elite Reference (ICE). MOB or ICE will be required at time of order. Mobile-Enabled readers can be ordered with NFC support only, or NFC and Bluetooth Smart support.	Mobile Reference
Mobile Key Card	Configuration card used to personalize and activate a Mobile-Ready reader; converting it to a Mobile-Enabled reader. Part number: SEC9X-CRD-E-MKYD	Mobile Reference
Mobile Admin Card	Configuration card which enables the use of the Mobile Configuration App, used to adjust Bluetooth range settings on Mobile-Enabled Readers. Custom part number: SEC9X-CRD-MAD-xxxx xxxx specific to organization and issued at time of part number creation.	xxxx specific to organization

CREDENTIALS

Understanding HID Credentials

What should I know about security keysets?

iCLASS SE readers and iCLASS Seos / iCLASS SE credentials offer two keyset security schemes, HID Elite and Standard.

The **HID Elite Security Program** supports a unique keyset on a per site/company basis.

The keyset governs a variety of keys, including:

- Media (credential) keys for iCLASS SE, SIO-encoded iCLASS, MIFARE Classic (SIO) and MIFARE DESFire EV1 (SIO) credentials
- SIO authenticity and privacy keys (media independent)
- Configuration programming keys (for programming reader configuration, also media independent)

When utilizing HID's standard key set for the above keys, all standard keyed credentials work with all standard keyed readers. Additionally, any Standard Security configuration card configures a Standard Security reader (only accomplished during the first five (5) seconds after reader powers-up). Conversely, when utilizing the HID Elite program, only site/company specific HID Elite credentials and programming cards work with matching readers.

The **Standard Security Program** provides universal keysets that offer maximized compatibility by keying readers and cards with matching security for use in the general population. This allows for maximized compatibility because readers and cards are not keyed on a per site/company basis but rather all keyed the same. This offers the advantage to the integrator as a standard stock of readers and cards will interoperate for a variety of sites/companies, rather than needing different stocks of readers and cards for each individual site. iCLASS SE readers provide two Standard Security Keysets that offer compatibility with the following credentials:

Standard Security Keyset	Compatibility with these Credentials
Version 1	iCLASS Seos (+ Prox) iCLASS SE (+ Prox) iCLASS SR (+ Prox) iCLASS (+ Prox) MIFARE Classic (+ Prox) MIFARE DESFire EV1 (+ Prox)
Version 2	iCLASS Seos (+ Prox) iCLASS SE (+ Prox) MIFARE Classic (+ Prox) MIFARE DESFire EV1 (+ Prox)

How can I order HID Elite configured credentials?

- Direct customers of HID must be authorized to purchase components with HID Elite keys. If you are not authorized, you must have the key owner authorize you through the Authorization form. See <http://www.hidglobal.com/services/secure-identity/credential-programs/iclass-elite-and-se-elite>.
- Ensure the HID Elite flag is set in the part number (of readers, credentials and programming cards).
- All Purchase Orders for HID Elite components must be ordered with the HID Elite reference number (starts with ICE or MOB).

How can I migrate from my current credential technology?

- **iCLASS Existing Sites:** When deploying credentials to an existing site with standard iCLASS credentials and readers the following steps provide a guideline to a recommended path:
 1. Purchasing iCLASS Seos + iCLASS cards along with iCLASS SE Readers - Standard profile with Maximum compatibility credential support (supporting iCLASS cards), as this provides full interoperability with HID's latest credential and reader platform, as well as supporting installed iCLASS base.
 2. This provides options to upgrade security in the future without rip-and-replace of the newly purchased readers
 3. Once all readers on site are iCLASS SE the customer can begin ordering iCLASS Seos only cards.
 4. Once all cards in the population are iCLASS Seos, readers can be configured to support only iCLASS Seos cards.
- **125 kHz Existing Sites:** Deploying credentials to an existing 125 kHz site with HID Prox/Indala Proximity credentials and readers (HID, Indala, AWID, and EM4102), purchase multi-technology iCLASS Seos or iCLASS SE Credentials, along with multiCLASS SE Readers for full credential and reader interoperability, and a relaxed migration timeline.



What is the difference between iCLASS Seos, iCLASS SE and iCLASS credentials?

iCLASS Seos credentials deliver enhanced security, data confidentiality and stronger authentication for user data. Seos comprises a generic card edge (card command interface) to meet the growing demand for interoperability; a secure messaging protocol to protect data transmission. In addition, Seos provides an open software architecture that is portable to a range of mobile devices and microprocessors. The credential offers enhanced privacy protection by delivering data confidentiality and integrity between the smart card and the reader to prevent sensitive/personal data from being intercepted or cloned. iCLASS Seos credentials are only delivered with a single access control data payload, the SIO, and are **not** backwards compatible with iCLASS readers.

iCLASS SE credentials come with a single access control data payload, the SIO. iCLASS SE credentials are designed to work in an installation of iCLASS SE readers only and are **not** backwards compatible with iCLASS readers.

iCLASS credentials are offered either with or without an encoded SIO. For the SIO encoded option, this card will come with two access control data payloads: the SIO and iCLASS access control data payload. These credentials provide backward compatibility with currently deployed systems, maximizing compatibility. iCLASS credentials encoded with SIO should be purchased when the site needs legacy application support, or when the site plans to eventually migrate to SIO security. iCLASS credentials encoded with SIOs were previously marketed as iCLASS SR credentials.

iCLASS credentials are designed to work in an **existing** installation of standard iCLASS readers. iCLASS credentials are compatible with both iCLASS readers and iCLASS SE readers.*

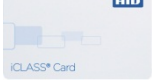
Credential Type		Works with iCLASS SE Readers*	Works with iCLASS Readers	Advantage
	iCLASS Seos	Yes	No	Best-in-class security and privacy protection, programmable card, portability, interoperability (standards based) and usability (read range).
	iCLASS SE	Yes	No	Increased Security
	iCLASS , SIO encoded (Previously called iCLASS SR)	Yes (reading SIO or standard iCLASS access control application)	Yes (Reading standard iCLASS access control application)	Increased Security when reading SIO, maximum compatibility - works with both iCLASS and iCLASS SE readers.
	iCLASS , without SIO encoding	Yes	Yes	

*Reader support depends on reader model and configuration selected.



Credentials Marking

The following external card designations are used on HID credentials.

Model Number	Description	External Card Designation
2000	iCLASS 2k	©HID iCLASS JH
2001/2002	iCLASS 16k	©HID iCLASS JH
2003/2004	iCLASS 32k	©HID iCLASS JH
2020	iCLASS 2k + Prox	©HID iCLASS Px JAH
2021/2022	iCLASS 16k + Prox	©HID iCLASS Px JAH
2023/2024	iCLASS 32k + Prox	©HID iCLASS Px JAH
2100	iCLASS 2k Composite	©HID iCLASS JH XT
2101/2102	iCLASS 8k Composite	©HID iCLASS JH XT
2103/2104	iCLASS 16k Composite	©HID iCLASS JH XT
2120	iCLASS 2k + Prox Composite	©HID iCLASS Px JAH XT
2121/2122	iCLASS 8k +Prox Composite	©HID iCLASS Px JAH XT
2123/2124	iCLASS 16k + Prox Composite	©HID iCLASS Px JAH XT
2320xM	iCLASS 2k + MIFARE Classic 1K	©HID iCLASS MF JBH
2321xN / 2322xN	iCLASS 16k + MIFARE Classic 4K	©HID iCLASS MF JCH
2323xN / 2324xN	iCLASS 32k + MIFARE Classic 4K	©HID iCLASS MF JCH
2321xK / 2322xK	iCLASS 16k + MIFARE DESFire EV1 8K	©HID iCLASS DF JDH
2323xK / 2324xK	iCLASS 32k + MIFARE DESFire EV1 8K	©HID iCLASS DF JDH
2420xM	iCLASS 2k + MIFARE Classic 1K Composite	©HID iCLASS MF JBH XT
2421xN / 2422xN	iCLASS 16k + MIFARE Classic 4K Composite	©HID iCLASS MF JCH XT
2423xN / 2424xN	iCLASS 32k + MIFARE Classic 4K Composite	©HID iCLASS MF JCH XT
2421xK / 2422xK	iCLASS 16k + MIFARE DESFire EV1 8K Composite	©HID iCLASS DF JDH XT
2423xK / 2424xK	iCLASS 32k + MIFARE DESFire EV1 8K Composite	©HID iCLASS DF JDH XT
2520xMP	iCLASS 2k + MIFARE Classic 1K + Prox	©HID iCLASS MF pX JBAH
2521xNP / 2522xNP	iCLASS 16k + MIFARE Classic 4K + Prox	©HID iCLASS MF pX JCAH
2523xNP / 2524xNP	iCLASS 32k + MIFARE Classic 4K + Prox	©HID iCLASS MF pX JCAH
2521xKP / 2522xKP	iCLASS 16k + MIFARE DESFire EV1 8K + Prox	©HID iCLASS DF pX JDAH
2523xKP / 2524xKP	iCLASS 32k + MIFARE DESFire Ev1 8K + Prox	©HID iCLASS DF pX JDAH
2620xMP	iCLASS 2k + MIFARE Classic 1K + Prox Composite	©HID iCLASS MF pX JBAH XT
2621xNP / 2622xNP	iCLASS 16k + MIFARE Classic 4K + Prox Composite	©HID iCLASS MF pX JCAH XT
2623xNP / 2624xNP	iCLASS 32k + MIFARE Classic 4K + Prox Composite	©HID iCLASS MF pX JCAH XT
3000	iCLASS SE 2k	©HID iCLASS JH SE
3003 / 3004	iCLASS SE 32k	©HID iCLASS JH SE
3050	iCLASS SE 2k Composite	©HID iCLASS JH SE XT
3053 / 3054	iCLASS SE 32k Composite	©HID iCLASS JH SE XT
3100	iCLASS SE 2k + Prox	©HID iCLASS JAH SE
3103 / 3104	iCLASS SE 32k + Prox	©HID iCLASS JAH SE
3150	iCLASS SE 2k + Prox	©HID iCLASS JAH SE XT
3153 / 3154	iCLASS SE 32k + Prox	©HID iCLASS JAH SE XT
3400	SIO-Enabled Technology for MIFARE 1K	©HID MIFARE BH SE
3406	SIO-Enabled Technology for MIFARE 4K	©HID MIFARE CH SE
3450	SIO-Enabled Technology for MIFARE 1K Composite	©HID MIFARE BH SE XT
3456	SIO-Enabled Technology for MIFARE 4K Composite	©HID MIFARE CH SE XT
3500	SIO-Enabled Technology for MIFARE 1K + Prox	©HID MIFARE BAH SE
3506	SIO-Enabled Technology for MIFARE 4K + Prox	©HID MIFARE CAH SE



Model Number	Description	External Card Designation
3550	SIO-Enabled Technology for MIFARE 1K + Prox Composite	©HID MIFARE BAH SE XT
3556	SIO-Enabled Technology for MIFARE 4K + Prox Composite	©HID MIFARE CAH SE XT
3700	SIO-Enabled Technology for MIFARE DESFire EV1 8K	©HID DESFire DH SE
3750	SIO-Enabled Technology for MIFARE DESFire EV1 8K Composite	©HID DESFire DH SE XT
3800	SIO-Enabled Technology for MIFARE DESFire EV1 8K + Prox	©HID DESFire DAH SE
3850	SIO-Enabled Technology for MIFARE DESFire EV1 8K + Prox Composite	©HID DESFire DAH SE XT
5005	iCLASS Seos 16K Composite	©HID iCLASS Seos JH XT
5006	iCLASS Seos 8K Composite	©HID iCLASS Seos JH XT
5105	iCLASS Seos 16K + Prox Composite	©HID iCLASS Seos JAH XT
5106	iCLASS Seos 8K + Prox Composite	©HID iCLASS Seos JAH XT
5206	iCLASS Seos 8K + iCLASS + Prox Composite	©HID iCLASS Seos Px JJAH XT
5226	iCLASS Seos 8K + iCLASS Composite	©HID iCLASS Seos Px JJAH XT
600	SIO-Enabled Technology for UHF Composite	©HID UHF GH XT
601	SIO-Enabled UHF+ iCLASS SE Composite	©HID UHF GCH XT
603	SIO-Enabled UHF+ MIFARE CLASSIC 4K	©HID UHF MF 1M4P XT

Announcement Regarding Credentials Marking

As a part of our commitment to continuous enhancements of world-class products and solutions, HID Global is transitioning to the most innovative card marking technology available.

Effective immediately, HID Global is moving from ink jet card marking to the new laser engraving card marking technology for all Genuine HID® cards, fobs and authentication tokens. This state-of-the-art laser engraving technology will result in a more appealing look and feel and reduce the ecological footprint of card production.

All relevant orders in the United States and Canada are affected immediately.

Key benefits:

- Marking quality and durability of the cards will be enhanced and more consistent
- New engraving technology reflects HID Global's commitment to sustainability by eliminating the use of solvents
- Improved Proof of Authenticity since engraved markings cannot be removed or modified.
- The enhanced design will be available at no additional charge. The laser-engraving surcharge for Genuine HID Proximity and Contactless Credentials will be removed in November.

Depending on the fulfillment center, customers may receive either inkjet or laser marked cards during the transition period beginning October 2014. All ID1 cards (Clamshell Cards included), key fobs (including Microtags, Keytags and Microprox) and authentication tokens will have the enhanced laser engraving design immediately.

Notes:

- The numbering scheme and part number for existing part numbers will not change. Please contact your sales representative to see the new design and get sample cards.
- Due to the 3D nature of laser engraved markings, printing over these markings is not recommended as it may impact print quality.
- For all relevant Credentials ordered and/or shipped out of North America, the laser-etched version supersedes all ink jet card part numbers.
- For further details on the printing areas, please contact HID Global.

Please contact HID Customer Service or Sales Representative if you have additional questions regarding this notice.

iCLASS Seos Credentials

Note: See *Understanding HID Credentials* on page 40 for guidance.

iCLASS Seos Card - 500

Increased security and interoperability cards for installation supporting iCLASS SE platform. All iCLASS Seos 8K cards are OTP enabled. *Ensure each required option has been checked with the appropriate choice to fulfill a completed order form.*

Base Model 500 Composite 40% Polyester / PVC*

iCLASS Seos Memory Size and Allocation (Select one option)

- 5 - 16K Bytes
- 6 - 8K Bytes⁶

Secure Identity Object[®] Programming (Select one option)

- P - Programmed with Security Identity Object (SIO)
- V - Unprogrammed, for use with iCLASS SE Encoder

Front Packaging (Select one option)

- G - Plain White with Gloss Finish
- C - Custom Artwork with Gloss Finish - Specify Custom Artwork Number¹

Back Packaging (Select one option)

- G - Plain White with Gloss Finish²
- C - Custom Artwork with Gloss Finish - Specify Custom Artwork Number¹
- 1 - Plain White with Gloss Finish with Magnetic Stripe²
- 3 - Custom Artwork with Gloss Finish with Magnetic Stripe - Specify Custom Artwork Number¹

Card Numbering³ (Select one option)

- M - Sequential Matching Encoded/Printed (Inkjetted)⁵
- N - No Printed Card Numbering
- S - Sequential Encoded/Sequential Non-Matching Printed (Inkjetted)⁵
- R - Random Encoded/Non-Matching Sequential Printed (Inkjetted)⁵
- A - Sequential Matching Encoded/Printed (Laser Engraved)
- B - Sequential Encoded/Sequential Non-Matching Printed (Laser Engraved)
- C - Random Encoded/Non-Matching Sequential Printed (Laser Engraved)

Slot Punch⁴ (Select one option)

- N - No Slot Punch

Packing (Optional)

- T - Packs of 10 (shrink wrap) in standard box

Option - Custom Artwork¹

- _____ (Specify Artwork Number - Refer to the Custom Artwork Forms for new artwork)

Enter your final card options from check boxes above. Example: 5005PGGNNT

Final Part Number	500							N		-	(Options #)
-------------------	-----	--	--	--	--	--	--	---	--	---	-------------

iCLASS Seos Card Programming Information

Format Number _____ (example: H10301) Bit Numbers _____ (example: 26 bit) Facility Code _____

Encoded Card # Start _____ Stop _____ Printed Card # Start _____ Stop _____

HID Elite ICE Number (if applicable) - _____ (Custom Format) Site Code _____ City Code _____ OEM Code _____

Special Instructions: _____

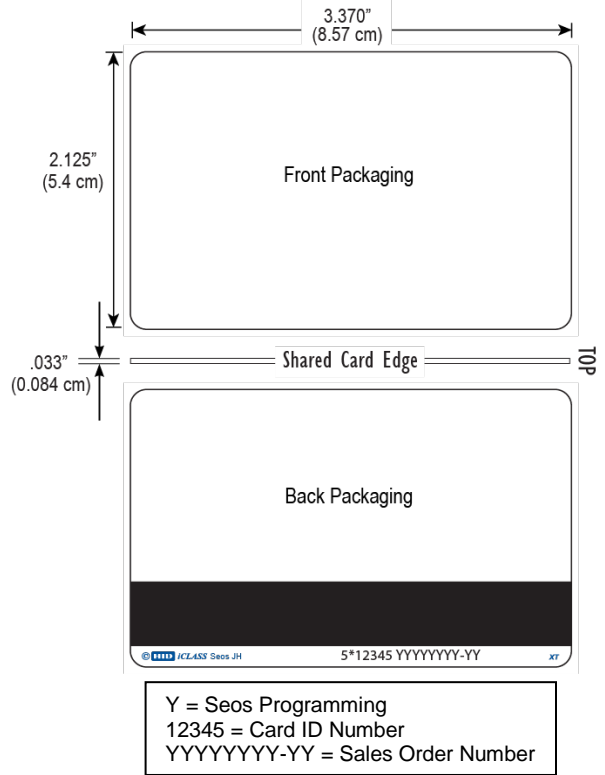

¹ For new artwork files, contact Customer Service for custom artwork number, lead-times, and cost.

² Cards ordered with plain white front and back packaging, or custom artwork, will still have a small HID logo and reference number printed in the lower left-hand corner.

³ The Printed card number is placed in the bottom right-hand corner on the back of the card.

⁴ Cards are not available with any slot punch option.

⁵ Please note that cards shipped within North America are always laser-engraved. Inkjetted option is not available for these cards.

⁶ Available with 7 byte static UID for ISO14443A UID migration and interoperability. This feature reduces privacy and is not recommended. Contact your local sales or pre-sales representative for details.



iCLASS Seos + iCLASS Card - 522

Migration solution from iCLASS to Seos in iCLASS SE platform. All iCLASS Seos 8K cards are OTP enabled. Ensure each required option has been checked with the appropriate choice to fulfill a completed order form.

Base Model 522 Composite 40% Polyester / PVC*

iCLASS Seos and Memory Size and Allocation

6 - 8K Bytes⁶

iCLASS Memory Size and Allocation (Select one option)

- 0 - iCLASS 2k Bits (256 Bytes) with 2 Application Areas
- 3 - CLASS 32k Bits (4K Bytes) Application areas 16k/2+16k/1
- 4 - CLASS 32k Bits (4K Bytes) Application areas 16k/16+16k/1

iCLASS Seos Programming (Select one option)

- P - Programmed with Security Identity Object (SIO)
- V - Unprogrammed, for use with iCLASS SE Encoder (Must be combined with C option below)

iCLASS Programming (Select one option)

- S - Programmed with Security Identity Object (SIO) and with standard iCLASS Access Control Application (recommended)
- P - Programmed with Security Identity Object (SIO)
- H - Programmed with standard iCLASS Access Control Application
- C - Unprogrammed, for use with iCLASS SE Encoder (Must be combined with V option above)

Front Packaging (Select one option)

- G - Plain White with Gloss Finish
- C - Custom Artwork with Gloss Finish - Specify Custom Artwork Number¹

Back Packaging (Select one option)

- G - Plain White with Gloss Finish²
- C - Custom Artwork with Gloss Finish - Specify Custom Artwork Number¹
- 1 - Plain White with Gloss Finish with Magnetic Stripe²
- 3 - Custom Artwork with Gloss Finish with Magnetic Stripe - Specify Custom Artwork Number¹

iCLASS Seos Card Numbering³ (Select one option)

- N - No Printed Card Numbering
- A - Sequential Matching Encoded/Printed (Laser Engraved)⁵
- B - Sequential Encoded/Sequential Non-Matching Printed (Laser Engraved)⁵
- C - Random Encoded/Non-Matching Sequential Printed (Laser Engraved)⁵

iCLASS Card Numbering³ (Select one option)

- N - No Printed Card Numbering
- A - Sequential Matching Encoded/Printed (Laser Engraved)⁵
- B - Sequential Encoded/Sequential Non-Matching Printed (Laser Engraved)⁵
- C - Random Encoded/Non-Matching Sequential Printed (Laser Engraved)⁵

Slot Punch⁴

N - No Slot Punch

Option - Custom Artwork¹

_____ (Specify Artwork Number - Refer to the Custom Artwork Forms for new artwork)

Enter your final card options from check boxes above. Example: 52263PSGGAAN

Final Part Number	522	6									N	-	(Options #)
-------------------	-----	---	--	--	--	--	--	--	--	--	---	---	-------------

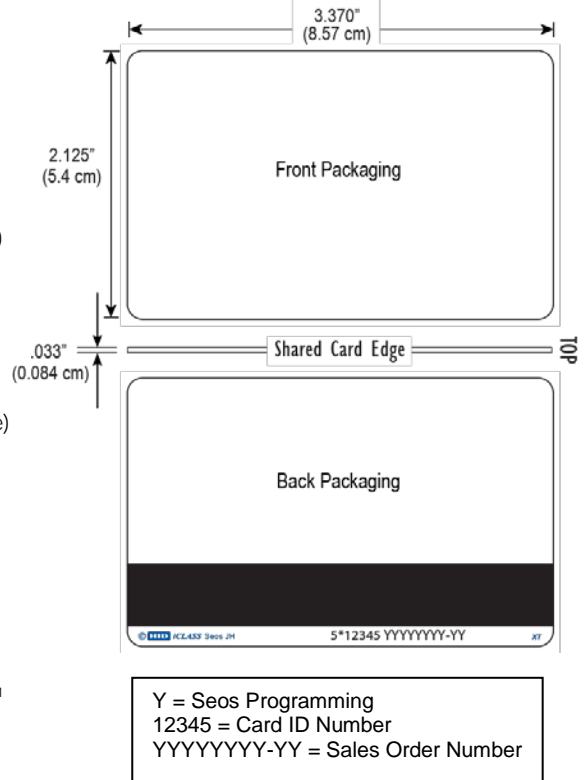



iCLASS Seos Card Programming Information

Format Number ____ (example: H10301) Bit Numbers ____ (example: 26 bit) Facility Code ____
Encoded Card # Start ____ Stop ____ Printed Card # Start ____ Stop ____
HID Elite ICE Number (if applicable) - ____ (Custom Format) Site Code ____ City Code ____ OEM Code ____
Special Instructions: ____

iCLASS Card Programming Information

Format Number ____ (example: H10301) Bit Numbers ____ (example: 26 bit) Facility Code ____
Encoded Card # Start ____ Stop ____ Printed Card # Start ____ Stop ____
HID Elite ICE Number (if applicable) - ____ (Custom Format) Site Code ____ City Code ____ OEM Code ____
Special Instructions: ____

¹ For new artwork files, contact Customer Service for custom artwork number, lead-times, and cost.

² Cards ordered with plain white front and back packaging, or custom artwork, will still have a small HID logo  and reference number printed in the lower left-hand corner

³ The Printed card number is placed in the bottom right-hand corner on the back of the card.

⁴ Cards are not available with any slot punch option.

⁵ Inkjetted option is not available for these cards.

⁶ Available with 7 byte static UID for ISO14443A UID migration and interoperability. This feature reduces privacy and is not recommended. Contact your local sales or pre-sales representative for details.

* The composite construction is recommended for all cards with over-laminate applied. Consult with the printer manufacturer prior to ordering.



iCLASS Seos + Prox Card - 510

Migration solution from proximity to high security for support in iCLASS SE platform. All iCLASS Seos 8K cards are OTP enabled. Ensure each required option has been checked with the appropriate choice to fulfill a completed order form.

Base Model **510 Composite 40% Polyester / PVC***

iCLASS Seos Memory Size and Allocation (Select one option)

- 5 - 16K Bytes
- 6 - 8K Bytes⁶

Programming (Select one option)

- P - Programmed with Security Identity Object (SIO), Prox non programmed
- R - Both interfaces programmed: iCLASS Seos with Security Identity Object (SIO), Prox programmed with HID format
- V - Unprogrammed, for use with iCLASS SE Encoder

Front Packaging (Select one option)

- G - Plain White with Gloss Finish
- C - Custom Artwork with Gloss Finish - Specify Custom Artwork Number¹

Back Packaging (Select one option)

- G - Plain White with Gloss Finish²
- C - Custom Artwork with Gloss Finish - Specify Custom Artwork Number¹
- 1 - Plain White with Gloss Finish with Magnetic Stripe²
- 3 - Custom Artwork with Gloss Finish with Magnetic Stripe - Specify Custom Artwork Number¹

iCLASS Seos Card Numbering³ (Select one option)

- M - Sequential Matching Encoded/Printed (Inkjetted)⁵
- N - No Printed Card Numbering
- S - Sequential Encoded/Sequential Non-Matching Printed (Inkjetted)⁵
- R - Random Encoded/Non-Matching Sequential Printed (Inkjetted)⁵
- A - Sequential Matching Encoded/Printed (Laser Engraved)
- B - Sequential Encoded/Sequential Non-Matching Printed (Laser Engraved)
- C - Random Encoded/Non-Matching Sequential Printed (Laser Engraved)

Slot Punch⁴

- N - No Slot Punch

125 kHz Card Numbering³ (Select one option)

- M - Sequential Matching Encoded/Printed (Inkjetted)⁵
- N - No Printed Card Numbering
- S - Sequential Encoded/Sequential Non-Matching Printed (Inkjetted)⁵
- R - Random Encoded/Non-Matching Sequential Printed (Inkjetted)⁵

Option - Custom Artwork¹

- _____ (Specify Artwork Number - Refer to the Custom Artwork Forms for new artwork)

Enter your final card options from check boxes above. Example: 5105PGGNNN

Final Part Number	510						N		-	(Options #)
--------------------------	------------	--	--	--	--	--	----------	--	---	--------------------

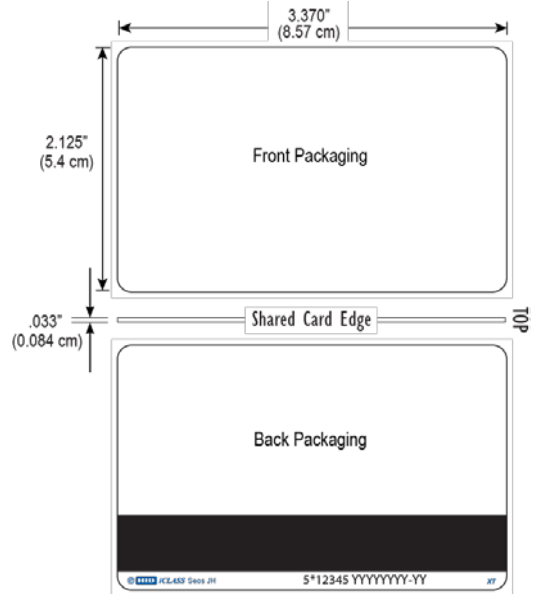

Y = Seos Programming
 12345 = Card ID Number
 YYYYYYYY-YY = Sales Order Number

- A - Sequential Matching Encoded/Printed (Laser Engraved)
- B - Sequential Encoded/Sequential Non-Matching Printed (Laser Engraved)
- C - Random Encoded/Non-Matching Sequential Printed (Laser Engraved)

iCLASS Seos Card Programming Information

Format Number ____ (example: H10301) Bit Numbers ____ (example: 26 bit) Facility Code ____
 Encoded Card # Start ____ Stop ____ Printed Card # Start ____ Stop ____
 HID Elite ICE Number (if applicable) - ____ (Custom Format) Site Code ____ City Code ____ OEM Code ____
 Special Instructions: _____

125 kHz Card Programming Information

Format Number ____ (example: H10301) Bit Numbers ____ (example: 26 bit) Facility Code ____
 Encoded Card # Start ____ Stop ____ Printed Card # Start ____ Stop ____
 HID Elite ICE Number (if applicable) - ____ (Custom Format) Site Code ____ City Code ____ OEM Code ____
 Special Instructions: _____

¹ For new artwork files, contact Customer Service for custom artwork number, lead-times, and cost.
² Cards ordered with plain white front and back packaging, or custom artwork, will still have a small HID logo and reference number printed in the lower left-hand corner.
³ The Printed card number is placed in the bottom right-hand corner on the back of the card.
⁴ Cards are not available with any slot punch option.
⁵ Please note that cards shipped within North America are always laser-engraved. Inkjetted option is not available for these cards.
⁶ Available with 7 byte static UID for ISO14443A UID migration and interoperability. This feature reduces privacy and is not recommended. Contact your local sales or pre-sales representative for details.
 * The composite construction is recommended for all cards with over-laminate applied. Consult with the printer manufacturer prior to ordering.

iCLASS Seos + iCLASS + Prox Card - 520

Migration solution from proximity and/or iCLASS to high security for support in iCLASS SE platform. All iCLASS Seos 8K cards are OTP enabled. Ensure each required option has been checked with the appropriate choice to fulfill a completed order form.

Base Model 520 Composite 40% Polyester / PVC*

iCLASS Seos Memory Size and Allocation

6 - iCLASS Seos 8K Bytes⁶

iCLASS Memory Size and Allocation

- 0 - iCLASS 2k Bits (256 Bytes) with 2 Application Areas
- 3 - CLASS 32k Bits (4K Bytes) Application areas 16k/2+16k/1
- 4 - CLASS 32k Bits (4K Bytes) Application areas 16k/16+16k/1

iCLASS Seos Programming (Select one option)

- P - Programmed with Security Identity Object (SIO)
- V - Unprogrammed, for use with iCLASS SE Encoder (Must be combined with C option below)

iCLASS Programming (Select one option)

- S - Programmed with Security Identity Object (SIO) and with standard iCLASS Access Control Application (recommended)
- P - Programmed with Security Identity Object (SIO)
- H - Programmed with standard iCLASS Access Control Application
- C - Unprogrammed, for use with iCLASS SE Encoder (Must be combined with V option above)

Prox Programming (Select one option)

- P - Prox programmed
- N - Prox non programmed

Front Packaging (Select one option)

- G - Plain White with Gloss Finish
- C - Custom Artwork with Gloss Finish - Specify Custom Artwork Number¹

Back Packaging (Select one option)

- G - Plain White with Gloss Finish²
- C - Custom Artwork with Gloss Finish - Specify Custom Artwork Number¹
- 1 - Plain White with Gloss Finish with Magnetic Stripe²
- 3 - Custom Artwork with Gloss Finish with Magnetic Stripe - Specify Custom Artwork Number¹

iCLASS Seos Card Numbering³ (Select one option)

- N - No Printed Card Numbering
- A - Sequential Matching Encoded/Printed (Laser Engraved)⁴
- B - Sequential Encoded/Sequential Non-Matching Printed (Laser Engraved)⁴
- C - Random Encoded/Non-Matching Sequential Printed (Laser Engraved)⁴

iCLASS Card Numbering³ (Select one option)

- N - No Printed Card Numbering
- A - Sequential Matching Encoded/Printed (Laser Engraved)⁴
- B - Sequential Encoded/Sequential Non-Matching Printed (Laser Engraved)⁴
- C - Random Encoded/Non-Matching Sequential Printed (Laser Engraved)⁴

Prox Card Numbering³ (Select one option)

- N - No Printed Card Numbering
- A - Sequential Matching Encoded/Printed (Laser Engraved)⁴
- B - Sequential Encoded/Sequential Non-Matching Printed (Laser Engraved)⁴
- C - Random Encoded/Non-Matching Sequential Printed (Laser Engraved)⁴

Slot Punch⁵

N - No Slot Punch

Option - Custom Artwork¹

_____ (Specify Artwork Number - Refer to the Custom Artwork Forms for new artwork)

Enter your final card options from check boxes above. Example: 52063PSPGGAAAN

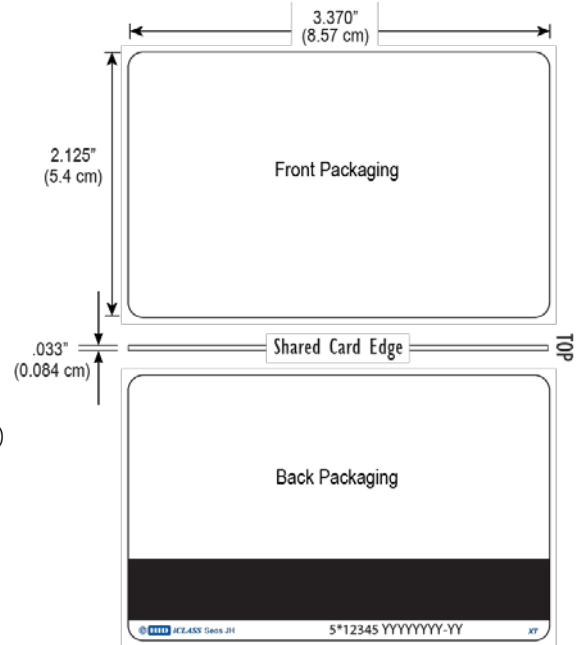

Y = Seos Programming
 12345 = Card ID Number
 YYYYYYYY-YY = Sales Order Number

Final Part Number	520	6													N	-	(Options #)
--------------------------	------------	----------	--	--	--	--	--	--	--	--	--	--	--	--	----------	----------	--------------------



iCLASS Seos Card Programming Information

Format Number ____ (example: H10301) Bit Numbers ____ (example: 26 bit) Facility Code ____
 Encoded Card # Start ____ Stop ____ Printed Card # Start ____ Stop ____
 HID Elite ICE Number (if applicable) - ____ (Custom Format) Site Code ____ City Code ____ OEM Code ____
 Special Instructions: ____

iCLASS Card Programming Information

Format Number ____ (example: H10301) Bit Numbers ____ (example: 26 bit) Facility Code ____
 Encoded Card # Start ____ Stop ____ Printed Card # Start ____ Stop ____
 HID Elite ICE Number (if applicable) - ____ (Custom Format) Site Code ____ City Code ____ OEM Code ____
 Special Instructions: ____

125 kHz Card Programming Information

Format Number ____ (example: H10301) Bit Numbers ____ (example: 26 bit) Facility Code ____
 Encoded Card # Start ____ Stop ____ Printed Card # Start ____ Stop ____
 HID Elite ICE Number (if applicable) - ____ (Custom Format) Site Code ____ City Code ____ OEM Code ____
 Special Instructions: ____

- ¹ For new artwork files, contact Customer Service for custom artwork number, lead-times, and cost.
- ² Cards ordered with plain white front and back packaging, or custom artwork, will still have a small HID logo and reference number printed in the lower left-hand corner and a slot punch target printed on the back of the card.
- ³ The Printed card number is placed in the bottom right-hand corner on the back of the card.
- ⁴ Inkjetted option is not available for these cards.
- ⁵ Cards are not available with any slot punch option.
- ⁶ Available with 7 byte static UID for ISO14443A UID migration and interoperability. This feature reduces privacy and is not recommended. Contact your local sales or pre-sales representative for details.
- * The composite construction is recommended for all cards with over-laminate applied. Consult with the printer manufacturer prior to ordering.

iCLASS SE Credentials

iCLASS SE Card - 300 / 305

Added security into installations that do not contain standard iCLASS readers, these cards are not available with iCLASS programming. Ensure each required option has been checked with the appropriate choice to fulfill a completed order form.

Base Model 300 Standard PVC 305 Composite 40% Polyester / PVC*

iCLASS Memory Size and Allocation (Select one option)

- 0 - 2k Bits (256 Bytes) with 2 Application Areas
- 3 - 32k Bits (4K Bytes) Application areas 16k/2+16k/1
- 4 - 32k Bits (4K Bytes) Application areas 16k/16+16k/1

Secure Identity Object Programming

- P - Programmed with Security Identity Object (SIO)
- V - Unprogrammed, for use with iCLASS SE Encoder

Front Packaging (Select one option)

- G - Plain White with Gloss Finish
- C - Custom Artwork with Gloss Finish - Specify Custom Artwork Number¹

Back Packaging (Select one option)

- G - Plain White with Gloss Finish²
- C - Custom Artwork with Gloss Finish - Specify Custom Artwork Number¹
- 1 - Plain White with Gloss Finish with Magnetic Stripe²
- 3 - Custom Artwork with Gloss Finish with Magnetic Stripe - Specify Custom Artwork Number¹

Card Numbering³ (Select one option)

- M - Sequential Matching Encoded/Printed (Inkjetted)⁷
- N - No Printed Card Numbering
- S - Sequential Encoded/Sequential Non-Matching Printed (Inkjetted)⁷
- R - Random Encoded/Non-Matching Sequential Printed (Inkjetted)⁷
- A - Sequential Matching Encoded/Printed (Laser Engraved)⁴
- B - Sequential Encoded/Sequential Non-Matching Printed (Laser Engraved)⁴
- C - Random Encoded/Non-Matching Sequential Printed (Laser Engraved)⁴

Slot Punch⁵ (Select one option)

- N - No Slot Punch. This card can be slotted vertically, Printed Vertical Slot Indicators⁶
- B - No Slot Punch. This card can be slotted horizontally, Printed Horizontal Slot Indicators⁶
- V - Vertical Slot Punch
- H - Horizontal Slot Punch⁶

Option - Custom Artwork¹

- _____ (Specify Artwork Number - Refer to the Custom Artwork Forms for new artwork)

Enter your final card options from check boxes above. Example: 3000PGGNN

Final Part Number										-	(Options #)
-------------------	--	--	--	--	--	--	--	--	--	---	-------------

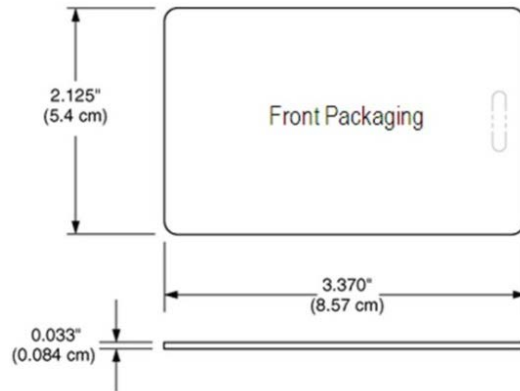

Y = iCLASS Programming
 12345 = Card ID Number
 YYYYYYYY-YY = Sales Order Number

iCLASS Card Programming Information

Format Number _____ (example: H10301) Bit Numbers _____ (example: 26 bit) Facility Code _____
 Encoded Card # Start _____ Stop _____ Printed Card # Start _____ Stop _____
 HID Elite ICE Number (if applicable) - _____ (Custom Format) Site Code _____ City Code _____ OEM Code _____
 Special Instructions: _____

¹ For new artwork files, contact Customer Service for custom artwork number, lead-times, and cost.
² Cards ordered with plain white front and back packaging, or custom artwork, will still have a small HID logo and reference number printed in the lower left-hand corner and a slot punch target printed on the back of the card.
³ The Printed card number is placed in the bottom right-hand corner on the back of the card.
⁴ For Laser Engraved Printed numbers, consult factory for lead times and cost.
⁵ Cards are provided with an optional slot punch at no additional charge. Some video imaging printers cannot accommodate pre-slot punched cards.
⁶ The ability to add a horizontal slot punch requires a different iCLASS antenna design. Users can expect a read range reduction of approximately 20% if they order options B or H for the Slot Punch.
⁷ Please note that cards shipped within North America are always laser-engraved. Inkjetted option is not available for these cards.
 * The composite construction is recommended for all cards with over-laminate applied. Consult with the printer manufacturer prior to ordering.



iCLASS SE + Prox Card - 310 / 315

Maximized compatibility with added security into installations that contain standard Prox credentials. These cards are not available with iCLASS programming.

Ensure each required option has been checked with the appropriate choice to fulfill a completed order form.

Base Model 310 Standard PVC 315 Composite 40% Polyester / PVC*

iCLASS Memory Size and Allocation (Select one option)

- 0 - 2k Bits (256 Bytes) with 2 Application Areas
- 3 - 32k Bits (4K Bytes) Application areas 16k/2+16k/1
- 4 - 32k Bits (4K Bytes) Application areas 16k/16+16k/1

Secure Identity Object Programming (Select one option)

- P - Programmed with Security Identity Object (SIO), Prox non programmed
- R - Both interfaces programmed: iCLASS with Security Identity Object (SIO), Prox programmed with HID format

Front Packaging (Select one option)

- G - Plain White with Gloss Finish
- C - Custom Artwork with Gloss Finish - Specify Custom Artwork Number¹

Back Packaging (Select one option)

- G - Plain White with Gloss Finish²
- C - Custom Artwork with Gloss Finish - Specify Custom Artwork Number¹
- 1 - Plain White with Gloss Finish with Magnetic Stripe²
- 3 - Custom Artwork with Gloss Finish with Magnetic Stripe - Specify Custom Artwork Number¹

13.56 MHz iCLASS Card Numbering³ (Select one option)

- M - Sequential Matching Encoded/Printed (Inkjetted)⁷
- N - No Printed Card Numbering
- S - Sequential Encoded/Sequential Non-Matching Printed (Inkjetted)⁷
- R - Random Encoded/Non-Matching Sequential Printed (Inkjetted)⁷
- A - Sequential Matching Encoded/Printed (Laser Engraved)⁴
- B - Sequential Encoded/Sequential Non-Matching Printed (Laser Engraved)⁴
- C - Random Encoded/Non-Matching Sequential Printed (Laser Engraved)⁴

Slot Punch⁵ (Select one option)

- N - No Slot Punch. This card can be slotted vertically, Printed Vertical Slot Indicators
- V - Vertical Slot Punch

125 kHz Card Numbering³ (Select one option)

- M - Sequential Matching Encoded/Printed (Inkjetted)⁶
- N - No Printed Card Numbering
- S - Sequential Encoded/Sequential Non-Matching Printed (Inkjetted)⁶
- R - Random Encoded/Non-Matching Sequential Printed (Inkjetted)⁶
- A - Sequential Matching Encoded/Printed (Laser Engraved)⁴
- B - Sequential Encoded/Sequential Non-Matching Printed (Laser Engraved)⁴
- C - Random Encoded/Non-Matching Sequential Printed (Laser Engraved)⁴

Option - Custom Artwork¹

_____ (Specify Artwork Number - Refer to the Custom Artwork Forms for new artwork)

Enter your final card options from check boxes above. Example: 3100PGGNNN

Final Part Number										-	(Options #)
--------------------------	--	--	--	--	--	--	--	--	--	---	--------------------

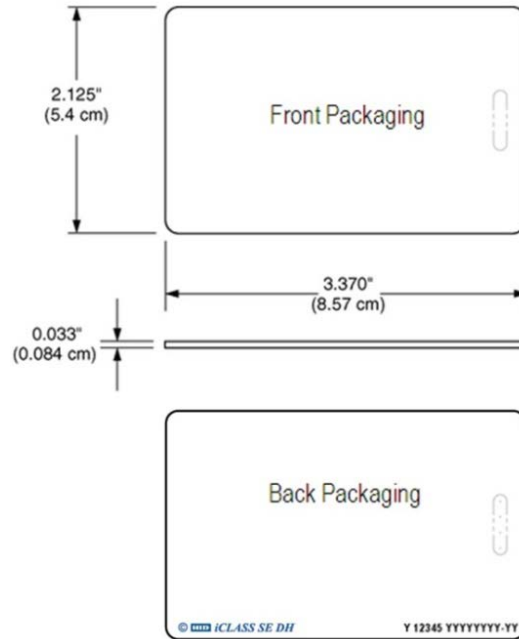

Y = iCLASS Programming
 12345 = Card ID Number
 YYYYYYYY-YY = Sales Order Number

iCLASS Card Programming Information

Format Number ____ (example: H10301) Bit Numbers ____ (example: 26 bit) Facility Code ____
 Encoded Card # Start ____ Stop ____ Printed Card # Start ____ Stop ____
 HID Elite ICE Number (if applicable) - ____ (Custom Format) Site Code ____ City Code ____ OEM Code ____
 Special Instructions: ____



125 kHz Card Programming Information

Format Number _____ (example: H10301) Bit Numbers _____ (example: 26 bit) Facility Code _____

Encoded Card # Start _____ Stop _____ Printed Card # Start _____ Stop _____

HID Elite ICE Number (if applicable) - _____ (Custom Format) Site Code _____ City Code _____ OEM Code _____

Special Instructions: _____

¹ For new artwork files, contact Customer Service for custom artwork number, lead-times, and cost.

² Cards ordered with plain white front and back packaging, or custom artwork, will still have a small HID logo  and reference number printed in the lower left-hand corner and a slot punch target printed on the back of the card.

³ The Printed card number is placed in the bottom right-hand corner on the back of the card.

⁴ For Laser Engraved Printed numbers, consult factory for lead times and cost.

⁵ Cards are provided with an optional slot punch at no additional charge. Some video imaging printers cannot accommodate pre-slot punched cards.

⁶ Please note that cards shipped within North America are always laser-engraved. Inkjetted option is not available for these cards.

* The composite construction is recommended for all cards with over-laminate applied. Consult with the printer manufacturer prior to ordering.



iCLASS SE Key - 325

The iCLASS SE contactless smart Key offers read/write capability while leveraging Security Identity Object for increased security. Attach to a key ring or badge clip for convenient use. The iCLASS SE key is not available with iCLASS programming.

Ensure each required option has been checked with the appropriate choice to fulfill a completed order form.

325 Base Model

iCLASS Memory Size and Allocation (Select one option)

- 0 - 2k Bits (256 Bytes) with 2 Application Areas
- 3 - 32k Bits (4K Bytes) Application areas 16k/2+16k/1
- 4 - 32k Bits (4K Bytes) Application areas 16k/16+16k/1

Secure Identity Object Programming (Select one option)

- P - Programmed with Security identity Object (SIO)
- V - Unprogrammed, for use with iCLASS SE Encoder

Front Packaging

- N - iCLASS Key II - Black with blue insert. Includes HID Standard Artwork

Back Packaging

- N - None

Key Numbering

- M - Sequential Matching Encoded/Printed (Inkjetted)⁴
- N - No Printed Key Numbering
- S - Sequential Encoded/Sequential Non-Matching Printed (Inkjetted)⁴
- R - Random Encoded/Non-Matching Sequential Printed (Inkjetted)⁴
- A - Sequential Matching Encoded/Printed (Engraved)²
- B - Sequential Encoded/Sequential Non-Matching Printed (Engraved)²
- C - Random Encoded/Non-Matching Sequential Printed (Engraved)²

Additional Options³

- N - None

Enter your final card options from the above selections. Example: 3250PNNMN

Final Part Number	325			N	N		N
--------------------------	------------	--	--	----------	----------	--	----------

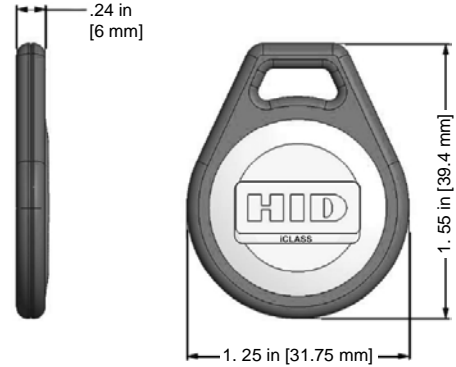

Shown - Front Packaging Option N

iCLASS Key Programming Information

Format Number ____ (example: H10301) Bit Numbers ____ (example: 26 bit) Facility Code ____

Encoded Card # Start ____ Stop ____ Printed Card # Start ____ Stop ____

HID Elite ICE Number (if applicable) - ____ (Custom Format) Site Code ____ City Code ____ OEM Code ____

Special Instructions: ____

¹ The Printed key number is placed on the back of the key.

² For Laser Engraved Printed numbers, consult factory for lead times and cost.

³ Key Ring sold separately (Part Number: 57-0001-02).

⁴ Please note that cards shipped within North America are always laser-engraved. Inkjetted option is not available for these cards.

iCLASS SE Tag - 330

The iCLASS SE contactless smart Tag offers read/write capability while leveraging Security Identity Object for increased security. iCLASS SE enable existing credentials or non-metallic devices such as cell phones or PDAs by adhering the iCLASS Tag. The iCLASS SE Tag is not available with iCLASS programming.

Ensure each required option has been checked with the appropriate choice to fulfill a completed order form.

330 Base Model

iCLASS Memory Size and Allocation (Select one option)

- 0 - 2k Bits (256 Bytes) with 2 Application Areas
- 3 - 32k Bits (4K Bytes) Application areas 16k/2+16k/1
- 4 - 32k Bits (4K Bytes) Application areas 16k/16+16k/1

Secure Identity Object Programming (Select one option)

- P - Programmed with Secure Identity Object (SIO).
- V - Unprogrammed, for use with iCLASS SE Encoder

Front Packaging (Select one option)

- K - Black with HID Standard Artwork
- C - Custom Artwork - Specify Custom Artwork Number²

Back Packaging

- S - Adhesive Backing

Tag Numbering¹ (Select one option)

- M - Sequential Matching Encoded/Printed (Inkjetted)⁴
- N - No Printed Tag Numbering
- S - Sequential Encoded/Sequential Non-Matching Printed (Inkjetted)⁴
- R - Random Encoded/Non-Matching Sequential Printed (Inkjetted)⁴

Slot Punch

- N - None

Option - Custom Artwork¹

_____ (Specify Artwork Number - Refer to the Custom Artwork Forms for new artwork)

Enter your final Tag options from check boxes above. Example: 3302PSSNN

Final Part Number	330				S		N	-	(Options #)
--------------------------	------------	--	--	--	----------	--	----------	----------	--------------------

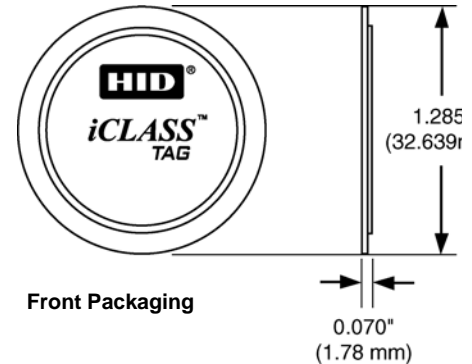

iCLASS Tag Programming Information

Format Number _____ (example: H10301) Bit Numbers _____ (example: 26 bit) Facility Code _____
 Encoded Card # Start _____ Stop _____ Printed Card # Start _____ Stop _____
 HID Elite ICE Number (if applicable) - _____ (Custom Format) Site Code _____ City Code _____ OEM Code _____
 Special Instructions: _____

¹ The Printed tag number is placed on the back of the tag.
² For new artwork files, contact Customer Service for custom artwork number, lead-times, minimum order quantities, and cost.
³ The iCLASS Tag is not for use on cards that use full insertion or tractor feed type readers.
⁴ Please note that cards shipped within North America are always laser-engraved. Inkjetted option is not available for these cards.

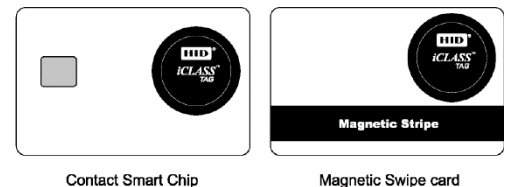

Do not adhere to metal surfaces. Metal shields the RF, making the tag inoperable. Due to variations in cards and reading devices, HID does not claim that the iCLASS Tag will work in every situation. Functional and non-functional iCLASS Tags are available for compatibility testing with existing credential and reader technologies. Compatibility should be confirmed prior to ordering.



iCLASS SE Clamshell Card - 335

Added security into installations that do not contain standard iCLASS readers, these cards are not available with iCLASS programming. Ensure each required option has been checked with the appropriate choice to fulfill a completed order form.

335 Base Model

imageiCLASS Memory Size and Allocation (Select one option)

0 - 2k Bits (256 Bytes) with 2 Application Areas

Secure Identity Object Programming (Select one option)

- P - Programmed with Security Identity Object (SIO)
- V - Unprogrammed, for use with iCLASS SE Encoder

Front Packaging (Select one option)

- M - Plain White Vinyl with Matte Finish
- G - Plain White with Gloss Finish
- C - Custom Artwork - Specify Custom Artwork Number¹

Back Packaging (Select one option)

- S - Base with Molded HID Logo
- C - Custom Artwork - Specify Custom Artwork Number¹

Card Numbering² (Select one option)

- M - Sequential Matching Encoded/Printed (Inkjetted)⁴
- N - No Printed Card Numbering
- S - Sequential Encoded/Sequential Non-Matching Printed (Inkjetted)³
- R - Random Encoded/Non-Matching Sequential Printed (Inkjetted)³

Slot Punch

V - Vertical Slot Punch

Option - Custom Artwork²

_____ (Specify Artwork Number - Refer to the Custom Artwork Forms for new Artwork)

Enter your final card options from check boxes above. Example: 3350PMSMV

Final Part Number	335						V	-	(Options #)
--------------------------	------------	--	--	--	--	--	----------	----------	--------------------

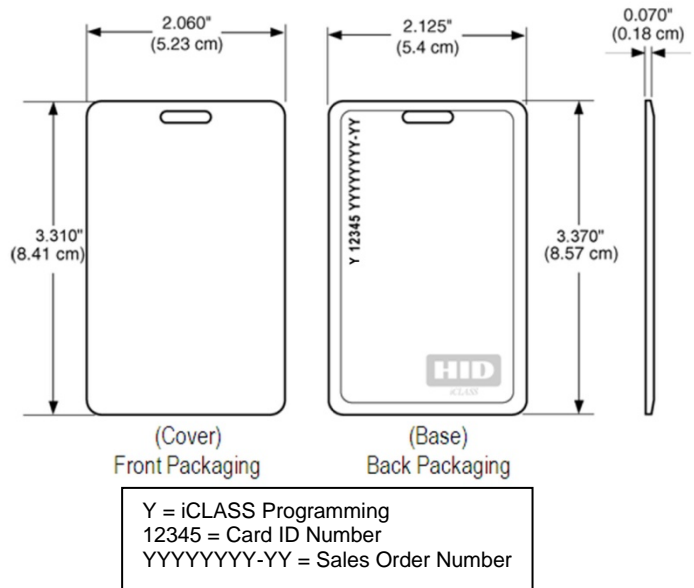

iCLASS Card Programming Information

Format Number _____ (example: H10301) Bit Numbers _____ (example: 26 bit) Facility Code _____
 Encoded Card # Start _____ Stop _____ Printed Card # Start _____ Stop _____
 HID Elite ICE Number (if applicable) - _____ (Custom Format) Site Code _____ City Code _____ OEM Code _____
 Special Instructions: _____

¹ For new artwork files, contact Customer Service for custom artwork number, lead-times, and cost.
² The Printed card number is placed in the top left-hand corner on the back of the card. HID logo molded into base on back.
³ Please note that cards shipped within North America are always laser-engraved. Inkjetted option is not available for these cards.

iCLASS SE + Other HF Card - 391

The SIO-Enabled iCLASS with MIFARE Classic or MIFARE DESFire EV1 contactless smart card offers multiple High Frequency technologies to simplify card issuance for diverse systems or migration projects. This card offers maximized compatibility installations that contain iCLASS SE or MIFARE Classic / MIFARE DESFire EV1 credentials.

Ensure each required option has been checked with the appropriate choice to fulfill a completed order form.

Base Model 391 Composite 40% Polyester / PVC *

iCLASS Memory Size and Allocation (Select one option)

- 0 - 2k Bits (256 Bytes) with 2 Application Areas (only available with MIFARE Classic 1K)
- 3 - 32k Bits (4K Bytes) Application areas 16k/2+16k/1
- 4 - 32k Bits (4K Bytes) Application areas 16k/16+16k/1

Card Programming (Select one option)

- R - SIO Programmed iCLASS & 2nd Technology. Specify Programming Information
- P - SIO Programmed iCLASS only, not 2nd Technology. Specify Programming Information.
- A - Configured, Non-Programmed iCLASS, SIO Programmed 2nd Technology. Specify Programming Information.
- V - iCLASS SE Unprogrammed, for use with iCLASS SE Encoder

2nd High Frequency Technology (Select one option)

- M - MIFARE Classic 1K Bytes (only available with iCLASS 2k bits)
- N - MIFARE Classic 4K Bytes
- K - MIFARE DESFire EV1 8K Bytes

Front Packaging (Select one option)

- G - Plain White with Gloss Finish
- C - Custom Artwork with Gloss Finish - Specify Custom Artwork Number¹

Back Packaging (Select one option)

- G - Plain White with Gloss Finish²
- C - Custom Artwork with Gloss Finish - Specify Custom Artwork Number¹
- 1 - Plain White with Gloss Finish with Magnetic Stripe²
- 3 - Custom Artwork with Gloss Finish with Magnetic Stripe - Specify Custom Artwork Number¹

iCLASS SE Card Numbering³ (Select one option)

- M - Sequential Matching Encoded/Printed (Inkjetted)⁶
- N - No Printed Card Numbering
- S - Sequential Encoded/Sequential Non-Matching Printed (Inkjetted)⁶
- R - Random Encoded/Non-Matching Sequential Printed (Inkjetted)⁶
- A - Sequential Matching Encoded/Printed (Laser Engraved)⁴
- B - Sequential Encoded/Sequential Non-Matching Printed (Laser Engraved)⁴
- C - Random Encoded/Non-Matching Sequential Printed (Laser Engraved)⁴

Slot Punch

IMPORTANT - Dual High Frequency credentials do not allow a slot punch due to the antenna design. HID recommends using a badge holder to attach this card to a lanyard or badge clip.

- N - No Slot Punch

2nd High Frequency Technology Card Numbering³ (Select one option)

- M - Sequential Matching Encoded/Printed (Inkjetted)⁵
- N - No Printed Card Numbering
- S - Sequential Encoded/Sequential Non-Matching Printed (Inkjetted)⁵
- R - Random Encoded/Non-Matching Sequential Printed (Inkjetted)⁵
- A - Sequential Matching Encoded/Printed (Laser Engraved)⁴
- B - Sequential Encoded/Sequential Non-Matching Printed (Laser Engraved)⁴
- C - Random Encoded/Non-Matching Sequential Printed (Laser Engraved)⁴

Option - Custom Artwork¹

- _____ (Specify Artwork Number - Refer to the Custom Artwork Forms for new artwork)

Enter your final card options from the above selections. Example: 3914RNGCMNM

Final Part Number												N	-	(Options #)
-------------------	--	--	--	--	--	--	--	--	--	--	--	---	---	-------------

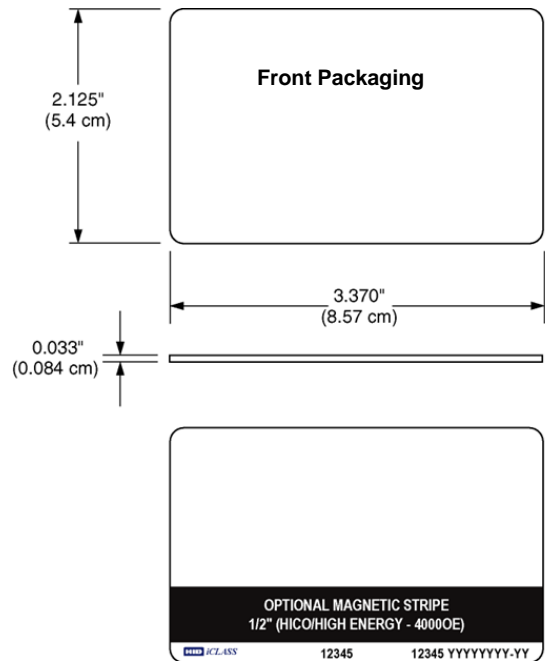

12345 = Card ID Number
 YYYYYYYY-YY = Sales Order Number



iCLASS SE Card Programming Information

Format Number ____ (example: H10301) Bit Numbers ____ (example: 26 bit) Facility Code ____
 Encoded Card # Start ____ Stop ____ Printed Card # Start ____ Stop ____
 HID Elite ICE Number (if applicable) - ____ (Custom Format) Site Code ____ City Code ____ OEM Code ____
 Special Instructions: ____

2nd 13.56 MHz technology Card Programming Information

Format Number ____ (example: H10301) Bit Numbers ____ (example: 26 bit) Facility Code ____
 Encoded Card # Start ____ Stop ____ Printed Card # Start ____ Stop ____
 HID Elite ICE Number (if applicable) - ____ (Custom Format) Site Code ____ City Code ____ OEM Code ____
 Special Instructions: ____

¹ For new artwork files, contact Customer Service for custom artwork number, lead-times, and cost.
² Cards ordered with plain white front and back packaging, or custom artwork, will still have a small HID logo  and reference number printed in the lower left-hand corner and a slot punch target printed on the back of the card.
⁴ For Laser Engraved Printed numbers, consult factory for lead times and cost.
⁵ Please note that cards shipped within North America are always laser-engraved. Inkjetted option is not available for these cards.
 * The composite construction is recommended for all cards with over-laminate applied. Consult with the printer manufacturer prior to ordering.

iCLASS SE + Other 13.56MHz + Prox Card - 396

The SIO-enabled card with MIFARE Classic or MIFARE DESFire EV1 contactless smart card as well as HID Proximity offers multiple High Frequency technologies to simplify card issuance for diverse systems or migration projects. This card offers maximized compatibility into installations that contain iCLASS SE or MIFARE Classic / MIFARE DESFire EV1 credentials.

Ensure each required option has been checked with the appropriate choice to fulfill a completed order form.

Base Model 396 Composite 40% Polyester / PVC *

iCLASS SE Memory Size and Allocation (Select one option)

- 0 - 2k Bits (256 Bytes) with 2 Application Areas (only available with MIFARE Classic 1K)
- 3 - 32k Bits (4K Bytes) Application areas 16k/2+16k/1
- 4 - 32k Bits (4K Bytes) Application areas 16k/16+16k/1

13.56 MHz Technology Card Programming (Select one option)

- R - SIO Programmed iCLASS & 2nd Technology. Specify Programming Information
- P - Programmed iCLASS with SIO only not 2nd Technology. Specify Programming Information.
- A - Configured, Non-Programmed iCLASS, SIO Programmed 2nd Technology. Specify Programming Information.

2nd High Frequency (13.56 MHz) Technology (Select one option)

- M - MIFARE Classic 1K Bytes (only available with iCLASS 2k bits)
- N - MIFARE Classic 4K Bytes
- K - MIFARE DESFire EV1 8K Bytes

125 kHz Technology Card Programming (Select one option)

- P - "HID Prox" Programmed 125 kHz Technology. Specify Programming Information
- C - "Indala/Casi Prox" Programmed 125 kHz Technology. Specify Programming Information
- N - Initialized 125 kHz Technology. Programming Information Not Required

Front Packaging (Select one option)

- G - Plain White with Gloss Finish
- C - Custom Artwork with Gloss Finish - Specify Custom Artwork Number¹

Back Packaging (Select one option)

- G - Plain White with Gloss Finish²
- C - Custom Artwork with Gloss Finish - Specify Custom Artwork Number¹
- 1 - Plain White with Gloss Finish with Magnetic Stripe²
- 3 - Custom Artwork with Gloss Finish with Magnetic Stripe - Specify Custom Artwork Number¹

iCLASS SE Card Numbering³ (Select one option)

- M - Sequential Matching Encoded/Printed (Inkjetted)⁵
- N - No Printed Card Numbering
- S - Sequential Encoded/Sequential Non-Matching Printed (Inkjetted)⁵
- R - Random Encoded/Non-Matching Sequential Printed (Inkjetted)⁵
- A - Sequential Matching Encoded/Printed (Laser Engraved)⁴
- B - Sequential Encoded/Sequential Non-Matching Printed (Laser Engraved)⁴
- C - Random Encoded/Non-Matching Sequential Printed (Laser Engraved)⁴

Slot Punch

IMPORTANT - Dual High Frequency credentials do not allow a slot punch due to the antenna design. HID recommends using a badge holder to attach this card to a lanyard or badge clip.

- N - No Slot Punch

2nd 13.56 MHz Card Numbering³ (Select one option)

- M - Sequential Matching Encoded/Printed (Inkjetted)⁵
- N - No Printed Card Numbering
- S - Sequential Encoded/Sequential Non-Matching Printed (Inkjetted)⁵
- R - Random Encoded/Non-Matching Sequential Printed (Inkjetted)⁵
- A - Sequential Matching Encoded/Printed (Laser Engraved)⁴
- B - Sequential Encoded/Sequential Non-Matching Printed (Laser Engraved)⁴
- C - Random Encoded/Non-Matching Sequential Printed (Laser Engraved)⁴

125 kHz Card Numbering³ (Select one option)

- M - Sequential Matching Encoded/Printed (Inkjetted)⁵
- N - No Printed Card Numbering
- S - Sequential Encoded/Sequential Non-Matching Printed (Inkjetted)⁵
- R - Random Encoded/Non-Matching Sequential Printed (Inkjetted)⁵
- A - Sequential Matching Encoded/Printed (Laser Engraved)⁴
- B - Sequential Encoded/Sequential Non-Matching Printed (Laser Engraved)⁴
- C - Random Encoded/Non-Matching Sequential Printed (Laser Engraved)⁴

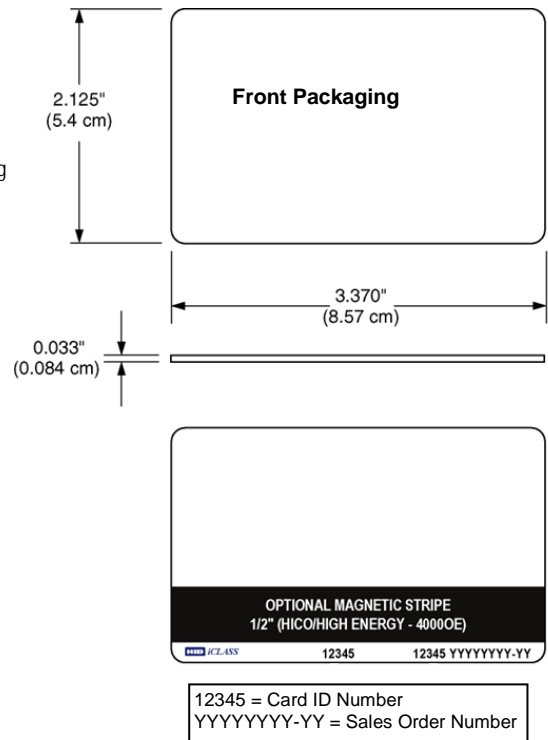



Option - Custom Artwork¹

_____ (Specify Artwork Number - Refer to the Custom Artwork Forms for new artwork)

Enter your final card options from the above selections. Example: 3964PNPGGNNM

Final Part Number									N				-	(Options #)
--------------------------	--	--	--	--	--	--	--	--	----------	--	--	--	---	--------------------

iCLASS SE Programming Information

Format Number _____ (example: H10301) Bit Numbers _____ (example: 26 bit) Facility Code _____
 Encoded Card # Start _____ Stop _____ Printed Card # Start _____ Stop _____
 HID Elite ICE Number (if applicable) - _____ (Custom Format) Site Code _____ City Code _____ OEM Code _____
 Special Instructions: _____

2nd 13.56 MHz Programming Information

Format Number _____ (example: H10301) Bit Numbers _____ (example: 26 bit) Facility Code _____
 Encoded Card # Start _____ Stop _____ Printed Card # Start _____ Stop _____
 HID Elite ICE Number (if applicable) - _____ (Custom Format) Site Code _____ City Code _____ OEM Code _____
 Special Instructions: _____

125 kHz Programming Information

Format Number _____ (example: H10301) Bit Numbers _____ (example: 26 bit) Facility Code _____
 Encoded Card # Start _____ Stop _____ Printed Card # Start _____ Stop _____
 HID Elite ICE Number (if applicable) - _____ (Custom Format) Site Code _____ City Code _____ OEM Code _____
 Special Instructions: _____

¹ For new artwork files, contact Customer Service for custom artwork number, lead-times, and cost.
² Cards ordered with plain white front and back packaging, or custom artwork, will still have a small HID logo and reference number printed in the lower left-hand corner and a slot punch target printed on the back of the card.
³ The Printed card number is placed in the bottom right-hand corner for iCLASS 13.56 MHz and in the bottom center for 125 kHz Proximity on the back of the card.
⁴ For Laser Engraved Printed numbers, consult factory for lead times and cost.
⁵ Please note that cards shipped within North America are always laser-engraved. Inkjetted option is not available for these cards.
 * The composite construction is recommended for all cards with over-laminate applied. Consult with the printer manufacturer prior to ordering.

iCLASS Credentials

iCLASS Card - 200 / 210

iCLASS cards can be ordered either with both SIO and iCLASS programming or iCLASS programming only. Ensure each required option has been checked with the appropriate choice to fulfill a completed order form.

Base Model: 200 Standard PVC 210 Composite 40% Polyester / PVC*

iCLASS Memory Size and Allocation (Select one option)

- 0 - 2k Bits (256 Bytes) with 2 Application Areas
- 3 - 32k Bits (4K Bytes) Application areas 16k/2+16k/1
- 4 - 32k Bits (4K Bytes) Application areas 16k/16+16k/1

iCLASS Programming (Select one option)

- HP - Programmed with Security Identity Object (SIO) and standard iCLASS Access Control Application (Recommended)¹
- P - Programmed with standard iCLASS Access Control Application
- C - Unprogrammed, for use with iCLASS SE Encoder

Front Packaging (Select one option)

- G - Plain White with Gloss Finish
- C - Custom Artwork with Gloss Finish - Specify Custom Artwork Number²

Back Packaging (Select one option)

- G - Plain White with Gloss Finish³
- C - Custom Artwork with Gloss Finish - Specify Custom Artwork Number²
- 1 - Plain White with Gloss Finish with Magnetic Stripe³
- 3 - Custom Artwork with Gloss Finish with Magnetic Stripe - Specify Custom Artwork Number²

Card Numbering⁴ (Select one option)

- M - Sequential Matching Encoded/Printed (Inkjetted)⁸
- N - No Printed Card Numbering
- S - Sequential Encoded/Sequential Non-Matching Printed (Inkjetted)⁸
- R - Random Encoded/Non-Matching Sequential Printed (Inkjetted)⁸
- A - Sequential Matching Encoded/Printed (Laser Engraved)⁵
- B - Sequential Encoded/Sequential Non-Matching Printed (Laser Engraved)⁵
- C - Random Encoded/Non-Matching Sequential Printed (Laser Engraved)⁵

Slot Punch⁶ (Select one option)

- N - No slot punch, This card can be slotted vertically, Printed Vertical Slot Indicators
- B - No Slot Punch, This card can be slotted horizontally, Printer VHorizontal Slot Indicators⁷
- V - Vertical Slot Punch
- H - Horizontal Slot Punch⁷

Option - Custom Artwork²

_____ (Specify Artwork Number - Refer to the Custom Artwork Forms for new artwork)

Enter your final card options from check boxes above. Example: 2000HPGGNN

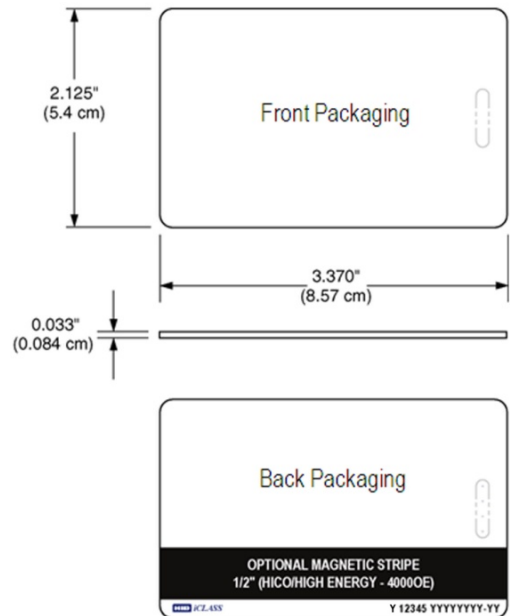

Y = iCLASS Programming
 12345 = Card ID Number
 YYYYYYYY-YY = Sales Order Number

Final Part Number									-	(Options #)
--------------------------	--	--	--	--	--	--	--	--	---	--------------------

iCLASS Card Programming Information

Format Number ____ (example: H10301) Bit Numbers ____ (example: 26 bit) Facility Code ____
 Encoded Card # Start ____ Stop ____ Printed Card # Start ____ Stop ____
 HID Elite ICE Number (if applicable) - ____ (Custom Format) Site Code ____ City Code ____ OEM Code ____
 PIN (2-12 digits): Sequential: Start # _____ Random: Length _____

Special Instructions: _____

¹ Secure Identity Object (SIO) Programming is not mandatory but highly recommended. If SIO programming is not selected the letter H should be left out from Final Part Number, for example: 2000PGGNN
² For new artwork files, contact Customer Service for custom artwork number, lead-times, and cost.
³ Cards ordered with plain white front and back packaging, or custom artwork, will still have a small HID logo and reference number printed in the lower left-hand corner and a slot punch target printed on the back of the card.
⁴ The Printed card number is placed in the bottom right-hand corner on the back of the card.
⁵ For Laser Engraved Printed numbers, consult factory for lead times and cost.
⁶ Cards are provided with an optional slot punch at no additional charge. Some video imaging printers cannot accommodate pre-slot punched cards.
⁷ The ability to add a horizontal slot punch requires a different iCLASS antenna design. Users can expect a read range reduction of approximately 20% if they order option H for the Slot Punch.
⁸ Please note that cards shipped within North America are always laser-engraved. Inkjetted option is not available for these cards.

* The composite construction is recommended for all cards with over-laminate applied. Consult with the printer manufacturer prior to ordering.



iCLASS + Prox card - 202 / 212

iCLASS + Prox cards can be ordered either with both SIO and iCLASS programming or iCLASS programming only.

Ensure each required option has been checked with the appropriate choice to fulfill a completed order form.

Base Model 202 Standard PVC 212 Composite 40% Polyester / PVC*

iCLASS Memory Size and Allocation (Select one option)

- 0 - 2k Bits (256 Bytes) with 2 Application Areas
- 3 - 32k Bits (4K Bytes) Application areas 16k/2+16k/1
- 4 - 32k Bits (4K Bytes) Application areas 16k/16+16k/1

Programming (Select one option)

- HP - Programmed with Security Identity Object (SIO), and standard iCLASS Access control application, 125KHz Unprogrammed.¹
- HB - Programmed with Security Identity Object (SIO), and standard iCLASS Access control application, programmed, Specify Programming Information¹
- P - Programmed with standard iCLASS Access Control Application, 125 KHz Unprogrammed.
- B - Programmed 125 kHz Proximity and iCLASS. Specify Programming Information.
- C - iCLASS Unprogrammed, for use with iCLASS SE Encoder, Prox technology blank.
- A - iCLASS Unprogrammed, for use with iCLASS SE Encoder, Prox technology programmed. Specify Programming Information.
- K - iCLASS Programmed, HITAG1 blank. Specify Programming Information.
- M - iCLASS Programmed, HITAG2 blank. Specify Programming Information.
- R - iCLASS configured field programmable, HITAG1 blank.
- I - iCLASS configured field programmable, HITAG2 blank.

Front Packaging (Select one option)

- G - Plain White with Gloss Finish
- C - Custom Artwork with Gloss Finish - Specify Custom Artwork Number²

Back Packaging (Select one option)

- G - Plain White with Gloss Finish³
- C - Custom Artwork with Gloss Finish - Specify Custom Artwork Number²
- 1 - Plain White with Gloss Finish with Magnetic Stripe³
- 3 - Custom Artwork with Gloss Finish with Magnetic Stripe - Specify Custom Artwork Number²

iCLASS Card Numbering⁴ (Select one option)

- M - Sequential Matching Encoded/Printed (Inkjetted)⁷
- N - No Printed Card Numbering
- S - Sequential Encoded/Sequential Non-Matching Printed (Inkjetted)⁷
- R - Random Encoded/Non-Matching Sequential Printed (Inkjetted)⁷
- A - Sequential Matching Encoded/Printed (Laser Engraved)⁵
- B - Sequential Encoded/Sequential Non-Matching Printed (Laser Engraved)⁵
- C - Random Encoded/Non-Matching Sequential Printed (Laser Engraved)⁵

Slot Punch⁶ (Select one option)

- V - Vertical Slot Punch
- N - No slot punch, This card can be slotted vertically, Printed Vertical Slot Indicators

125 kHz Card Numbering⁴ (Select one option)

- M - Sequential Matching Encoded/Printed (Inkjetted)⁷
- N - No Printed Card Numbering
- S - Sequential Encoded/Sequential Non-Matching Printed (Inkjetted)⁷
- R - Random Encoded/Non-Matching Sequential Printed (Inkjetted)⁷
- A - Sequential Matching Encoded/Printed (Laser Engraved)⁵
- B - Sequential Encoded/Sequential Non-Matching Printed (Laser Engraved)⁵
- C - Random Encoded/Non-Matching Sequential Printed (Laser Engraved)⁵

Option - Custom Artwork²

_____ (Specify Artwork Number - Refer to the Custom Artwork Forms for new artwork)

Enter your final card options from the above selections. Example: 2020HPGGNNN

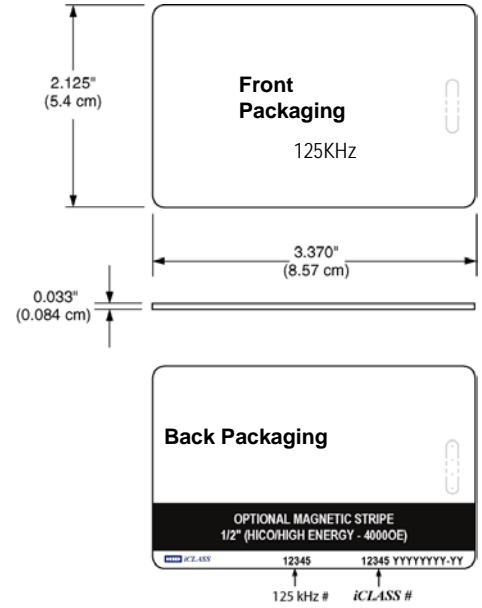

12345 = Card ID Number
 YYYYYYYY-YY = Sales Order Number

Final Part Number										-	(Options #)
-------------------	--	--	--	--	--	--	--	--	--	---	-------------



iCLASS Card Programming Information

Format Number ____ (example: H10301) Bit Numbers ____ (example: 26 bit) Facility Code ____
Encoded Card # Start ____ Stop ____ Printed Card # Start ____ Stop ____
HID Elite ICE Number (if applicable) - ____ (Custom Format) Site Code ____ City Code ____ OEM Code ____
PIN (2-12 digits): Sequential: Start # _____ Random: Length _____
Special Instructions: _____

125 kHz Card Programming Information

Format Number ____ (example: H10301) Bit Numbers ____ (example: 26 bit) Facility Code ____
Encoded Card # Start ____ Stop ____ Printed Card # Start ____ Stop ____
HID Elite ICE Number (if applicable) - ____ (Custom Format) Site Code ____ City Code ____ OEM Code ____
Special Instructions: _____

- ¹ Secure Identity Object (SIO) Programming is not mandatory but highly recommended. If SIO programming is not selected the letter H should be left out from Final Part Number, for example: 2020PGNNN
- ² For new artwork files, contact Customer Service for custom artwork number, lead-times, and cost.
- ³ Cards ordered with plain white front and back packaging, or custom artwork, will still have a small HID logo  and reference number printed in the lower left-hand corner and a slot punch target printed on the back of the card.
- ⁴ The Printed card number is placed in the bottom right-hand corner for iCLASS 13.56 MHz and in the bottom center for 125 kHz Proximity on the back of the card.
- ⁵ For Laser Engraved Printed numbers, consult factory for lead times and cost.
- ⁶ Cards are provided with an optional slot punch at no additional charge. Some video imaging printers cannot accommodate pre-slot punched cards.
- ⁷ Please note that cards shipped within North America are always laser-engraved. Inkjetted option is not available for these cards.
- * The composite construction is recommended for all cards with over-laminate applied. Consult with the printer manufacturer prior to ordering.

iCLASS Key - 205

The iCLASS Key can be ordered either with both SIO and iCLASS programming or iCLASS programming only. Attach to a key ring or badge clip for convenient use.

Ensure each required option has been checked with the appropriate choice to fulfill a completed order form.

Base Model 205 Base Model

iCLASS Memory Size and Allocation (Select one option)

- 0 - 2k Bits (256 Bytes) with 2 Application Areas
- 3 - 32k Bits (4K Bytes) Application areas 16k/2+16k/1
- 4 - 32k Bits (4K Bytes) Application areas 16k/16+16k/1

Programming (Select one option)

- H - Programmed with Security Identity Object (SIO) and iCLASS encoding (Recommended). Specify programming information.
- P - Programmed iCLASS only. Specify programming information
- C - iCLASS Unprogrammed, for use with iCLASS SE Encoder. Programming Information Not Required

Front Packaging

- N - iCLASS Key II - Black with blue insert. Includes HID Standard Artwork

Back Packaging

- N - None

Key Numbering¹ (Select one option)

- M - Sequential Matching Encoded/Printed (Inkjetted)⁴
- N - No Printed Key Numbering
- S - Sequential Encoded/Sequential Non-Matching Printed (Inkjetted)⁴
- R - Random Encoded/Non-Matching Sequential Printed (Inkjetted)⁴
- A - Sequential Matching Encoded/Printed (Engraved)²
- B - Sequential Encoded/Sequential Non-Matching Printed (Engraved)²
- C - Random Encoded/Non-Matching Sequential Printed (Engraved)²

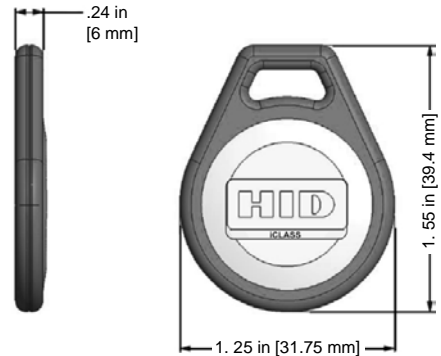

Additional Options³

- N - None

Enter your final card options from the above selections. Example: 2050HNNMN

Final Part Number	205			N	N		N
--------------------------	------------	--	--	----------	----------	--	----------

iCLASS Key Programming Information

Format Number ____ (example: H10301) Bit Numbers ____ (example: 26 bit) Facility Code ____
 Encoded Card # Start ____ Stop ____ Printed Card # Start ____ Stop ____
 HID Elite ICE Number (if applicable) - ____ (Custom Format) Site Code ____ City Code ____ OEM Code ____
 PIN (2-12 digits) : Sequential: Start # _____ Random: Length _____
 Special Instructions: _____

¹ The Printed key number is placed on the back of the key.
² For Laser Engraved Printed numbers, consult factory for lead times and cost.
³ Key Ring sold separately (Part Number: 57-0001-02) .
⁴ Please note that cards shipped within North America are always laser-engraved. Inkjetted option is not available for these cards.

iCLASS Tag - 206

The iCLASS contactless smart Tag can be ordered either with both SIO and iCLASS programming or iCLASS programming only. iCLASS enable existing credentials or non-metallic devices such as cell phones or PDAs by adhering the iCLASS Tag.

Ensure each required option has been checked with the appropriate choice to fulfill a completed order form.

206 Base Model

iCLASS Memory Size and Allocation (Select one option)

- 0 - 2k Bits (256 Bytes) with 2 Application Areas
- 3 - 32k Bits (4K Bytes) Application areas 16k/2+16k/1
- 4 - 32k Bits (4K Bytes) Application areas 16k/16+16k/1

iCLASS Programming information (Select one option)

- H - Programmed with Security Identity Object (SIO) and iCLASS encoding. Specify programming information. (Recommended)
- P - Programmed with iCLASS access control application only. Specify programming information.
- C - iCLASS Unprogrammed, for use with iCLASS SE Encoder. Programming Information Not Required.

Front Packaging (Select one option)

- K - Black with HID Standard Artwork
- C - Custom Artwork - Specify Custom Artwork Number²

Back Packaging

- S - Adhesive Backing

Tag Numbering¹(Select one option)

- M - Sequential Matching Encoded/Printed (Inkjetted)⁴
- N - No Printed Tag Numbering
- S - Sequential Encoded/Sequential Non-Matching Printed (Inkjetted)⁴
- R - Random Encoded/Non-Matching Sequential Printed (Inkjetted)⁴

Slot Punch

- N - None

Option - Custom Artwork¹

- _____ (Specify Artwork Number - Refer to the Custom Artwork Forms for new artwork)

Enter your final Tag options from check boxes above. Example: 2060HSSNN

Final Part Number	206				S		N	-	(Options #)
--------------------------	------------	--	--	--	----------	--	----------	---	--------------------

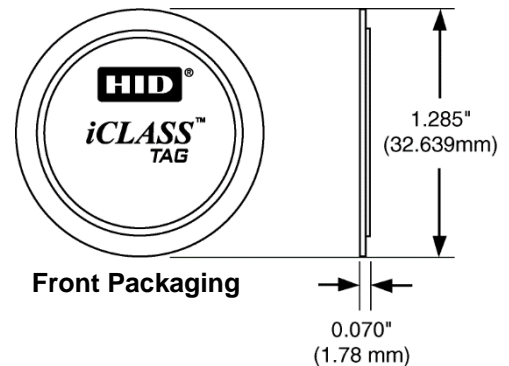

iCLASS Tag Programming Information

Format Number ____ (example: H10301) Bit Numbers ____ (example: 26 bit) Facility Code ____
 Encoded Card # Start ____ Stop ____ Printed Card # Start ____ Stop ____
 HID Elite ICE Number (if applicable) - ____ (Custom Format) Site Code ____ City Code ____ OEM Code ____
 PIN (2-12 digits) : Sequential: Start # _____ Random: Length _____
 Special Instructions: _____

¹ The Printed tag number is placed on the back of the tag.
² For new artwork files, contact Customer Service for custom artwork number, lead-times, minimum order quantities, and cost.
³ The iCLASS Tag is not for use on cards that use full insertion or tractor feed type readers.
⁴ Please note that cards shipped out of Austin, Texas are always laser-engraved. Inkjetted option is not available for these cards.

Do not adhere to metal surfaces. Metal shields the RF, making the tag inoperable. Due to variations in cards and reading devices, HID does not claim that the iCLASS Tag will work in every situation. Functional and non-functional iCLASS Tags are available for compatibility testing with existing credential and reader technologies. Compatibility should be confirmed prior to ordering.



Contact Smart Chip

Magnetic Stripe card



iCLASS Clamshell Card - 208

Can be ordered either with both SIO and iCLASS programming or iCLASS programming only.

Ensure each required option has been checked with the appropriate choice to fulfill a completed order form.

208 Base Model

iCLASS Memory Size and Allocation

0 - 2k Bits (256 Bytes) with 2 Application Areas

iCLASS Programming (Select one option)

- HP - Programmed with Security Identity Object (SIO) and standard iCLASS Access Control Application. Programming information required. **(Recommended)**¹
- P - Programmed with standard iCLASS Access Control Application only. Programming information required.
- C - iCLASS Unprogrammed, for use with iCLASS SE Encoder. Programming Information Not Required.

Front Packaging (Select one option)

- M - Plain White Vinyl with Matte Finish
- G - Plain White with Gloss Finish
- C - Custom Artwork - Specify Custom Artwork Number²

Back Packaging (Select one option)

- S - Base with Molded HID Logo
- C - Custom Artwork - Specify Custom Artwork Number²

Card Numbering⁴ (Select one option)

- M - Sequential Matching Encoded/Printed (Inkjetted)³
- N - No Printed Card Numbering
- S - Sequential Encoded/Sequential Non-Matching Printed (Inkjetted)³
- R - Random Encoded/Non-Matching Sequential Printed (Inkjetted)³

Slot Punch

V - Vertical Slot Punch

Option - Custom Artwork²

_____ (Specify Artwork Number - Refer to the Custom Artwork Forms for new Artwork)

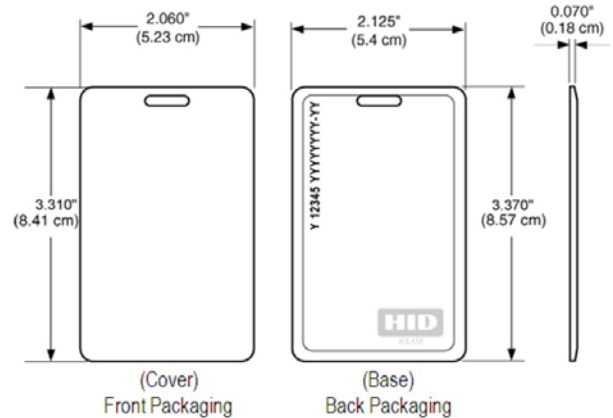

Y = iCLASS Programming
 12345 = Card ID Number
 YYYYYYYY-YY = Sales Order Number

Enter your final card options from check boxes above. Example: 2080HPGSNV

Final Part Number	208						V	-	(Options #)
--------------------------	------------	--	--	--	--	--	----------	----------	--------------------

iCLASS Card Programming Information

Format Number _____ (example: H10301) Bit Numbers _____ (example: 26 bit) Facility Code _____
 Encoded Card # Start _____ Stop _____ Printed Card # Start _____ Stop _____
 HID Elite ICE Number (if applicable) - _____ (Custom Format) Site Code _____ City Code _____ OEM Code _____
 PIN (2-12 digits) : Sequential: Start # _____ Random: Length _____
 Special Instructions: _____

¹ Secure Identity Object (SIO) Programming is not mandatory but highly recommended. If SIO programming is not selected the letter H should be left out from Final Part Number, for example: 2080PGSNV
² For new artwork files, contact Customer Service for custom artwork number, lead-times, and cost.
³ Please note that cards shipped within North America are always laser-engraved. Inkjetted option is not available for these cards.

iCLASS + Other HF Card - 242

iCLASS with MIFARE Classic or MIFARE DESFire EV1 contactless smart card offers multiple High Frequency technologies to simplify card issuance for diverse systems or migration projects. For MIFARE Classic: This credential is only delivered with MIFARE Classic UID 4 Bytes long only (32 Bit). It is not available with 7 bytes UID for MIFARE Classic, only for MIFARE DESFire EV1.

Ensure each required option has been checked with the appropriate choice to fulfill a completed order form.

Base Model 242 Composite 40% Polyester / PVC *

iCLASS Memory Size and Allocation (Select one option)

- 0 - 2k Bits (256 Bytes) with 2 Application Areas (only available with MIFARE Classic 1K)
- 3 - 32k Bits (4K Bytes) Application areas 16k/2+16k/1
- 4 - 32k Bits (4K Bytes) Application areas 16k/16+16k/1

Card Programming (Select one option)

- J - Programmed with SIO Identity Object (SIO) iCLASS and 2nd technology (Recommended)
- H - Programmed with Security Identity Object (SIO) for iCLASS only
- I - Programmed with SIO Identity Object (SIO) for 2nd technology only
- B - Programmed iCLASS & 2nd Technology. Specify Programming Information.
- P - Programmed iCLASS only not 2nd Technology. Specify Programming Information.
- C - Unprogrammed iCLASS, for use with iCLASS SE Encoder, Non-programmed 2nd Technology. Programming Information Not Required.
- A - Unprogrammed iCLASS, for use with iCLASS SE Encoder, Programmed 2nd Technology. Specify Programming Information

2nd High Frequency Technology (Select one option)

- M - MIFARE Classic 1K Bytes (only available with iCLASS 2k bits)
- N - MIFARE Classic 4K Bytes
- K - MIFARE DESFire EV1 8K Bytes

Front Packaging (Select one option)

- G - Plain White with Gloss Finish
- C - Custom Artwork with Gloss Finish - Specify Custom Artwork Number¹

Back Packaging (Select one option)

- G - Plain White with Gloss Finish²
- C - Custom Artwork with Gloss Finish - Specify Custom Artwork Number¹
- 1 - Plain White with Gloss Finish with Magnetic Stripe²
- 3 - Custom Artwork with Gloss Finish with Magnetic Stripe - Specify Custom Artwork Number¹

iCLASS Card Numbering³ (Select one option)

- M - Sequential Matching Encoded/Printed (Inkjetted)⁶
- N - No Printed Card Numbering
- S - Sequential Encoded/Sequential Non-Matching Printed (Inkjetted)⁶
- R - Random Encoded/Non-Matching Sequential Printed (Inkjetted)⁶
- A - Sequential Matching Encoded/Printed (Laser Engraved)⁶
- B - Sequential Encoded/Sequential Non-Matching Printed (Laser Engraved)⁴
- C - Random Encoded/Non-Matching Sequential Printed (Laser Engraved)⁴

Slot Punch

IMPORTANT - Dual High Frequency credentials do not allow a slot punch due to the antenna design. HID recommends using a badge holder to attach this card to a lanyard or badge clip.

- N - No Slot Punch

2nd High Frequency Technology Card Numbering³ (Select one option)

- M - Sequential Matching Encoded/Printed (Inkjetted)⁶
- N - No Printed Card Numbering
- S - Sequential Encoded/Sequential Non-Matching Printed (Inkjetted)⁶
- R - Random Encoded/Non-Matching Sequential Printed (Inkjetted)⁶
- A - Sequential Matching Encoded/Printed (Laser Engraved)⁴
- B - Sequential Encoded/Sequential Non-Matching Printed (Laser Engraved)⁴
- C - Random Encoded/Non-Matching Sequential Printed (Laser Engraved)⁴

Option - Custom Artwork¹

- _____ (Specify Artwork Number - Refer to the Custom Artwork Forms for new artwork)

Enter your final card options from the above selections. Example: 2420HNGGNNN

Final Part Number										N			-	(Options #)
-------------------	--	--	--	--	--	--	--	--	--	---	--	--	---	-------------

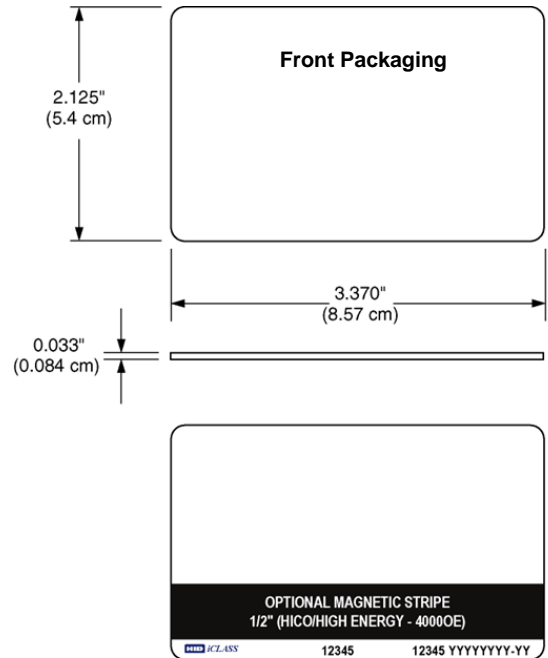

12345 = Card ID Number
 YYYYYYYY-YY = Sales Order Number



iCLASS Card Programming Information

Format Number ____ (example: H10301) Bit Numbers ____ (example: 26 bit) Facility Code ____
 Encoded Card # Start ____ Stop ____ Printed Card # Start ____ Stop ____
 HID Elite ICE Number (if applicable) - ____ (Custom Format) Site Code ____ City Code ____ OEM Code ____
 PIN (2-12 digits) : Sequential: Start # _____ Random: Length _____
 Special Instructions: _____

2nd 13.56MHz Technology Card Programming Information

Format Number ____ (example: H10301) Bit Numbers ____ (example: 26 bit) Facility Code ____
 Encoded Card # Start ____ Stop ____ Printed Card # Start ____ Stop ____
 HID Elite ICE Number (if applicable) - ____ (Custom Format) Site Code ____ City Code ____ OEM Code ____
 Special Instructions: _____

¹ For new artwork files, contact Customer Service for custom artwork number, lead-times, and cost.
² Cards ordered with plain white front and back packaging, or custom artwork, will still have a small HID logo  and reference number printed in the lower left-hand corner and a slot punch target printed on the back of the card.
³ The Printed card number is placed in the bottom right-hand corner for iCLASS 13.56 MHz and in the bottom center for 125 kHz Proximity on the back of the card.
⁴ For Laser Engraved Printed numbers, consult factory for lead times and cost.
⁵ Cards are provided with an optional slot punch at no additional charge. Some video imaging printers cannot accommodate pre-slot punched cards.
⁶ Please note that cards shipped within North America are always laser-engraved. Inkjetted option is not available for these cards.
 * The composite construction is recommended for all cards with over-laminate applied. Consult with the printer manufacturer prior to ordering.



iCLASS + Other 13.56 MHz + Prox Card - 262

The iCLASS with MIFARE Classic or MIFARE DESFire EV1 contactless smart card as well as HID Proximity offers multiple High Frequency technologies to simplify card issuance for diverse systems or migration projects. For MIFARE Classic: This credential is only delivered with MIFARE Classic UID on 4 Bytes long only (32 Bit). It is not available with 7 bytes UID for MIFARE Classic, only for MIFARE DESFire EV1.

Ensure each required option has been checked with the appropriate choice to fulfill a completed order form.

Base Model 262 Composite 40% Polyester / PVC *

iCLASS Memory Size and Allocation (Select one option)

- 0 - 2k Bits (256 Bytes) with 2 Application Areas (only available with MIFARE Classic 1K)
- 3 - 32k Bits (4K Bytes) Application areas 16k/2+16k/1
- 4 - 32k Bits (4K Bytes) Application areas 16k/16+16k/1

iCLASS / 2nd 13.56MHz Programming

- J - Programmed with SIO Identity Object (SIO) for iCLASS and 2nd technology programmed with SIO (Recommended).
- H - Programmed with Security Identity Object (SIO) for CLASS only.
- I - Programmed with SIO Identity Object only (SIO) for 2nd technology only.
- K - Programmed with SIO Identity Object (SIO) for iCLASS and 2nd technology programmed (non SIO).
- B - Programmed iCLASS & 2nd Technology. Specify Programming Information.
- P - Programmed iCLASS only not 2nd Technology. Specify Programming Information.
- C - Unprogrammed iCLASS, for use with iCLASS SE Encoder. Non-programmed 2nd Technology. Programming Information Not Required.
- A - Unprogrammed iCLASS, for use with iCLASS SE Encoder, Programmed 2nd Technology. Specify Programming Information.

Other 13.56 MHz Technology (Select one option)

- M - MIFARE Classic 1K Bytes (only available with iCLASS 2k bits)
- N - MIFARE Classic 4K Bytes
- K - MIFARE DESFire EV1 8K Bytes

125 kHz Technology Card Programming (Select one option)

- P - "HID Prox" Programmed 125 kHz Technology. Specify Programming Information.
- C - "Indala/Casi Prox" Programmed 125 kHz Technology. Specify Programming Information.
- N - Initialized 125 kHz Technology. Programming Information Not Required.

Front Packaging (Select one option)

- G - Plain White with Gloss Finish
- C - Custom Artwork with Gloss Finish - Specify Custom Artwork Number¹

Back Packaging (Select one option)

- G - Plain White with Gloss Finish²
- C - Custom Artwork with Gloss Finish - Specify Custom Artwork Number¹
- 1 - Plain White with Gloss Finish with Magnetic Stripe²
- 3 - Custom Artwork with Gloss Finish with Magnetic Stripe - Specify Custom Artwork Number¹

iCLASS Card Numbering³ (Select one option)

- M - Sequential Matching Encoded/Printed (Inkjetted)⁵
- N - No Printed Card Numbering
- S - Sequential Encoded/Sequential Non-Matching Printed (Inkjetted)⁵
- R - Random Encoded/Non-Matching Sequential Printed (Inkjetted)⁵
- A - Sequential Matching Encoded/Printed (Laser Engraved)⁴
- B - Sequential Encoded/Sequential Non-Matching Printed (Laser Engraved)⁴
- C - Random Encoded/Non-Matching Sequential Printed (Laser Engraved)⁴

Slot Punch

IMPORTANT - Dual High Frequency credentials do not allow a slot punch due to the antenna design. HID recommends using a badge holder to attach this card to a lanyard or badge clip.

- N - No Slot Punch

2nd 13.56 MHz Card Numbering³ (Select one option)

- M - Sequential Matching Encoded/Printed (Inkjetted)⁵
- N - No Printed Card Numbering
- S - Sequential Encoded/Sequential Non-Matching Printed (Inkjetted)⁵
- R - Random Encoded/Non-Matching Sequential Printed (Inkjetted)⁵
- A - Sequential Matching Encoded/Printed (Laser Engraved)⁴
- B - Sequential Encoded/Sequential Non-Matching Printed (Laser Engraved)⁴
- C - Random Encoded/Non-Matching Sequential Printed (Laser Engraved)⁴

125 kHz Card Numbering³ (Select one option)

- M - Sequential Matching Encoded/Printed (Inkjetted)⁵
- N - No Printed Card Numbering
- S - Sequential Encoded/Sequential Non-Matching Printed (Inkjetted)⁵
- R - Random Encoded/Non-Matching Sequential Printed (Inkjetted)⁵
- A - Sequential Matching Encoded/Printed (Laser Engraved)⁴
- B - Sequential Encoded/Sequential Non-Matching Printed (Laser Engraved)⁴
- C - Random Encoded/Non-Matching Sequential Printed (Laser Engraved)⁴



Option - Custom Artwork¹

_____ (Specify Artwork Number - Refer to the Custom Artwork Forms for new artwork)

Enter your final card options from the above selections. Example: 2624JNGGNNN

Final Part Number										N			-			(Options #)
--------------------------	--	--	--	--	--	--	--	--	--	----------	--	--	---	--	--	--------------------

iCLASS Card Programming Information

Format Number ____ (example: H10301) Bit Numbers ____ (example: 26 bit) Facility Code ____
 Encoded Card # Start ____ Stop ____ Printed Card # Start ____ Stop ____
 HID Elite ICE Number (if applicable) - ____ (Custom Format) Site Code ____ City Code ____ OEM Code ____
 PIN (2-12 digits) : Sequential: Start # _____ Random: Length _____
 Special Instructions: _____

2nd 13.56 MHz Card Programming Information

Format Number ____ (example: H10301) Bit Numbers ____ (example: 26 bit) Facility Code ____
 Encoded Card # Start ____ Stop ____ Printed Card # Start ____ Stop ____
 HID Elite ICE Number (if applicable) - ____ (Custom Format) Site Code ____ City Code ____ OEM Code ____
 Special Instructions: _____

125 kHz Card Programming Information

Format Number ____ (example: H10301) Bit Numbers ____ (example: 26 bit) Facility Code ____
 Encoded Card # Start ____ Stop ____ Printed Card # Start ____ Stop ____
 HID Elite ICE Number (if applicable) - ____ (Custom Format) Site Code ____ City Code ____ OEM Code ____
 Special Instructions: _____

¹ For new artwork files, contact Customer Service for custom artwork number, lead-times, and cost.
² Cards ordered with plain white front and back packaging, or custom artwork, will still have a small HID logo and reference number printed in the lower left-hand on the back of the card.
³ The Printed card number is placed in the bottom right-hand corner for iCLASS 13.56 MHz and in the bottom center for 125 kHz Proximity on the back of the card.
⁴ For Laser Engraved Printed numbers, consult factory for lead times and cost.
⁵ Please note that cards shipped within North America are always laser-engraved. Inkjetted option is not available for these cards.

* The composite construction is recommended for all cards with over-laminate applied. Consult with the printer manufacturer prior to ordering.

UHF Credentials

UHF Card - 600

The SIO Enabled UHF (Ultra High Frequency: 860-960 MHz) contactless smart card is designed for long read range (parking, gate, healthcare...) while leveraging your investment in existing access control systems. Personalize the card with a photo ID, magnetic stripe, barcode, or anti-counterfeiting element. **Direct to Card printing on these cards is not recommended.**

Ensure each required option has been checked with the appropriate choice to fulfill a completed order form.

Base Model 600 Composite 40% Polyester / PVC *

Secure Identity Object Programming

T - UHF Programmed with Secure Identity Object.

Front Packaging (Select one option)

- G - Plain White with Gloss Finish
- C - Custom Artwork with Gloss Finish - Specify Custom Artwork Number¹

Back Packaging (Select one option)

- G - Plain White with Gloss Finish²
- C - Custom Artwork with Gloss Finish - Specify Custom Artwork Number¹
- 1 - Plain White with Gloss Finish with Magnetic Stripe²
- 3 - Custom Artwork with Gloss Finish with Magnetic Stripe - Specify Custom Artwork Number¹

UHF Card Numbering³ (Select one option)

- N - No Printed Card Numbering
- A - Sequential Matching Encoded/Printed (Laser Engraved)⁴
- B - Sequential Encoded/Sequential Non-Matching Printed (Laser Engraved)⁴
- C - Random Encoded/Non-Matching Sequential Printed (Laser Engraved)⁴

Slot Punch

N - No Slot Punch

Option - Custom Artwork¹

_____ (Specify Artwork Number - Refer to the Custom Artwork Forms for new artwork)

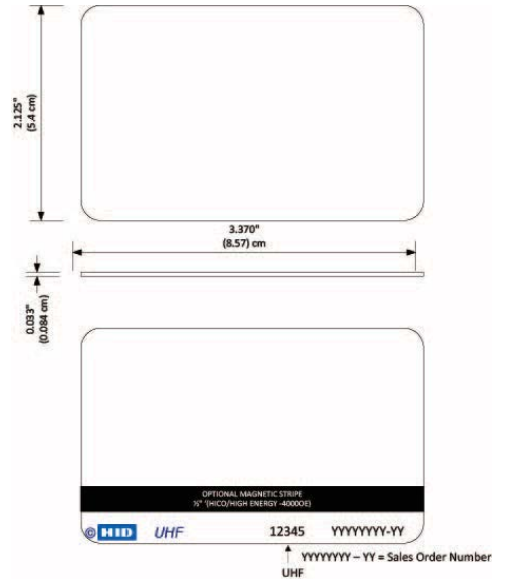

Enter your final card options from the above selections. Example: 600TGGNN

Final Part Number	600	T				N	-	(Options #)
-------------------	-----	---	--	--	--	---	---	-------------

UHF Programming Information

Format Number _____ (example: H10301) Bit Numbers⁵ _____ (example: 26 bit) Facility Code _____
 Encoded Card # Start _____ Stop _____ Printed Card # Start _____ Stop _____
 HID Elite ICE Number (if applicable) - _____ (Custom Format) Site Code _____ City Code _____ OEM Code _____
 Special Instructions: _____

¹ For new artwork files, contact Customer Service for custom artwork number, lead-times, and cost.
² Cards ordered with plain white front and back packaging, or custom artwork, will still have a small HID logo and reference number printed in the lower left-hand on the back of the card.
³ The Printed card number is placed in the bottom right-hand corner for UHF
⁴ For Laser Engraved Printed numbers, consult factory for lead times and cost.
⁵ Number of bits should remain below 120 bits

* The composite construction is recommended for all cards with over-laminate applied. Consult with the printer manufacturer prior to ordering.



UHF + iCLASS Card - 601

The SIO enabled UHF/iCLASS smart card provides a secure long range parking and gate control solution that can be used in conjunction with existing access control technologies. Personalize the card with a photo ID, magnetic stripe, barcode, or anti-counterfeiting element. **Direct to Card printing on these cards is not recommended.**

Ensure each required option has been checked with the appropriate choice to fulfill a completed order form.

Base Model 601 Composite 40% Polyester / PVC *

iCLASS Memory Size and Allocation

- 3 - 32k Bits (4K Bytes) Application areas 16k/2+16k/1
- 4 - 32k Bits (4K Bytes) Application areas 16k/16+16k/1

Card Programming

- S - UHF Programmed with Secure Identity Object. iCLASS programmed with standard iCLASS Access Control Application and SIO payloads.
- T - UHF Programmed with Secure Identity Object. iCLASS programmed with Secure Identity Object.
- H - UHF Programmed with Secure Identity Object. iCLASS programmed with standard iCLASS Access Control Application payload.
- C - UHF Programmed with Secure Identity Object. iCLASS field encoded, for use with iCLASS SE Encoder.

Front Packaging (Select one option)

- G - Plain White with Gloss Finish
- C - Custom Artwork with Gloss Finish - Specify Custom Artwork Number¹

Back Packaging (Select one option)

- G - Plain White with Gloss Finish²
- C - Custom Artwork with Gloss Finish - Specify Custom Artwork Number¹
- 1 - Plain White with Gloss Finish with Magnetic Stripe²
- 3 - Custom Artwork with Gloss Finish with Magnetic Stripe - Specify Custom Artwork Number¹

UHF Card Numbering³ (Select one option)

- N - No Printed Card Numbering
- A - Sequential Matching Encoded/Printed (Laser Engraved)⁴
- B - Sequential Encoded/Sequential Non-Matching Printed (Laser Engraved)⁴
- C - Random Encoded/Non-Matching Sequential Printed (Laser Engraved)⁴

iCLASS Card Numbering³ (Select one option)

- N - No Printed Card Numbering
- A - Sequential Matching Encoded/Printed (Laser Engraved)⁴
- B - Sequential Encoded/Sequential Non-Matching Printed (Laser Engraved)⁴
- C - Random Encoded/Non-Matching Sequential Printed (Laser Engraved)⁴

Slot Punch

- N - No Slot Punch

Option - Custom Artwork¹

- _____ (Specify Artwork Number - Refer to the Custom Artwork Forms for new artwork)

Enter your final card options from the above selections. Example: 6013TGGNNN

Final Part Number	601							N	(Options #)
--------------------------	------------	--	--	--	--	--	--	----------	--------------------

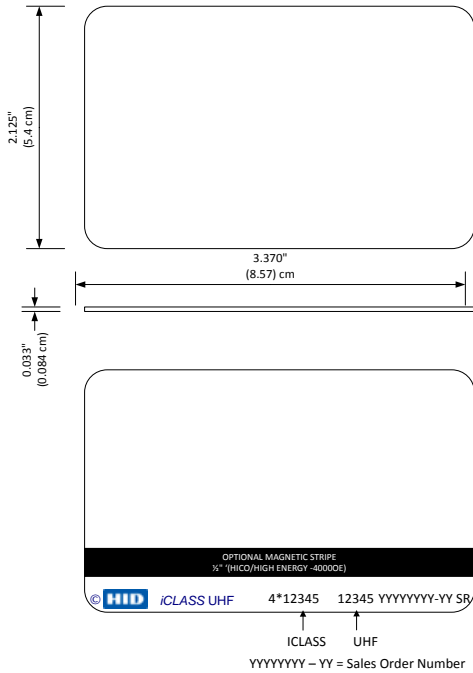

UHF Programming Information

Format Number _____ (example: H10301) Bit Numbers⁵ _____ (example: 26 bit) Facility Code _____
 Encoded Card # Start _____ Stop _____ Printed Card # Start _____ Stop _____
 HID Elite ICE Number (if applicable) - _____ (Custom Format) Site Code _____ City Code _____ OEM Code _____
 Special Instructions: _____



iCLASS Programming Information

Format Number ____ (example: H10301) Bit Numbers ____ (example: 26 bit) Facility Code ____

Encoded Card # Start ____ Stop ____ Printed Card # Start ____ Stop ____

HID Elite ICE Number (if applicable) - ____ (Custom Format) Site Code ____ City Code ____ OEM Code ____

PIN (2-12 digits) : Sequential: Start # _____ Random: Length _____.

Special Instructions: _____

¹ For new artwork files, contact Customer Service for custom artwork number, lead-times, and cost.

² Cards ordered with plain white front and back packaging, or custom artwork, will still have a small HID logo  and reference number printed in the lower left-hand on the back of the card.

³ The Printed card number is placed in the bottom right-hand corner for UHF

⁴ For Laser Engraved Printed numbers, consult factory for lead times and cost.

⁵ Number of bits should remain below 120 bits

* The composite construction is recommended for all cards with over-laminate applied. Consult with the printer manufacturer prior to ordering.



UHF + MIFARE Classic Card - 603

The SIO enabled UHF/MIFARE Classic smart card provides a secure long range parking and gate control solution that can be used in conjunction with existing access control technologies. Personalize the card with a photo ID, magnetic stripe, barcode, or anti-counterfeiting element. **Direct to Card printing on these cards is not recommended.**

Ensure each required option has been checked with the appropriate choice to fulfill a completed order form.

Base Model 603 Composite 40% Polyester / PVC *

Card Programming

- J - UHF Programmed with Secure Identity Object. MIFARE programmed with Secure Identity Object.
- P - UHF Programmed with Secure Identity Object. MIFARE non-programmed.
- H - UHF Programmed with Secure Identity Object. MIFARE programmed with HID MIFARE Access Control Application payload.
- K - UHF Programmed with Secure Identity Object. MIFARE custom programmed (custom part suffix required)

MIFARE Memory Size and Allocation

- M - 4K Bytes

Front Packaging (Select one option)

- G - Plain White with Gloss Finish
- C - Custom Artwork with Gloss Finish - Specify Custom Artwork Number¹

Back Packaging (Select one option)

- G - Plain White with Gloss Finish²
- C - Custom Artwork with Gloss Finish - Specify Custom Artwork Number¹
- 1 - Plain White with Gloss Finish with Magnetic Stripe²
- 3 - Custom Artwork with Gloss Finish with Magnetic Stripe - Specify Custom Artwork Number¹

UHF Card Numbering³ (Select one option)

- N - No Printed Card Numbering
- A - Sequential Matching Encoded/Printed (Laser Engraved)⁴
- B - Sequential Encoded/Sequential Non-Matching Printed (Laser Engraved)⁴
- C - Random Encoded/Non-Matching Sequential Printed (Laser Engraved)⁴

MIFARE Card Numbering³ (Select one option)

- N - No Printed Card Numbering
- A - Sequential Matching Encoded/Printed (Laser Engraved)⁴
- C - Random Encoded/Non-Matching Sequential Printed (Laser Engraved)⁴
- B - Sequential Encoded/Sequential Non-Matching Printed (Laser Engraved)⁴

Slot Punch

- N - No Slot Punch

Option - Custom Artwork¹

_____ (Specify Artwork Number - Refer to the Custom Artwork Forms for new artwork)

Enter your final card options from the above selections. Example: 603JMGGANA

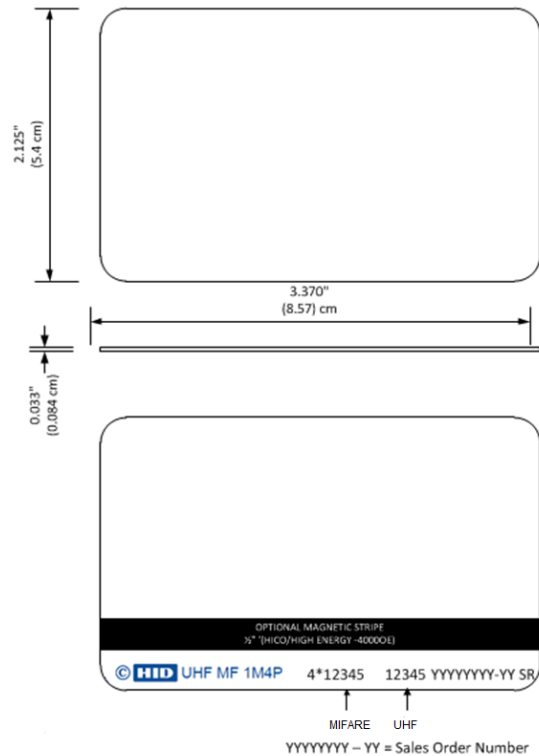

Final Part Number	603							N		(Options #)
-------------------	-----	--	--	--	--	--	--	---	--	-------------



UHF Programming Information

Format Number ____ (example: H10301) Bit Numbers⁵ ____ (example: 26 bit) Facility Code ____
Encoded Card # Start ____ Stop ____ Printed Card # Start ____ Stop ____
HID Elite ICE Number (if applicable) - ____ (Custom Format) Site Code ____ City Code ____ OEM Code ____
Special Instructions: ____

MIFARE Programming Information

Format Number ____ (example: H10301) Bit Numbers ____ (example: 26 bit) Facility Code ____
Encoded Card # Start ____ Stop ____ Printed Card # Start ____ Stop ____
HID Elite ICE Number (if applicable) - ____ (Custom Format) Site Code ____ City Code ____ OEM Code ____
Special Instructions: ____

¹ For new artwork files, contact Customer Service for custom artwork number, lead-times, and cost.

² Cards ordered with plain white front and back packaging, or custom artwork, will still have a small HID logo  and reference number printed in the lower left-hand on the back of the card.

³ The Printed card number is placed in the bottom right-hand corner for UHF

⁴ Inkjetted option not available for these cards

⁵ Number of bits should remain below 120 bits

* The composite construction is recommended for all cards with over-laminate applied. Consult with the printer manufacturer prior to ordering.



HID Proximity Credentials

ProxCard II Card - 1326

Ensure each required option has been checked with the appropriate choice to fulfill a completed order form.

1326 Base Model

Programming (Select one option)

- L - Programmed, Low Frequency (125 kHz) HID. Specify Programming Information.
- N - Non-Programmed, Low Frequency (125 kHz). Programming Information Not Required.

Front Packaging (Select one option)

- S - ProxCard II Artwork - Vinyl with Matte Finish
- M - Plain White Vinyl with Matte Finish
- G - Plain White PVC with Gloss Finish
- C - Custom Artwork - Specify Custom Artwork Number¹

Back Packaging (Select one option)

- S - Base with Molded HID Logo
- C - Custom Artwork - Specify Custom Artwork Number¹

Card Numbering² (Select one option)

- M - Sequential Matching Encoded/Printed (Inkjetted)
- N - No Printed Card Numbering
- S - Sequential Encoded/Sequential Non-Matching Printed (Inkjetted)
- R - Random Encoded/Non-Matching Sequential Printed (Inkjetted)

Slot Punch

- V - Vertical Slot Punch

Option - Custom Artwork²

- _____ (Specify Artwork Number - Refer to the Custom Artwork Forms for new Artwork)

Enter your final card options from check boxes above. Example: 1326LSSMV

Final Part Number	1326				V	-	(Options #)
--------------------------	-------------	--	--	--	----------	----------	--------------------

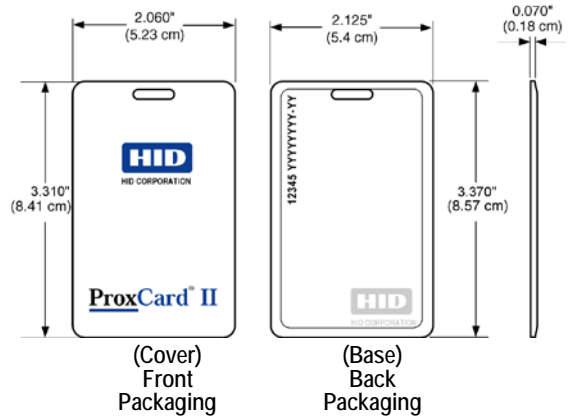

12345 = Card ID Number
 YYYYYYYY-YY = Sales Order Number

125 kHz Card Programming Information

Format Number _____ (example: H10301) Bit Numbers _____ (example: 26 bit) Facility Code _____
 Encoded Card # Start _____ Stop _____ Printed Card # Start _____ Stop _____
 HID Elite ICE Number (if applicable) - _____ (Custom Format) Site Code _____ City Code _____ OEM Code _____
 Special Instructions: _____

¹ For new artwork files, contact Customer Service for custom artwork number, lead-times, and cost.
² The Printed card number is placed in the top left-hand corner on the back of the card. HID logo molded into base on back.



ProxKey III Keyfob - 1346

Ensure each required option has been checked with the appropriate choice to fulfill a completed order form.

1346 Base Model

Programming (Select one option)

- L - Programmed, Low Frequency (125 kHz). Specify Programming Information.
- N - Non-Programmed, Low Frequency (125 kHz). Programming Information Not Required.

Front Packaging

- N - ProxKey III - Black with grey insert. Includes HID Standard Artwork
- C - ProxKey III - Custom Artwork - Specify Custom Artwork Number¹

Back Packaging

- S - Standard

Keyfob Numbering² (Select one option)

- M - Sequential Matching Encoded/Printed (Inkjetted)
- N - No Printed Card Numbering
- S - Sequential Encoded/Sequential Non-Matching Printed (Inkjetted)
- R - Random Encoded/Non-Matching Sequential Printed (Inkjetted)
- A - Sequential Matching Encoded/Printed (Engraved)³
- B - Sequential Encoded/Sequential Non-Matching Printed (Engraved)³
- C - Random Encoded/Non-Matching Sequential Printed (Engraved)³

Additional Options⁴

- N - No Option

Enter your final ProxKey options from check boxes above. Example: 1346LNSMN

Final Part Number	1346			S		N
--------------------------	-------------	--	--	----------	--	----------

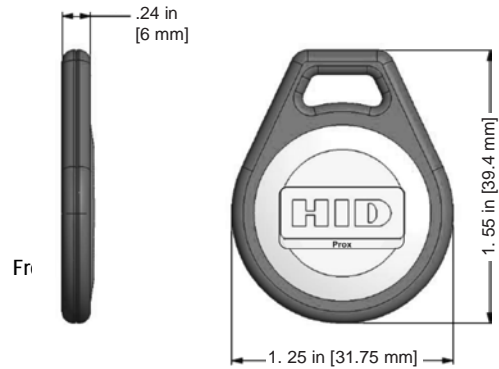

Shown - Front Packaging Option "N"
 12345 = Keyfob ID Number
 YYYYYYYY-YY = Sales Order Number

125 kHz ProxKey Programming Information

Format Number ____ (example: H10301) Bit Numbers ____ (example: 26 bit) Facility Code ____
 Encoded Card # Start ____ Stop ____ Printed Card # Start ____ Stop ____
 HID Elite ICE Number (if applicable) - ____ (Custom Format) Site Code ____ City Code ____ OEM Code ____
 Special Instructions: ____

¹ For new artwork files, contact Customer Service for custom artwork number, lead-times, and cost.
² The Printed number is placed on the back of the Keyfob.
³ For Laser Engraved Printed numbers, consult factory for lead times and cost.
⁴ Key Ring sold separately (Part Number: 57-0001-02)

ISOProx® II Card - 1386 / 1586

Ensure each required option has been checked with the appropriate choice to fulfill a completed order form.

Base Model 1386 Standard PVC 1586 Composite 40% Polyester / PVC *

125 KHz Programming (Select one option)

- L - Programmed. Specify Programming Information.
- N - Unprogrammed, for use with iCLASS SE Encoder. Programming Information Not Required.

Front Packaging (Select one option)

- G - Plain White PVC w/ Gloss Finish
- C - Custom Artwork w/ Gloss Finish - Specify Custom Artwork Number¹

Back Packaging (Select one option)

- G - Plain White PVC w/ Gloss Finish²
- C - Custom Artwork w/ Gloss Finish - Specify Custom Artwork Number^{1, 2}

Card Numbering (Select one option)

- M - Sequential Matching Encoded/Printed (Inkjetted)⁵
- N - No Printed Card Numbering
- S - Sequential Encoded/Sequential Non-Matching Printed (Inkjetted)⁵
- R - Random Encoded/Non-Matching Sequential Printed (Inkjetted)⁵
- A - Sequential Matching Encoded/Printed (Engraved)⁶
- B - Sequential Encoded/Sequential Non-Matching Printed (Engraved)⁶
- C - Random Encoded/Non-Matching Sequential Printed (Engraved)⁶

Slot Punch⁴ (Select one option)

- N - No slot punch, Printed Vertical and Horizontal Slot Indicators
- V - Vertical Slot Punch, Printed Horizontal Slot Indicators
- H - Horizontal Slot Punch, Printed Vertical Slot Indicators

Option - Custom Artwork¹

_____ (Specify Artwork Number - Refer to the Custom Artwork Forms for new Artwork)

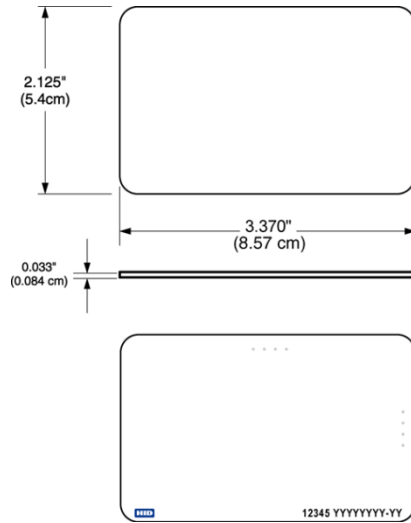

12345 = Card ID Number
 YYYYYYYY-YY = Sales Order Number

Enter your final card options from check boxes above. Example: 1386LGGMN

Final Part Number										-	(Options #)
--------------------------	--	--	--	--	--	--	--	--	--	---	--------------------

125 kHz Card Programming Information

Format Number ____ (example: H10301) Bit Numbers ____ (example: 26 bit) Facility Code ____
 Encoded Card # Start ____ Stop ____ Printed Card # Start ____ Stop ____
 HID Elite ICE Number (if applicable) - ____ (Custom Format) Site Code ____ City Code ____ OEM Code ____
 Special Instructions: ____

¹ For new artwork files, contact Customer Service for custom artwork number, lead-times, and cost.
² Cards ordered with plain white front and back packaging, with no HID artwork or with custom artwork, will still have a small "HID logo" and reference number printed in the lower left-hand corner and a slot punch target printed on the back of the card.
³ The Printed card number is placed in the bottom right-hand corner on the back of the card.
⁴ Cards are provided with an optional slot punch at no additional charge. Some video imaging printers cannot accommodate pre-slot punched cards. Consult with the printer manufacturer prior to ordering.
⁵ Please note that cards shipped within North America are always laser-engraved. Inkjetted option is not available for these cards.
⁶ For Laser Engraved Printed numbers, consult factory for lead times and cost.
 * The composite construction is recommended for all cards that will have an over-laminate applied.



ProxPass® II Vehicle Identification Tag - 1351

Ensure each required option has been checked with the appropriate choice to fulfill a completed order form.

1351 Base Model

Programming¹

L - Programmed, Low Frequency (125 kHz). Specify Programming Information.

Color

B - Standard beige finish

Back Packaging

S - Standard HID logo

Tag Numbering (Select one option)

- M - Sequential Matching Encoded/Printed (Inkjetted)
- N - No Printed Card Numbering
- S - Sequential Encoded/Sequential Non-Matching Printed (Inkjetted)
- R - Random Encoded/Non-Matching Sequential Printed (Inkjetted)

Hardware Option

N - None

Enter your final Tag options from check boxes above. Example: 1351LBSMN

Final Part Number	1351	L	B	S	N	-	(Optional Artwork #)
--------------------------	-------------	----------	----------	----------	----------	----------	-----------------------------

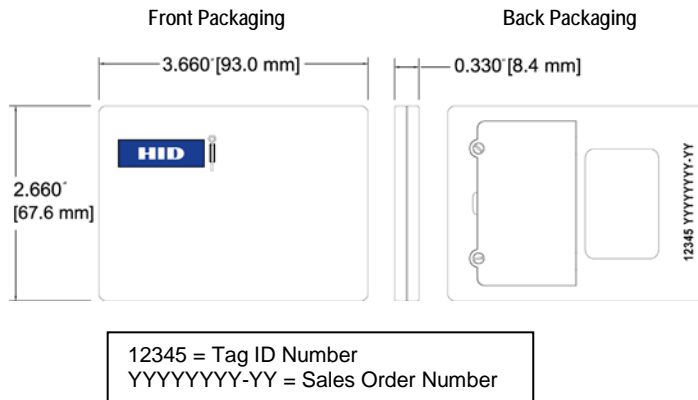

125 kHz Tag Programming Information

Format Number ____ (example: H10301) Bit Numbers ____ (example: 26 bit [maximum of 37-bits]) Facility Code ____
 Encoded Card # Start ____ Stop ____ Printed Card # Start ____ Stop ____
 HID Elite ICE Number (if applicable) - ____ (Custom Format) Site Code ____ City Code ____ OEM Code ____
 Special Instructions: ____

¹The ProxPass II does not support formats longer than 37-bits (including 48-bit Corporate 1000)

The ProxPass II Tag includes two replaceable Encoded batteries and Velcro strips for a complete and simple installation.

Battery Part # BR2330 is available at most electronic stores (not sold by HID).

MicroProx® Tag Proximity - 1391

Ensure each required option has been checked with the appropriate choice to fulfill a completed order form.

1391 Base Model

Programming (Select one option)

- L - Programmed, Low Frequency (125 kHz). Specify Programming Information.
- N - Non-Programmed, Low Frequency (125 kHz). Programming Information Not Required.

Front Packaging (Select one option)

- S - Gray with HID Standard Artwork
- G - Plain Gray Finish, (No Artwork)
- C - Custom Artwork - Specify Custom Artwork Number¹

Back Packaging³

- S - Adhesive Backing

Tag Numbering² (Select one option)

- M - Sequential Matching Encoded/Printed (Inkjetted)
- N - No Printed Tag Numbering
- S - Sequential Encoded/Sequential Non-Matching Printed (Inkjetted)
- R - Random Encoded/Non-Matching Sequential Printed (Inkjetted)

Slot Punch

- N - None

Optional Custom Artwork¹

_____ (Specify Artwork Number - Refer to the Custom Artwork Forms for new Artwork)

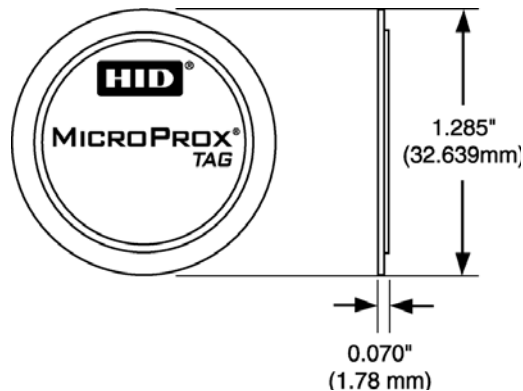

Enter your final Tag options from check boxes above. Example: 1391LKSMN

Final Part Number	1391				S		N	-	(Optional Artwork #)
--------------------------	-------------	--	--	--	----------	--	----------	---	-----------------------------

125 kHz Tag Programming Information

Format Number ____ (example: H10301) Bit Numbers ____ (example: 26 bit) Facility Code ____
 Encoded Card # Start ____ Stop ____ Printed Card # Start ____ Stop ____
 HID Elite ICE Number (if applicable) - ____ (Custom Format) Site Code ____ City Code ____ OEM Code ____
 Special Instructions: ____

¹ For new artwork files, contact Customer Service for custom artwork number, lead-times, minimum order quantities, and cost.
² The Printed tag number is placed on the back of the tag.
³ The MicroProx Tag is not for use on cards that use full insertion or tractor feed type readers.
 Do not adhere to metal surfaces. Metal shields the RF, making the tag inoperable. Due to variations in cards and reading devices, HID does not claim that the MicroProx Tag will work in every situation. Functional and non-functional MicroProx Tags are available for compatibility testing with existing credential and reader technologies. Compatibility should be confirmed prior to ordering.

MicroProx Placement

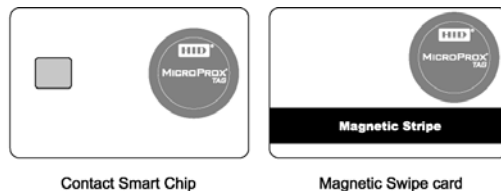

Direct Image PVC Glossy Label Part Numbers

Part #	Description	Thickness	Dimensions
1324GAV11	ProxCard II size with slot punch, white adhesive back	10 mil PVC	3.310" x 2.060"
1324GAN11	ProxCard II size, no slot punch, white adhesive back	10 mil PVC	3.310" x 2.060"
1324GAV21	ProxCard II size with slot punch, white adhesive back	20 mil PVC	3.310" x 2.060"
1324GAN21	ProxCard II size, no slot punch, white adhesive back	20 mil PVC	3.310" x 2.060"
1324GBV22	ISOProx II and ProxCard II size with slot punch, brown (3M) adhesive back	20 mil PVC	3.370" x 2.125"
1324GBN22	ISOProx II and ProxCard II size, no slot punch, brown (3M) adhesive back	20 mil PVC	3.370" x 2.125"
1324GAV22	ISOProx II and ProxCard II size, with slot punch, white adhesive back	20 mil PVC	3.370" x 2.125"
1324GAN22	ISOProx II and ProxCard II size, no slot punch, white adhesive back	20 mil PVC	3.370" x 2.125"

Notes:

- Some dye sublimation printers cannot accommodate pre-slot punched labels; consult with the printer manufacturer prior to ordering.
- Labels are packaged in multiples of 100 pieces. Minimum order quantity is 100 pieces. Orders will be accepted in multiples of 100 pieces per label Model.
- Make sure to adjust your dye sublimation printer setting to the proper PVC label thickness and dimension.

Indala 125kHz Credential

Every part number consists of a base model number to indicate the type of product, and a letter or number to indicate each product option. Each Indala product has a standard part number that includes default options, as indicated on the order guide. When an order is placed for a product, the base model number and all options must be specified. If you require any options that are different from the default options, you must also indicate those options at the time the order is placed. All part numbers must be complete to be accepted by HID's order entry system.

All card orders must have the following information:

- **BASE MODEL NUMBER** - Specifies card or type
- **PROGRAMMING** - Specifies if card is factory or field programmed (**format or format number, facility code, and ID number range must be given at time of order**)
- **FRONT or FLAT SIDE GRAPHICS** - Specifies standard or custom artwork, and smart chip placement
- **BACK or EMBOSSED SIDE GRAPHICS** - Specifies standard or custom artwork, and smart chip placement
- **MARKING POSITION** - Specifies location of card marking.

Note: Card marking is surface printed and, therefore is not to be considered permanent. In certain cases Laser etching may be used instead of inkjet marking. Laser etching is permanent marking but is not used on all products.

- **SLOT PUNCH** - Specifies slot location if available
- **CARD OPTIONS** - Applies to FlexCard® (Base Model FPCRD/CXCRD) only
- **MAGNETIC STRIPE OPTION** - Specifies if card is to have a magstripe and which type (ISO Imageable Cards only)
- **CUSTOM FILE NUMBER** - Specifies the artwork number to be used

FPISO - FlexPass Imageable Card

Standard Part No.: FPISO-SSSCNA-0000

Description: 125 kHz, white glossy finish front, white glossy finish with Indala logo back, marking on standard location, no slot punch, no magstripe, no artwork

FPISO S S S C N A 0000

BASE MODEL NUMBERS

PROGRAMMING

FRONT GRAPHICS

BACK GRAPHICS

MARKING POSITION

SLOT PUNCH

MAGNETIC STRIPE OPTION

CUSTOM FILE NO

BASE MODEL NUMBERS

- FPISO** FlexISO® Proximity Card
- FPWGD** FlexISO Proximity and Wiegand Combination Card
- FPIXT** FlexISO XT Composite Proximity Card

PROGRAMMING

- S** = Standard, Programmed, Low Frequency 125 kHz - exact coding standard, with no gaps or over-runs
(Specify Format Number, Facility Code, and ID Range)
- N** = Not Programmed, Low Frequency 125 kHz (Blank/Programmable)

FRONT GRAPHICS

- S** = Standard white glossy finish, suitable for video imaging
- C** = Custom (Artwork on file or new)

BACK GRAPHICS

- S** = Standard white glossy finish with Indala logo, card marking (Sales Order & matching internal ID number), suitable for dye sublimation imaging in most areas
- C** = Custom (Artwork on file or new)

MARKING POSITION

Note: Standard Marking is Label Code E153, which is Sales Order number & matching 5 digit internal ID number, is used unless otherwise specified.

C = Position 3/Standard Location (Back Side/Lower Right Corner)

Note: Inkjet marking is surface printed and, therefore is not to be considered permanent.

In some cases Laser etching will replace inkjet marking. Laser etching is permanent in most applications.

SLOT PUNCH

- N** = None
- V** = Vertical (portrait orientation) - Unavailable for FPWGD
- H** = Horizontal (landscape orientation)

MAGNETIC STRIPE OPTION

- A** = No Magstripe
- B** = Standard Magstripe (3-track, high coercivity, 4000 oersted)

CUSTOM FILE NUMBER (4 Characters - Factory Assigned)

0000 = No Artwork (Call your Customer Service Representative for new artwork)

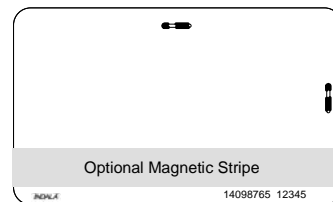

Position C



FPCRD - FlexCard Standard Card

Standard Part No.: FPCRD-SSSMW-0000

Description: 125 kHz, printed Indala logo on front, embossed Indala logo on back, card marking on flat side (lower right corner with slot to the right), white color (not printable), no artwork. Vertical slot punch only.

FPCRD S S S M W 0000

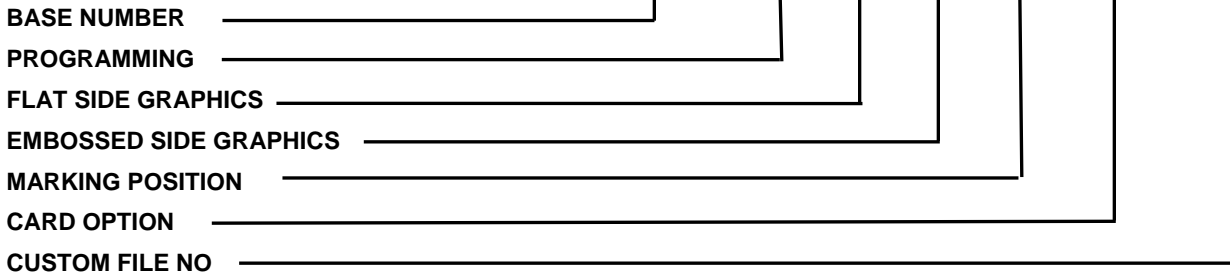

BASE NUMBER

FPCRD - 125 kHz Clamshell type Proximity Card

PROGRAMMING

S = Standard, Programmed, Low Frequency 125 kHz - exact coding standard, with no gaps or over-runs

(Specify Format or Format Number, Facility Code, and ID Range)

N = Not Programmed, Low Frequency 125 kHz (Blank/Programmable)

FLAT SIDE GRAPHICS

S = Standard (Flat Side with printed Indala logo)

C = Custom (Artwork on file or new)

EMBOSSED SIDE GRAPHICS

S = Standard (Embossed Side with embossed Indala logo)

C = Custom (Artwork on file or new, still with embossed Indala logo)

MARKING POSITION

Notes:

- Standard Marking or Label Code E153, which is Sales Order number & matching internal ID number, is used unless otherwise specified.
- Inkjet marking is surface printed and, therefore is not to be considered permanent. In some cases Laser etching will replace inkjet marking. Laser etching is permanent in most applications.

A = Position 1/Flat Side (with slot punch to the right, lower left corner) - available with Printable Option only

C = Position 3/Flat Side (with slot punch to the right, lower right corner) - available with Printable Option only

K = Position 1/Embossed Side (with slot punch to the right, lower left corner)

M = (Standard) = Position 3/Embossed Side (with slot punch to the right, lower right corner)

CARD OPTION

W = White (standard color) - surface treated with UV protection - may not accept printing

P = Printable, matt finish - No varnish, no logo, surface will accept post printing

CUSTOM FILE NUMBER (4 Characters - Factory Assigned)

0000 = No Artwork

Call your Customer Service Representative for artwork

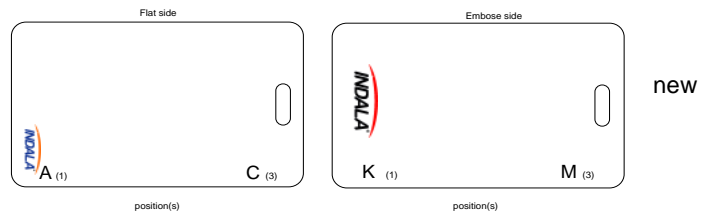

new

FPTAG - FlexTag

Standard Part No.: FPTAG-SSSS-XXXX

Description: 125 kHz, printed Indala logo on front side

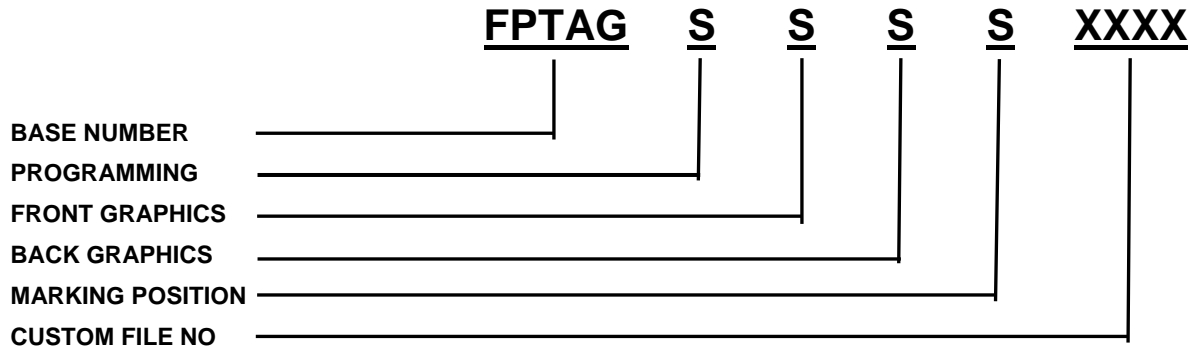

BASE NUMBER

FPTAG - 125 kHz Keytag Type Proximity Card

PROGRAMMING

S = Standard Programmed, Low Frequency 125 kHz - exact coding standard, with no gaps or over-runs.

(Specify Format or Format Number, Facility Code, and ID Range)

N = Not Programmed

FRONT GRAPHICS

S = Standard (printed Indala logo)

BACK GRAPHICS

S = Standard (no logo, printed strip for marking)

MARKING POSITION

Notes:

- Standard Marking or Label Code E201, which is a shortened version of the Sales Order number & matching internal ID number, is used unless otherwise specified.
- Inkjet marking is surface printed and, therefore is not to be considered permanent. Most Keytag marking will be with Laser etching which is permanent in most applications.

S = Standard (back side on printed strip)

CUSTOM FILE NUMBER XXXX (4 Characters - Factory Assigned)

0002 = No Artwork

AAAA = Custom Artwork. Contact your Customer Service Representative for new artwork.

FPKEY - FlexKey Keytag

Standard Part No.: FPKEY-SSSS-0000

Description: 125 kHz, printed Indala logo on front side, printed strip for marking on back side

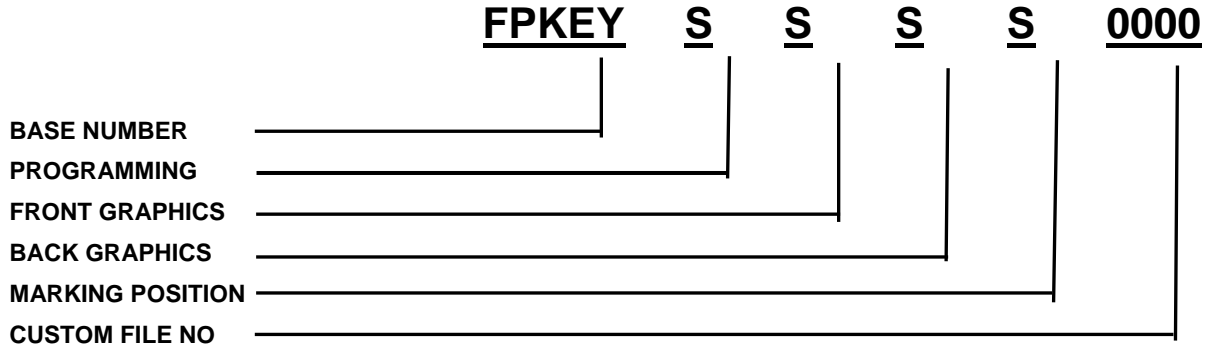

BASE NUMBER

FPKEY - 125 kHz Keytag Type Proximity Card

PROGRAMMING

S = Standard, Programmed, Low Frequency 125 kHz - exact coding standard, with no gaps or over-runs
 (*Specify Format or Format Number, Facility Code, and ID Range*)

N = Not Programmed, Low Frequency 125 kHz (Blank/Programmable)

FRONT GRAPHICS

S = Standard (printed Indala logo)
C = Custom (Artwork on file or new)

BACK GRAPHICS

S = Standard (no logo, printed strip for marking)
C = Custom (Artwork on file or new)

MARKING POSITION

Notes:

- Standard Marking or Label Code E201, which is a shortened version of the Sales Order number & matching internal ID number, is used unless otherwise specified.
- Inkjet marking is surface printed and, therefore is not to be considered permanent. Most Keytag marking will be with Laser etching which is permanent in most applications.

S = Standard (back side on printed strip)

CUSTOM FILE NUMBER (4 Characters - Factory Assigned)

0000 = No Artwork

Call your Customer Service Representative for new artwork.

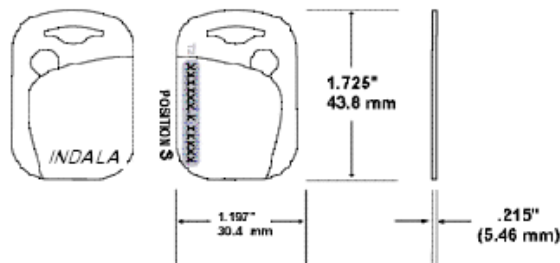

FlexPass Formats

The following formats are non-proprietary and are available to all customers. Call HID to discuss other formats.

Format Name: 26-BIT WIEGAND

Card Format Number	Facility Code Range	ID Number Range
40134	0 to 255	0 to 65,535 (Systems installed prior to June 2003)
ASP 10022	0 to 255	0 to 65,535 (All new Systems except FP Lite)

Reader Format Numbers

10022 (1L = 1x Wire for LED control)
 10200 (2L = 2x Wires for LED control)

Format Name: 27-BIT INDALA

Card Format Number	Facility Code Range	ID Number Range
4010X	0 to 8,191	0 to 16,383

Reader Format Numbers

10251 (1L = 1x Wire for LED control)
 1026X (2L = 2x Wires for LED control)

Format Name: ABA TRACK 2

Card Format Numbers	Facility Code Range	ID Number Range
4038X (ASP)	0 to 255	0 to 99,999
17256 (ASP+)	0 to 99,999	0 to 99,999

Reader Format Numbers

11037 OC (Open Collector)
 11738 PUR (Pull Up Resistor)

Format Name: RS232 Serial Data

Card Format Number	Card Programming Range
16144	up to 24 characters in total length, i.e. ABCD12345678901234567890

Reader Format Number

16144

Format Options for FP506B/FP507B Proximity & Keypad Readers (e.g. Format 10022K01)

CFG. Number	Buf/Unbuf	Data Type	Options	Pin Size	Special Keys	Emulates
K01	UnBuffered	8-bit burst			*/# keys enabled	ARK-501
K02	UnBuffered	8-bit burst			*/# keys disabled	
K03	Buffered	Wiegand	facility code xx		*/# keys enabled	
K04	Buffered	Wiegand	facility code xx		*/# keys disabled	
K05	Buffered	Magstripe	LSB First	4 digit PIN	*/# keys enabled	ARK-501 BUFFERED
K06	Buffered	Magstripe	LSB First	4 digit PIN	*/# keys disabled	ARK-501 BUFFERED PINKERTON
K07	Buffered	Magstripe	LSB First	5 digit PIN	*/# keys enabled	
K08	Buffered	Magstripe	LSB First	5 digit PIN	*/# keys disabled	
K09	Buffered	Magstripe	MSB First	4 digit PIN	*/# keys enabled	
K10	Buffered	Magstripe	MSB First	4 digit PIN	*/# keys disabled	
K11	Buffered	Magstripe	MSB First	5 digit PIN	*/# keys enabled	
K12	Buffered	Magstripe	MSB First	5 digit PIN	*/# keys disabled	
K13	Unbuffered	4 bit burst			*/# keys enabled	
K14	Unbuffered	4 bit burst			*/# keys disabled	



13.56 MHz Card Programming Information

Format Number ____ (example: H10301) Bit Numbers ____ (example: 26 bit) Facility Code ____

Encoded Card # Start ____ Stop ____ Printed Card # Start ____ Stop ____

HID Elite ICE Number (if applicable) - ____ (Custom Format) Site Code ____ City Code ____ OEM Code ____

Special Instructions: ____

For Contact Smart Chip selection, refer to Logical Access How to Order Guide. Standard configuration does not include a contact smart chip module.¹ For new artwork files, contact Customer Service for custom artwork number, lead-times, and cost.² Cards ordered with plain white front and back packaging, with no HID artwork or with custom artwork, will still have a small HID logo  and reference number printed in the lower left-hand corner and a slot punch target printed on the back of the card.³ The Printed card number is placed in the bottom right-hand corner on the back of the card on Proximity Format Programming only.⁴ For Laser Engraved Printed numbers, consult factory for lead times and cost. When printed, by default the number is encoded MSB (most significant byte) -> LSB (least significant byte).⁵ Cards are provided with an optional slot punch at no additional charge. Some video imaging printers cannot accommodate pre-slot punched cards. Consult with the printer manufacturer prior to ordering.⁶ Includes a permanent Unique MIFARE 32 Bit Serial number. When printed the number is encoded MSB (most significant byte) -> LSB (least significant byte).⁷ Please note that cards shipped within North America are always laser-engraved. Inkjetted option is not available for these cards.

* The composite construction is recommended for all cards with over-laminate applied.



MIFARE Classic + Prox card - 350 / 355 / 1431 / 1441 / 1437 / 1447

Encompasses the industry's broadest range of open standard contactless smart card products. Provides the memory structure and capacity to store multiple applications on a single credential with the addition of Proximity technology for easier migration. All MIFARE Classic + Prox cards can be ordered with or without SIO encoding.

Ensure each required option has been checked with the appropriate choice to fulfill a completed order form.

MIFARE Classic + Prox card with SIO encoding (Recommended)

- 3500 (1K) Standard PVC
- 3506 (4K) Standard PVC
- 3550 (1K) Composite 40% Polyester/PVC*
- 3556 (4K) Composite 40% Polyester/PVC*

Programming (Select one option)

- P - Programmed with Security Identity Object (SIO) for MIFARE
- R - Both interfaces programmed (MIFARE with Security Identity Object (SIO), Prox programmed with HID format)

OR MIFARE Classic + Prox card without SIO encoding

- 1431 (1K) Standard PVC
- 1441 (4K) Standard PVC
- 1437 (1K) Composite 40% Polyester / PVC*
- 1447 (4K) Composite 40% Polyester / PVC*

Programming (Select one option)

- L - Programmed, (125 kHz only with HID Format)⁶. Specify Programming Information.
- M - Programmed, HID MIFARE ⁶ (Specify HID format, for example H10301).
- B - Programmed, (125kHz and 13.56 MHz with HID Format)⁶. Specify Programming Information.
- N - Non-Programmed (125 kHz & 13.56 MHz without HID Format)⁶. Programming Information Not Required.
- S - Custom Programmed, (13.56 MHz only)⁶, Prox configured. Specify Programming Information
- B - Programmed, (125kHz and 13.56 MHz with HID Format)⁶. Specify Programming Information.

Front Packaging (Select one option)

- G - Plain White with Gloss Finish
- C - Custom Artwork with Gloss Finish - Specify Custom Artwork Number¹

Back Packaging (Select one option)

- G - Plain White with Gloss Finish²
- 1 - Plain White with Gloss Finish with Magnetic Stripe²
- C - Custom Artwork with Gloss Finish - Specify Custom Artwork Number^{1, 2}
- 3 - Custom Artwork with Gloss Finish with Magnetic Stripe - Specify Custom Artwork Number^{1, 2}

13.56 MHz MIFARE Card Numbering³ (Select one option)

- M - Sequential Matching Encoded/Printed (Inkjetted)⁵
- N - No Printed Card Numbering
- U - UID (CSN) HEX card numbering only (Inkjetted)⁵
- V - UID (CSN) Decimal card numbering only (Inkjetted)⁵
- S - Sequential Encoded/Sequential Non-Matching Printed (Inkjetted)⁵
- R - Random Encoded/Non-Matching Sequential Printed (Inkjetted)⁵
- A - Sequential Matching Encoded/Printed (Laser Engraved)⁴
- B - Sequential Encoded/Sequential Non-Matching Printed (Laser Engraved)⁴
- C - Random Encoded/Non-Matching Sequential Printed (Laser Engraved)⁴
- Z - Reversed UID (CSN) Decimal card numbering only (Laser Engraved)⁴

Slot Punch (Select one option)

- N - No slot punch. This card can be slotted vertically, Printed Vertical Slot Indicators
- V - Vertical Slot Punch

125 kHz Proximity Card Numbering³ (Select one option)

- M - Sequential Matching Encoded/Printed (Inkjetted)
- N - No Printed Card Numbering
- S - Sequential Encoded/Sequential Non-Matching Printed (Inkjetted)
- R - Random Encoded/Non-Matching Sequential Printed (Inkjetted)
- A - Sequential Matching Encoded/Printed (Engraved)⁴
- B - Sequential Encoded/Sequential Non-Matching Printed (Engraved)⁴
- C - Random Encoded/Non-Matching Sequential Printed (Engraved)⁴

Option - Custom Artwork¹

- _____ (Specify Artwork Number - Refer to the Custom Artwork forms for new artwork)

Enter your final card options from check boxes above. Example: 3506PGGMNS

Final Part Number						N			-	(Options #)
-------------------	--	--	--	--	--	---	--	--	---	-------------

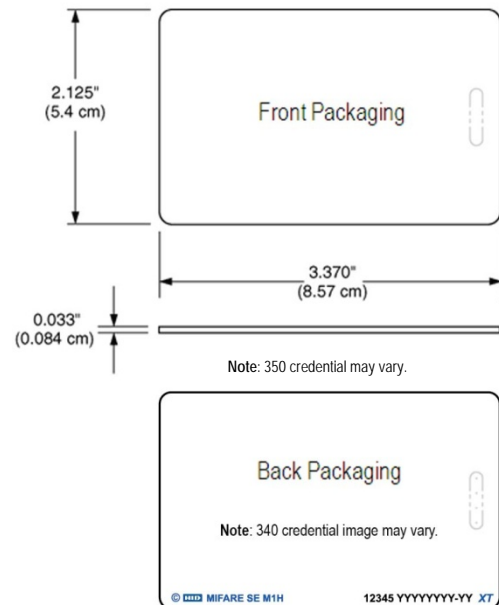



13.56 MHz Card Programming Information

Format Number ____ (example: H10301) Bit Numbers ____ (example: 26 bit) Facility Code ____
Encoded Card # Start ____ Stop ____ Printed Card # Start ____ Stop ____
HID Elite ICE Number (if applicable) - ____ (Custom Format) Site Code ____ City Code ____ OEM Code ____
Special Instructions: ____

125 KHz Card Programming Information

Format Number ____ (example: H10301) Bit Numbers ____ (example: 26 bit) Facility Code ____
Encoded Card # Start ____ Stop ____ Printed Card # Start ____ Stop ____
HID Elite ICE Number (if applicable) - ____ (Custom Format) Site Code ____ City Code ____ OEM Code ____
Special Instructions: ____

For Contact Smart Chip selection, refer to Logical Access How to Order Guide. Standard configuration does not include a contact smart chip module.

¹ For new artwork files, contact Customer Service for custom artwork number, lead-times, and cost.

² Cards ordered with plain white front and back packaging, with no HID artwork or with custom artwork, will still have a small HID logo  and reference number printed in the lower left-hand corner and a slot punch target printed on the back of the card.

³ The Printed card number is placed in the bottom right-hand corner on the back of the card on Proximity Format Programming only.

⁴ For Laser Engraved Printed numbers, consult factory for lead times and cost. When printed, by default the number is encoded MSB (most significant byte) -> LSB (least significant byte).

⁵ Please note that cards shipped within North America are always laser-engraved. Inkjetted option is not available for these cards.

⁶ Includes a permanent Unique MIFARE 32 Bit Serial number.

* The composite construction is recommended for all cards with over-laminate applied.



MIFARE Classic Keyfob - 1434 / 1444

Ensure each required option has been checked with the appropriate choice to fulfill a completed order form.

Base Model 1434 (1K) 1444 (4K)

Programming (Select one option)

- M - Programmed, HID MIFARE⁶ (Specify HID format, for example H10301).
- N - Non-Programmed (13.56 MHz). Programming Information Not Required.
- S - Custom Programmed, Specify Programming Information.

Front Packaging (Select one option)

- S - Standard HID Artwork
- C - Custom Artwork - Specify Custom Artwork Number¹

Back Packaging

- S - Standard



Key Numbering¹ (Select one option)

- M - Sequential Matching Encoded/Printed (Inkjetted)
- N - No Printed Card Numbering
- S - Sequential Encoded/Sequential Non-Matching Printed (Inkjetted)
- R - Random Encoded/Non-Matching Sequential Printed (Inkjetted)
- A - Sequential Matching Encoded/Printed (Laser Engraved)⁴
- B - Sequential Encoded/Sequential Non-Matching Printed (Laser Engraved)⁴
- C - Random Encoded/Non-Matching Sequential Printed (Laser Engraved)⁴

Slot Punch²

- N - None

Enter your final Key options from check boxes above. Example: 1434NSSNN

Final Part Number				S		N
-------------------	--	--	--	---	--	---

13.56 MHz Card Programming Information

Format Number ____ (example: H10301) Bit Numbers ____ (example: 26 bit) Facility Code ____

Encoded Card # Start ____ Stop ____ Printed Card # Start ____ Stop ____

HID Elite ICE Number (if applicable) - ____ (Custom Format) Site Code ____ City Code ____ OEM Code ____

Special Instructions: ____

¹ The Printed key number is placed on the back of the key.

² Key Ring sold separately (Part Number: 57-0001-02).

³ Includes a permanent Unique MIFARE 32 Bit Serial number.

⁴ For Laser Engraved Printed numbers, consult factory for lead times and cost.

MIFARE Classic Adhesive Tag - 1435

Ensure each required option has been checked with the appropriate choice to fulfill a completed order form.

Base Model 1435 (1K)

Programming (Select one option)

- M - Programmed, HID MIFARE 6 (Specify HID format, for example H10301).
- N - Non-Programmed (13.56 MHz). Programming Information Not Required.
- S - Custom Programmed, Specify Programming Information.

Front Packaging (Select one option)

- S - Standard HID Artwork
- C - Custom Artwork - Specify Custom Artwork Number¹

Back Packaging

- S - Standard

Tag Numbering¹ (Select one option)

- M - Sequential Matching Encoded/Printed (Inkjetted)
- N - No Printed Card Numbering
- S - Sequential Encoded/Sequential Non-Matching Printed (Inkjetted)
- R - Random Encoded/Non-Matching Sequential Printed (Inkjetted)

Slot Punch²

- N - None



Enter your final Tag options from check boxes above. Example: 1435NSSNN

Final Part Number				S		N
-------------------	--	--	--	---	--	---

13.56 MHz Card Programming Information

Format Number ____ (example: H10301) Bit Numbers ____ (example: 26 bit) Facility Code ____

Encoded Card # Start ____ Stop ____ Printed Card # Start ____ Stop ____

HID Elite ICE Number (if applicable) - ____ (Custom Format) Site Code ____ City Code ____ OEM Code ____

Special Instructions: ____

¹ The Printed tag number is placed on the back of the tag.

² For new artwork files, contact Customer Service for custom artwork number, lead-times, minimum order quantities, and cost.

³ The Tag is not for use on cards that use full insertion or tractor feed type readers.

⁴ Includes a permanent Unique MIFARE 32 Bit Serial number.

* Up to 1.14in (29mm) read range in free air.

Do not adhere to metal surfaces. Metal shields the RF, making the tag inoperable. Due to variations in cards and reading devices, HID does not claim that the Tag will work in every situation. Functional and non-functional Tags are available for compatibility testing with existing credential and reader technologies. Compatibility should be confirmed prior to ordering.

* = Actual read range performance affected by mounting location, environment and the tags tuned resonant frequency.

MIFARE DESFire EV1 + Prox Card - 380 / 385 / 1451 / 1457

Based on open global standards for security, and is interoperable with existing MIFARE DESFire® infrastructures with the addition of Proximity technology for easier migration. All MIFARE DESFire EV1 cards can be order either with or without SIO encoding.

Ensure each required option has been checked with the appropriate choice to fulfill a completed order form.

Card with SIO encoding + Prox (Recommended)

- 3800 Standard PVC
- 3850 Composite 40% Polyester/PVC*

MIFARE DESFire EV1 Memory Size

- C - 8K Bytes DESFire EV1

Programming (Select one option)

- P - Programmed with Security Identity Object (SIO) for MIFARE DESFire EV1, Prox non-programmed
- R - Both interfaces programmed (MIFARE DESFire EV1 with Security Identity Object (SIO), Prox programmed with HID format)

OR

Card without SIO encoding + Prox

- 1451 Standard PVC
- 1457 Composite 40% Polyester/PVC*

*HITAG based cards are not available with composite

MIFARE DESFire EV1 Memory Size

- C - 8K Bytes DESFire EV1

Programming (Select one option)

- L - Programmed (125KHz only). Specify programming information
- N - Non-Programmed (125KHz & 13.56MHz). Programming information not required.
- S - Custom programming, (13.56 MHz only), Prox Configured Specify Programming Information.
- R - Custom programming, (125kHz and Custom 13.56 MHz), Specify Programming Information.
- F - Non-Programmed (HITAG1 & 13.56 MHz). Programming Information Not Required.
- G - Custom Programmed, (13.56 MHz only), HITAG1 Configured only. Specify Programming Information for MIFARE DESFire EV1.

Front Packaging (Select one option)

- G - Plain White with Gloss Finish
- C - Custom Artwork with Gloss Finish - Specify Custom Artwork Number¹

Back Packaging (Select one option)

- G - Plain White with Gloss Finish²
- 1 - Plain White with Gloss Finish with Magnetic Stripe²
- C - Custom Artwork with Gloss Finish - Specify Custom Artwork Number^{1, 2}
- 3 - Custom Artwork with Gloss Finish with Magnetic Stripe - Specify Custom Artwork Number^{1, 2}

13.56 MHz DESFire Card Numbering³ (Select one option)

- M - Sequential Matching Encoded/Printed (Inkjetted)⁵
- N - No Printed Card Numbering
- S - Sequential Encoded/Sequential Non-Matching Printed (Inkjetted)⁵
- R - Random Encoded/Non-Matching Sequential Printed (Inkjetted)⁵
- A - Sequential Matching Encoded/Printed (Laser Engraved)⁴
- B - Sequential Encoded/Sequential Non-Matching Printed (Laser Engraved)⁴
- C - Random Encoded/Non-Matching Sequential Printed (Laser Engraved)⁴

Slot Punch

IMPORTANT - MIFARE DESFire EV1 + prox credentials do not allow a slot punch due to the antenna design, use a badge holder to attach this card to a lanyard or badge clip.

- N - No Slot Punch

125 KHz Card Numbering³

- M - Sequential Matching Encoded/Printed (Inkjetted)⁵
- N - No Printed Card Numbering
- S - Sequential Encoded/Sequential Non-Matching Printed (Inkjetted)⁵
- R - Random Encoded/Non-Matching Sequential Printed (Inkjetted)⁵
- A - Sequential Matching Encoded/Printed (Laser Engraved)⁴
- B - Sequential Encoded/Sequential Non-Matching Printed (Laser Engraved)⁴
- C - Random Encoded/Non-Matching Sequential Printed (Laser Engraved)⁴

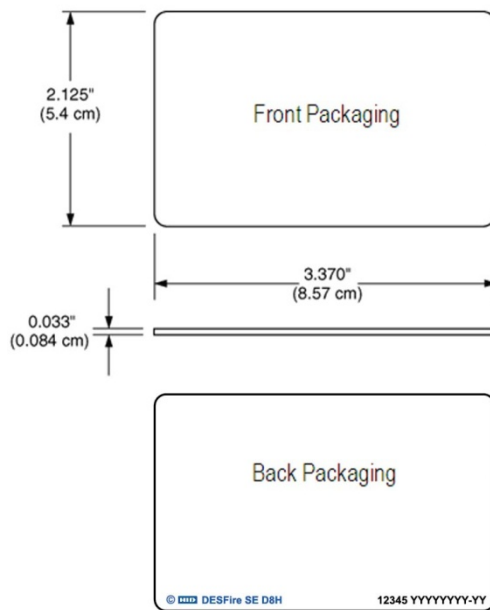

12345 = Card ID Number
 YYYYYYYY-YY = Sales Order Number



Option - Custom Artwork¹

_____ (Specify Artwork Number - Refer to the Custom Artwork Forms for new Artwork)

Enter your final card options from check boxes above. Example: 3850CPGGNNN

Final Part Number		C					N		-	(Options #)
--------------------------	--	----------	--	--	--	--	----------	--	---	--------------------

13.56 MHz Card Programming Information

Format Number _____ (example: H10301) Bit Numbers _____ (example: 26 bit) Facility Code _____

Encoded Card # Start _____ Stop _____ Printed Card # Start _____ Stop _____

HID Elite ICE Number (if applicable) - _____ (Custom Format) Site Code _____ City Code _____ OEM Code _____

Special Instructions: _____

125KHz Card Programming Information

Format Number _____ (example: H10301) Bit Numbers _____ (example: 26 bit) Facility Code _____

Encoded Card # Start _____ Stop _____ Printed Card # Start _____ Stop _____

HID Elite ICE Number (if applicable) - _____ (Custom Format) Site Code _____ City Code _____ OEM Code _____

Special Instructions: _____

For Contact Smart Chip selection, refer to the Logical Access How to Order guide. Standard configuration does not include a contact smart chip module.

¹ For new artwork files, contact Customer Service for custom artwork number, lead-times, and cost.

² Cards ordered with plain white front and back packaging, with no HID artwork or with custom artwork, will still have a small "HID logo"  and reference number printed in the lower left-hand corner and a slot punch target printed on the back of the card.

³ The Printed card number is placed in the bottom left-hand corner (125kHz) and in the bottom right-hand corner (13.56 MHz) on the back of the card on Proximity Programming only. Permanent unique MIFARE DESFire 56 Bit serial # cannot be printed on cards.

⁴ For Laser Engraved Printed numbers, consult factory for lead times and cost.

* The composite construction is recommended for all cards with over-laminate applied

MIFARE Classic + MIFARE DESFire EV1 Card - 282

The MIFARE Classic + MIFARE DESFire EV1 contactless card offers multiple High Frequency technologies to simplify card issuance for diverse systems or migration projects.

Ensure each required option has been checked with the appropriate choice to fulfill a completed order form.

Base Model 282 Composite 40% Polyester / PVC *

MIFARE Classic High Frequency Technology

N - MIFARE Classic 4K Bytes

Card Programming (Select one option)

- B - Programmed MIFARE Classic and MIFARE DESFire EV1 Technology. Specify Programming Information.
- P - MIFARE Classic Programmed only, not MIFARE DESFire EV1 Technology. Specify Programming Information.
- A - Non-Programmed MIFARE Classic. Programmed MIFARE DESFire EV1 Technology. Specify Programming Information.
- N - Non-Programmed MIFARE Classic and MIFARE DESFire EV1.

MIFARE DESFire EV1 High Frequency Technology

K - MIFARE DESFire EV1 8K Bytes

Front Packaging (Select one option)

- G - Plain White with Gloss Finish
- C - Custom Artwork with Gloss Finish - Specify Custom Artwork Number¹

Back Packaging (Select one option)

- G - Plain White with Gloss Finish²
- C - Custom Artwork with Gloss Finish - Specify Custom Artwork Number¹
- 1 - Plain White with Gloss Finish with Magnetic Stripe²
- 3 - Custom Artwork with Gloss Finish with Magnetic Stripe - Specify Custom Artwork Number¹

MIFARE Classic High Frequency Card Numbering³ (Select one option)

- M - Sequential Matching Encoded/Printed (Inkjetted)
- N - No Printed Card Numbering
- S - Sequential Encoded/Sequential Non-Matching Printed (Inkjetted)
- R - Random Encoded/Non-Matching Sequential Printed (Inkjetted)
- A - Sequential Matching Encoded/Printed (Laser Engraved)⁴
- B - Sequential Encoded/Sequential Non-Matching Printed (Laser Engraved)⁴
- C - Random Encoded/Non-Matching Sequential Printed (Laser Engraved)⁴
- U - UID (CSN) HEX card numbering only (Inkjetted)
- V - UID (CSN) Decimal card numbering only (Inkjetted)

Slot Punch

IMPORTANT - Dual High Frequency credentials do not allow a slot punch due to the antenna design. HID recommends using a badge holder to attach this card to a lanyard or badge clip.

N - No Slot Punch

MIFARE DESFire EV1 High Frequency Technology Card Numbering³ (Select one option)

- M - Sequential Matching Encoded/Printed (Inkjetted)
- N - No Printed Card Numbering
- S - Sequential Encoded/Sequential Non-Matching Printed (Inkjetted)
- R - Random Encoded/Non-Matching Sequential Printed (Inkjetted)
- A - Sequential Matching Encoded/Printed (Laser Engraved)⁴
- B - Sequential Encoded/Sequential Non-Matching Printed (Laser Engraved)⁴
- C - Random Encoded/Non-Matching Sequential Printed (Laser Engraved)⁴
- U - UID (CSN) HEX card numbering only (Inkjetted)
- V - UID (CSN) Decimal card numbering only (Inkjetted)

Option - Custom Artwork¹

_____ (Specify Artwork Number - Refer to the Custom Artwork Forms for new artwork)

Enter your final card options from the above selections. Example: 282NBKGGNNN

Final Part Number		N		K				N		-	(Options #)
-------------------	--	---	--	---	--	--	--	---	--	---	-------------

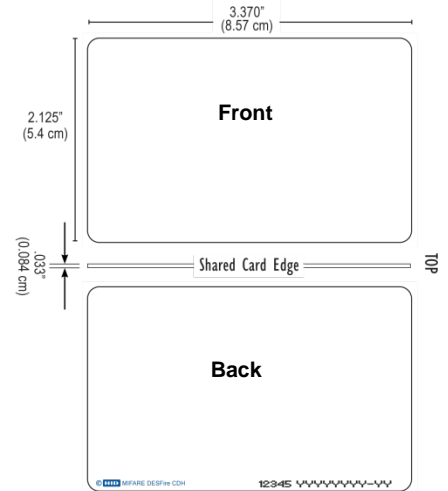



MIFARE Classic Card Programming Information

Format Number ____ (example: H10301) Bit Numbers ____ (example: 26 bit) Facility Code ____
 Encoded Card # Start ____ Stop ____ Printed Card # Start ____ Stop ____
 HID Elite ICE Number (if applicable) - ____ (Custom Format) Site Code ____ City Code ____ OEM Code ____
 Special Instructions: ____

MIFARE DESFire EV1 Card Programming Information

Format Number ____ (example: H10301) Bit Numbers ____ (example: 26 bit) Facility Code ____
 Encoded Card # Start ____ Stop ____ Printed Card # Start ____ Stop ____
 HID Elite ICE Number (if applicable) - ____ (Custom Format) Site Code ____ City Code ____ OEM Code ____
 Special Instructions: ____

- ¹ For new artwork files, contact Customer Service for custom artwork number, lead-times, and cost.
- ² Cards ordered with plain white front and back packaging, or custom artwork, will still have a small "HID logo"  and reference number printed in the lower left-hand corner and a slot punch target printed on the back of the card.
- ³ The Printed card number is placed in the bottom right-hand corner for MIFARE 13.56 MHz and in the bottom center for DESFire on the back of the card.
- ⁴ For Laser Engraved Printed numbers, consult factory for lead times and cost.
- * The composite construction is recommended for all cards with over-laminate applied. Consult with the printer manufacturer prior to ordering.

CREDENTIAL PROGRAMMERS

Understanding HID Credential programmers

HID Global offers two credential encoders enabling field programming of access credentials for use with HID Global's world class access control reader portfolio. HID Global offers credential programming for technologies from 125 kHz to 13.56 MHz, including HID Prox, iCLASS, iCLASS SE and iCLASS Seos. This How to Order Guide provides part numbers and ordering instructions for HID Global's Credential Encoders. We currently offer the following credential Encoding solution:

- **The iCLASS SE Encoder**, capable of encoding a wide range of credential technologies, including iCLASS Seos, iCLASS SE, iCLASS, HID Prox, MIFARE Classic and MIFARE DESFire EV1 from single encoder.

Credential Encoder Ordering Basics

The iCLASS SE Encoder is available for sale without a renewable lease agreement since it utilizes a credential credit process to encode cards.

To order an encoder, use the subsequent pages to

- Determine the correct Encoder part number by matching the technology and application
- Fill out the applicable Encoder lease/sales request (if applicable)
- Fill out the appropriate Credential Credit and format requests

If at any time you require assistance, contact HID Global Sales at www.hidglobal.com/customer-service



iCLASS SE Encoder Summary

The iCLASS SE Encoder Platform for encoding contactless credentials is:

- **Dynamic** - Support for a wide range of credential technologies, including iCLASS Seos, iCLASS SE, and iCLASS, HID Prox, MIFARE Classic, and MIFARE DESFire EV1 from single encoder.
- **Flexible** - Manage custom keys locally or leverage HID standard and Elite keys.
- **Convenient** - On-site programming of card stock speeds up the delivery time to obtain and issue cards.
- **Seamless** - Encode multi-tech credentials in a single pass, saving time and resources.

HID Global's iCLASS SE Encoder is an ideal solution for organizations to encode credentials and configure readers. Highly versatile, the encoder can locally manage HID Global standard Keys, Elite Keys or securely define and manage custom keys. The dynamic iCLASS SE Encoder has the capability to encode and manage a wide variety of credential technologies, interoperable with iCLASS SE readers. The solution allows users to upgrade existing card populations for use with higher security iCLASS SE Platform readers. That same flexibility also supports new credential technologies as they arise.

The iCLASS SE Encoder is available either as a desktop device as the CP1000D, or as an in-line encoder within a FARGO card printer. The in-line encoder enables organizations to graphically and electronically personalize smart cards in one seamless process, saving time and energy. This How to Order Guide will provide details for ordering credential credits, formats, and key for both the desktop and in-line encoder. To find the part number for an in-line encoder inside of a FARGO card printer, see the FARGO card printer How To Order Guide.

iCLASS SE Encoder - How Does it Work?

The iCLASS SE Encoder solution is made up of following components:

- **Hardware** - Encoder is available in either a desktop or in-line form factor
- **Software** - The encoder solution is compatible with two editions of Asure ID:
 - **Asure ID CP1000 Edition** - This edition is included with the purchase of a desktop encoder (CP1000D) and is suitable for standalone encoding. The solution enables data to be manually entered or to have it automatically increment after each encoded card.
 - **Asure ID Exchange Edition** - This edition is purchased separately and in addition to supporting the desktop encoder is the only edition which supports the in-line encoder. This solution can also connect to external databases in real-time when reading/encoding contactless cards.
- **Credential Credits** - The encoder utilizes credential credits to enable the encoding of contactless cards. The solution will decrement a credential credit each time a card has been encoded. Each credential technology and security combination will utilize a specific credential credit type (i.e. iCLASS Seos card secured with an Elite key). Credential credit part numbers are allocated for Genuine HID or Third Party Credentials. The iCLASS SE Encoder is able to determine the source of the credential during the encoding cycle and will decrement the appropriate counter accordingly.
- **Formats** - Utilizes pre-defined format templates, eliminating the need to understand access control formatting and card numbering schemes. HID formats can be ordered using this HTOG but approval may be needed for proprietary formats.
- **Keysets** - Supports HID Elite, Standard, or Custom keys. Standard and HID Elite keys can be ordered using this HTOG but approval will be needed for HID Elite keys.

The following items are included with each Desktop iCLASS SE Encoder:

1 - CP1000D Desktop Encoder

- 1 - Installation Guide
- 1 - HID USB Flash Drive
 - Asure ID CP1000 Edition Desktop Application
 - Supporting Technical Documents
 - Encoder Configuration Package (*.ise file) which includes the H10301 format, media key sets, and reader configuration key sets
- Variety of sample cards and credential credits (see table below)

Included Credential Credits		
Quantity	Part Number	Description
100,000	CRDT-K0	HID Prox Credential - Access Control
100,000	CRDT-A0	iCLASS Credential - Access Control
100,000	CRDT-A3	iCLASS SE Credential - Access Control
500,000	CRDT-A5	iCLASS (SE) Credential - Custom Data
30	CRDT-D3	iCLASS Seos Credential - Access Control
30	CRDT-D5	iCLASS Seos Credential - Custom Data
100,000	CRDT-B0	HID MIFARE Classic Credential - Access Control
100,000	CRDT-B3	HID MIFARE Classic Credential - Access Control (SIO)
500,000	CRDT-B5	HID MIFARE Classic Credential - Custom Data
100,000	CRDT-F5	Third Party MIFARE Classic Credential - Custom Data
100,000	CRDT-C3	HID MIFARE DESFire Credential - Access Control (SIO)
500,000	CRDT-C5	HID MIFARE DESFire Credential - Custom Data
100,000	CRDT-G5	Third Party MIFARE DESFire Credential - Custom Data
30	CRDT-J0	Configuration Card Generation

Included Sample Cards		
Quantity	Part Number	Description
2	1386NGGNB	HID Prox
2	2000CGGNN	iCLASS 2K
2	2003CGGNN	iCLASS 32K
2	3000VGGNN	iCLASS SE 2K
2	3003VGGNN	iCLASS SE 32K
3	5005VGGNN	iCLASS Seos 16K
2	1430NGGNN	MIFARE Classic 1K
2	1440NGGNN	MIFARE Classic 4K
2	1450CNGGNN	MIFARE DESFire EV1 8K
1	0501500295-READER	Reader Data Configuration Applet
1	0501500295-ELITE	HID Elite Prep Transport
1	2000PCCNN-LEGACY	iCLASS Legacy Transport



iCLASS SE Encoder Order Form

We recommend using the iCLASS SE Encoder HTOG Supplement to place an initial iCLASS SE Encoder order or when placing an order for additional Credential Credits, Key Sets, or Formats. However, the same information from the supplement can be derived from this HTOG.

Do you need to purchase an iCLASS SE Encoder? **(Yes / No)**

** If you are replacing a legacy programmer (i.e. CP400 or Prox Programmer) please provide a screen shot of what you are currently programming today**.

1. If you are ordering Credential Credits, Keys, or Formats for an existing iCLASS SE Encoder please identify the Encoder Serial Number (i.e. CPXXXX). The Serial Number can be found on the bottom of the desktop encoder or on the printer product label if installed within a FARGO card printer.

2. What email address should HID send the secure file with the Credential Credits, Format, or Key Sets?

3. To order additional Credential Credits please review the "iCLASS SE Encoder Credential Credit" section and enter additional Credential Credits to the order in the following table:

			Counter Ref Number (from section below)	Quantity	HID Elite ¹ ICE Number (if applicable)
Final Part Number	CRDT	-			
	CRDT	-			
	CRDT	-			

¹ HID Elite was previously known as iCLASS Elite[®]. Contact customer services for information on the authorization process.

Note: MOQ for all Credential Credits is 100. Maximum of 10,000 of each Credential Credit can be ordered at one time.

4. To order additional Key Sets please review the "iCLASS SE Encoder - Key Sets" section and enter the final iCLASS Encoder Keyset part numbers below:

			Technology Ref. Number (from section below)	Security Ref. Number (from section below)
Final Part Number	CKEYMED	-		
	CKEYCFG	-		
	CKEYSIO	-		

Note: If you are unfamiliar with smart card key sets, please contact your sales manager prior to ordering.

5. The iCLASS SE Encoder comes preconfigured with the basic HID Open 26 Bit Wiegand format (H10301), but can also be loaded with additional formats to provide extended support of credential requirements. To order additional Open non-tracked Proprietary¹ and Open Tracked²formats use the following table.

Part Number	Format Number	Facility Code ³ (If applicable)	Start Number ³ (If applicable)	End Number ³ (If applicable)	Quantity ³ (If applicable)
FRMT-J1					
FRMT-J1					



Corporate/University 1000 Format Credits

Corporate 1000[®] and University 1000[®] formats are available for use on the iCLASS SE Encoder. These formats must be ordered separately from other formats to ensure uniqueness of numbers used in both the iCLASS SE Encoder and within the HID Manufacturing Facilities. Order the Corporate or University 1000 number ranges using the indicated base part number and by completing the form below:

FRMT- J2 (Corporate/University 1000)¹

Quantity _____
 Format Number _____
 Start Number _____
 End Number _____

¹ Authorization is required. If you are not authorized to use the format, contact customer services for information on the authorization process.

² H10304 facility codes are automatically registered to the first user of that facility code. If you are not authorized to use the requested facility code, contact customer service for information on the authorization process. Alternatively state a facility code value of "new" to be automatically assigned and registered with an unused facility code.

³ Facility Code, Start Number, End Number and quantity do not apply to Open non-tracked formats but do apply to proprietary and Open-tracked formats

iCLASS SE Encoder - Credential Credits

The iCLASS SE Encoder utilizes credential credits to enable the encoding of contactless credentials. Each credential technology and security combination will utilize a specific credential credit. Also note that credential credit part numbers are allocated for Genuine HID or Third Party Credentials, the iCLASS SE Encoder is able to determine the source of the credential during the encoding cycle and will decrement the appropriate counter accordingly.

- Base Part Number **CRDT-xx** (Select xx from the tables below)

iCLASS and iCLASS Seos Technology Credential Credits

Used to encode Genuine HID Standard iCLASS 2K, 16K, or 32K and credentials or Genuine HID/Third Party Seos credentials.

Credential Type	Technology	Security				
		Standard	HID Elite ¹	SIO	HID Elite ¹ , SIO	Custom Data
Genuine HID	iCLASS	A0	A1	A3	A4	A5
Genuine HID	Seos	-	-	D3	D4	D5
Third Party	Seos	-	-	H3	H4	-
Configuration Cards		J0				

¹ Authorization is required by the end user or owner of the HID Elite (formerly iCLASS Elite) keys before these can be released. Contact customer services for information on the authorization process.

Examples:

- Genuine HID iCLASS Credential with Standard Encoding - CRDT-A0
- Genuine HID iCLASS Credential with SIO Encoding - CRDT-A3

Credential Type	Compatible with
A0	iCLASS Rev A, B, C & iCLASS SE interpreter type "T" with keyset "0"
A1	iCLASS Rev A, B, C & iCLASS SE interpreter type "T" and matching Elite ICE keyset
A3	iCLASS SE readers only interpreter type "T" or "N" with keyset "0"
A4	iCLASS SE readers only interpreter type "T" or "N" with matching Elite ICE keyset
A5	iCLASS Rev A, B, C & iCLASS SE
D3, D4, H3 & H4	iCLASS SE readers



MIFARE Classic Technology Credential Credits

Use to encode Genuine HID or third party MIFARE Classic 1K or 4K credentials.

Credential Type	Technology	Security			Custom Data
		Standard	SIO	HID Elite ¹ , SIO	
Genuine HID	MIFARE Classic	B0	B3	B4	B5
Third Party	MIFARE Classic	F0	F3	F4	F5
Configuration Cards		J0			

Example:

Third Party MIFARE Classic Credential with HID Elite and SIO Encoding - CRDT-F4

Credential Type	Reader Compatibility
B0, F0	HID 6055B, FlexSmart [®] 6071 / 6072 and Smart ID 8030DSHM & 8031DSHM (HID MIFARE Only)
B3, F3	iCLASS SE readers only (interpreter type "T" or "N") with keyset "2"
B4, F4	iCLASS SE readers only (interpreter type "T" or "N") with matching HID Elite ICE keyset
B5, F5	iCLASS SE Migration readers only with matching custom key and mapper profile

¹ Authorization is required by the end user or owner of the HID Elite (formerly iCLASS Elite) keys before these can be released. Contact customer service for information on the authorization process.

MIFARE DESFire EV1 Technology Credential Credits

Use to encode Genuine HID or third party MIFARE DESFire EV1 credentials.

Credential Type	Technology	Security		Custom Data
		SIO	HID Elite ¹ , SIO	
Genuine HID	MIFARE DESFire EV1	C3	C4	C5
Third Party	MIFARE DESFire EV1	G3	G4	G5
Configuration Cards		J0		

Example:

Third Party MIFARE DESFire EV1 Credential with SIO Encoding - CRDT-G3

Credential Type	Reader Compatibility
C3, G3	iCLASS SE readers only (interpreter type "T" or "N") with keyset "2" or matching custom key
C4, G4	iCLASS SE readers only (interpreter type "T" or "N") with matching HID Elite ICE keyset
C5, G5	iCLASS SE Migration readers only with matching custom key and mapper profile

¹ Authorization is required by the end user or owner of the HID Elite (formerly iCLASS Elite) keys before these can be released. Contact customer service for information on the authorization process.

HID Prox Technology Credential Credits

		Security
Credential Type	Technology	Standard
Genuine HID	HID Prox	K0
Configuration Cards		J0

Credential Type	Reader Compatibility
K0	All HID Prox Readers

iCLASS SE Encoder - Keysets

Key Management is a complex subject that requires some understanding of the various technologies and how smart card applications are managed. For example, encoding data on an iCLASS or MIFARE Classic card requires, at a minimum, a single authentication key to gain access to the application area or sector. The application data may have additional security enhancements requiring additional keys. The HID Application for example, requires two DES keys, one key for authentication to the app area and another key for encryption of the application data, while the Secure Identity Object requires AES keys for encryption and signing the credential. Each technology will differ in terms of the keys that need to be created and managed. The iCLASS SE Encoder includes utilities for managing individual keys as well as grouping those keys into Keys sets for ease of deployment.

To ensure your iCLASS SE Encoder is equipped with the correct keys it is necessary to order Keysets appropriately. There are three classes of keysets available which are explained below.

Media Keyset

Media keysets provide all the cryptographic keys necessary to set up and encode cards. The keys delivered with each part number will vary depending on the needs of the technology. For instance using the table below the part number CKEYMED-ICL-0 will deliver the iCLASS media Keyset with Standard or HID Elite keys for accessing the HID application area, the encryption key for the PACS data, and the key for accessing the SE application area. If you are using HID Elite Credentials, the part number will be CKEYMED-ICL-1.

Part number CKEYMED-MIF-n will deliver Key A and Key B for accessing the HID application on a MIFARE Classic card as well as transport keys for the MAD (MIFARE Application Directory).

Part number CKEYMED-DES-n delivers keys for accessing the HID application on a MIFARE DESFire EV1 card including the PICC master key, the application master key and the application read and write keys.

Reader Configuration Keyset

The Reader configuration keyset provides the privacy and authentication keys necessary to create configuration cards. Typically, configuration cards are needed to push new keys and/or configuration data to the reader. In order to utilize this solution, programmable configuration card are needed to be ordered.

Part numbers for these cards are 0501500295-READER - used for reader configuration, and 0501500295-ELITE - used for HID Elite key preparation.



SIO Keyset

The SIO Keyset provides the privacy and authentication keys for HID's Secure Identity Objects. Because SIOs are independent of card technology, their keys are ordered separately.

As a default, the iCLASS SE Encoder is loaded with the following Keysets as standard:

- iCLASS Media Keyset
 - iCLASS and Seos
 - Standard (CKEYMED-ICL-0 & CKEYMED-Seos-0)
- MIFARE Keysets
 - MIFARE Classic & MIFARE DESFire EV1
 - Standard (KEYMED-MIF-0 & CKEYMED-DES-0)
- Reader Configuration Keyset
 - Standard (CKEYCFG-0)
- SIO Keyset
 - Standard (CKEYSIO-0)

Description	Base Part Number		Technology		Security
iCLASS Media Keyset	CKEYMED	-	ICL - iCLASS MIF - MIFARE Classic DES - MIFARE DESFire EV1 SEOS - Seos	-	0 - Standard 1 - HID Elite
Description	Base Part Number		Security		
Reader Configuration Keyset	CKEYCFG	-	0 - Standard	1 - HID Elite	
SIO Keyset	CKEYSIO	-	0 - Standard	1 - HID Elite	

Supplementary Cards

To order cards or tags for use with the iCLASS SE Encoder, please see the Credentials section of this How To Order Guide. Unprogrammed cards and tags are available for most technologies, and can be ordered separately from the kit for use with your iCLASS SE Encoder.

