



15370 Barranca Parkway
Irvine, CA 92618-2215
USA

HDP5000 High Definition Card Printer/Encoder User Guide (Rev. 1.8)

Part Number: L000950

HDP5000 High Definition Card Printer/Encoder User Guide (Rev 1.8), property of HID/Fargo Electronics, Incorporated

© 2010 HID Global Corporation. All rights reserved.

Exclusive permission is granted to authorized resellers of HID Global products to reproduce and distribute this copyrighted document to authorized HID Global customers, who have signed a “no disclosure agreement” regarding the restricted, proprietary use of said document.

The revision number for this document will be updated to reflect changes, corrections, updates and enhancements to this document.

Revision Control Number	Date	Document Title
Revision 1.8	June 2010	HDP5000 High Definition Card Printer/Encoder User Guide – Corrected Print Speed
Revision 1.7	January 2010	HDP5000 High Definition Card Printer/Encoder User Guide – Power connecting method revised
Revision 1.6	December 2009	HDP5000 High Definition Card Printer/Encoder User Guide – added Vista 64 bit Support Canada Compliance Statement
Revision 1.5	MAY 2009	HDP5000 High Definition Card Printer/Encoder User Guide – added YMCKI ribbon support, Raw Magnetic Encoding, new magnetic cleaning procedure.
Revision 1.4	January 2009	HDP5000 High Definition Card Printer/Encoder User Guide

These reference documents were thoroughly reviewed to provide HID Global with professional and international standards, requirements, guidelines and models for our technical, training and user documentation. At all times, the Copyright Protection Notice for each document was adhered to within our HID Global documentation process. This reference to other documents does not imply that HID Global is an ISO-certified company at this time.

ANSI/ISO/ASQ Q9001-2000 American National Standard, (sub-title) Quality Management Systems - Requirements (published by the American Society of Quality, Quality Press, P.O. Box 3005, Milwaukee, Wisconsin 53201-3005)

The ASQ ISO 9000:2000 Handbook (editors, Charles A. Cianfrani, Joseph J. Tsiakals and John E. West; Second Edition; published by the American Society of Quality, Quality Press, 600 N. Plankinton Avenue, Milwaukee, Wisconsin 53203)

Juran's Quality Handbook (editors, Joseph M. Juran and A. Blanton Godfrey; Fifth Edition, McGraw-Hill)

Any questions regarding changes, corrections, updates or enhancements to this document should be forwarded to:

HIDGlobal Support Services
6533 Flying Cloud Drive
Eden Prairie, MN 55344 (USA)
(866) 607-7339 #6
FAX: (952) 946-8492
www.hidglobal.com

Table of Contents

HDP5000 High Definition Card Printer/Encoder User Guide (Rev. 1.8)	1
Section 1: Printer Overview	10
HDP5000 Process Flow (in table format)	10
Reviewing the HDP5000 Boot-up Sequence	10
Reviewing the HDP5000 Sequence of Operations	11
Reviewing the Lamination Module Boot-up Sequence	14
Reviewing the Lamination Module Sequence of Operations	14
Section 2: Specifications	15
Safety Messages (review carefully)	15
Regulatory Compliances	16
Agency Listings	17
United States	17
Canada	17
Environmental Protection (China-RoHS)	17
Traditional Chinese RF Emissions and Safety Statements	18
Simplified Chinese	19
Technical Specifications	20
Functional Specifications	29
Printer Components: Resin Thermal Transfer to USB Interface Port	30
Printer Components: LCD and Softkey Control Pad	31
Printer Components: Print Ribbons	33
Printer Components: Blank Cards	34
Printer Components: Card Input and Output Hoppers	35
Printer Components: Card Output Hopper and Reject Hopper	35
Printer Components: Transfer Roller	36
Reviewing the Overlaminates	37
Reviewing the Thermal Transfer Film and PolyGuard Overlaminates	37
Reviewing the CR-80 Patch Size	38
Reviewing the Overlamine Design	38
Section 3: Setup and Installation Procedures	39
Inspection – HDP5000	39
Unpacking the Printer.	39
Unpacking the Printer	40
Choosing a Good Location	41
About Moisture Condensation	41
Printer Media Loading Procedures	42
Loading the Print Ribbon	42
Loading the Clear HDP Transfer Film	45
Inserting the Card Cleaning Roller	48
Loading the Overlamine	50
Loading the Blank Cards	53
Connecting Power to HDP5000 Printer and Lamination Module	55
Printer Driver Installation Procedures	57
Printer Driver Update Procedure	65
Installing Printer Driver Updates	65
Section 4: Printer Driver Operations	67
Safety Messages (review carefully)	67
HDP500 Printer Driver Options	68
Reviewing Printer Drivers	68
Using the Card tab	68

Selecting the Card Size _____	69
Selecting the Card Type _____	70
Setting the Orientation _____	73
Specifying the number of Copies _____	74
Selecting the Diagnostics button _____	75
Printing a Test Print Image _____	76
Selecting the About button _____	78
Selecting the Toolbox button _____	79
Using the Device Options tab _____	80
Detecting Supplies at Print Time Function _____	81
Adjusting the Ribbon Type _____	84
Adjusting the Film Type _____	86
Using the Dual Sided Group Functions _____	87
Using the Dual Sided - Print Both Sides option _____	88
Using the Print Both Sides - Split 1 Set of Ribbon Panels option _____	89
Using the Print Both Sides - Print Back Image on Front of Card option _____	90
Using the Dual Sided - Print Back Side Only option _____	91
Using the Options Group _____	92
Using the Rotate Front 180 Degrees or Rotate Back 180 Degrees options _____	93
Using the Disable Printing option _____	94
Using the Dual Pass and Invert F-Panel Image options _____	95
Using the Image Color tab _____	96
Using the Image Quality – Color Matching dropdown _____	97
Adjusting for the Resin Dither _____	101
Using the Advanced Image Color window _____	102
Using the Image Transfer tab _____	107
Adjusting the Image Position controls _____	108
Adjusting the Transfer Dwell Time and Temperature _____	110
Using the Default button _____	112
Using the Magnetic Encoding tab _____	113
Using the Encoding Mode dropdown list _____	114
Selecting the Coercivity/Magnetic Track _____	120
Reviewing the Shift Data Left Function _____	121
Using the Character Size buttons _____	122
Using the ASCII Offset dropdown list _____	123
Using the Bit Density dropdown list _____	124
Using the LRC Generation dropdown list _____	125
Using the Character Parity Mode dropdown list _____	126
Reviewing the ISO Track Locations _____	127
Sending the Track Information _____	128
Reviewing the Sample String _____	129
Reviewing the ASCII Code and Character Table _____	130
Using the Default button _____	131
Using the Lamination tab (HDP5000-LC) _____	132
Selecting the Lamination Position _____	133
Adjusting the Lamination Speed - Transfer Dwell Time _____	134
Selecting the Lamination Side dropdown menu _____	135
Selecting the Lamination Type _____	136
Selecting the Defaults button _____	138
Using the K Panel Resin tab _____	139
Using the Click and Drag capability _____	140
Selecting “inches or mm” radio button _____	140
Using the Add and Delete buttons _____	140
Selecting the Full Card _____	141
Selecting the Defined Area(s) _____	142
Selecting the Undefined Area(s) _____	143

Defining the Area to activate the Card Grid	144
Selecting the Print YMC under the K and Print K Only options	145
Using the Printer Supplies tab	147
Reviewing Information on the Supplies tab	148
Section 5: Accessory Procedures	149
Using the Security Lock Slot on the HDP5000	149
Installation and Removal Procedures Flipper Module Accessory	151
Installing the Flipper Module Accessory	152
Section 6: General Troubleshooting	154
Troubleshooting - LCD and Printer Error Message Tables.	154
How to use the LCD Error Message Table (example provided)	155
Troubleshooting with the LCD Error Message Table	156
Troubleshooting with the Printer Error Message Table	173
Communications Errors	187
Resolving the Communication Errors	187
Printing a Test Image using the Workbench Diagnostic	189
Reviewing the Alignment Self Test Card	190
Reviewing the Magnetic Self Test	191
Reviewing the YMCK Self Test	191
Reviewing the Color Bars Self Test	192
Reviewing the Device Settings Self Test	193
Reviewing the Resin Self Test	194
Section 7: Ethernet Option Section	195
Introduction	195
Technical Specification - Ethernet Option	195
Functional Specification - Ethernet Option	196
Network Services - Overview	197
Reviewing the Print Server	197
Reviewing the Web Page Server	197
Reviewing the Network Management Interface	197
Reviewing the Telnet Server	197
Network Management Interface	198
Telnet Command Line Interface	198
Initiating a Telnet Session	198
Reviewing the Telnet Command Table	199
Ethernet Web Pages – Standard Procedures	205
Reviewing Web page security	205
Logging In	205
Accessing the Home page	207
Reviewing the Home Page	208
Reviewing the Home Page Categories and Fields (table)	209
Configuring the Network Settings	209
Accessing the Network Settings page	210
Reviewing the Interface	211
Reviewing the Current Settings	211
Switching to the Automatic IP Address Mode	212
Changing to the Static IP Address Mode	213
Using the Clear Changes button	215
Using the Media Information page	216
Using the TCP/IP page	217
Using the Printer page	219
Using the System Log page	221
Changing the Log Name	222
Selecting the Log Type	223

Selecting the Log Destination _____	224
Setting up Email Event logging _____	225
Specifying UDP Event logging _____	226
Specifying TCP Event logging _____	228
Using the Administration pages _____	230
Using the System Information page _____	230
Changing the Root Password _____	232
Using the Reboot pages _____	233
Rebooting the Printer _____	233
Upgrading the Main Firmware _____	234
Using the Print Path page _____	238
Using the Help page _____	240
Additional Ethernet Procedures _____	240
Accessing the Ethernet Status LEDs _____	240
Reviewing the HDP5000 LED Table _____	240
Upgrading the Main Firmware with the Fargo Workbench Printer Utility _____	241
Restoring the Factory Settings for Ethernet _____	243
Resetting the HDP5000 settings _____	243
Changing the HDP5000 LCD Network Settings _____	243
Accessing the Network Setup Menu _____	243
Changing the DHCP Setting _____	244
Changing the ANEG setting _____	245
Saving addresses _____	246
Resetting Passwords _____	246
Accessing the HDP5000 IP Address _____	247
Ethernet Printer Troubleshooting Procedures _____	248
Troubleshooting procedures _____	248
Verifying the Printer Connection _____	249
Verifying the Printer IP address _____	249
Verifying that your PC can access the Printer using the ping command _____	250
Printing a test page _____	251
Reviewing Frequently-asked Questions-Ethernet _____	252
Glossary of Terms _____	258
Section 8: Card Lamination Module _____	261
Printer Unit: Reviewing the Card Lamination Module _____	261
Reviewing the Card Lamination Module _____	262
Installing the Card Lamination Module _____	263
Introduction _____	263
Inspecting the Card Lamination Module _____	263
Unpacking the Card Lamination Module _____	263
Choosing a proper Location _____	263
Preventing Moisture Condensation _____	264
Installing the Lamination Module Accessory _____	264
Adjusting the Lamination Placement on the Card _____	266
Adjusting the Card Flattener _____	268
Section 9: Printer Adjustments _____	269
Printing on Alternate Card Stocks _____	269
Selecting the Right Cards and optimizing the HDP Print Process _____	269
Conducting the Tape Adhesion Test _____	270
Conducting the Tape Adhesion Test _____	271
Section 10: Toolbox _____	272
Accessing the Toolbox _____	272
Selecting the Configuration tab _____	273
Using the Configuration Tab _____	274

Using the Optional Printer Features Group Box	274
Using the Event Monitoring Group Box	275
Reviewing the Ribbon Low message	275
Reviewing the Laminate Low Message	275
Using the Film Low message	276
Selecting the Set Language for Printer LCD Display Group Box	276
Selecting the Calibrate Laminator tab	277
Selecting the Calibrate Film tab	278
Selecting the Calibrate Ribbon tab	279
Selecting the Clean Printer tab	280
Using the Clean Printer Group Box	282
Selecting the Advanced Settings tab	282
Using the Image Darkness Option	284
Using the Print Top of Form Option	285
Using the Print Left of Form Option	287
Using the Mag Top of Form Option	288
Using the Print Flip Angle Option	289
Using the Print Flip Level Option	289
Using the Encoder Flip Angle Option	290
Setting the Printhead Resistance	290
Using the Transfer TOF Adjustment Option	290
Using the Transfer Temp Offset Option	292
Using the Ribbon Print Takeup Tension Option	292
Using the Film Print Takeup Tension Option	292
Using the Ribbon Print Supply Tension Option	293
Using the Film Supply Transfer Tension Option	294
Using the Film Takeup Transfer Tension Option	294
Using the Resin Heat Adjust Option	295
Using the Sleep Time Option	295
Using the Standby Time Option	295
Using the Blush Point Option	295
Using the LCD Contrast Option	295
Using the Cleaning rate Option	295
Using the EAT Disable Option	296
Using the Film Print Cooling Level Option	296
Using the Film Transfer Cooling Level Option	296
Using the Enable Ribbon Wrinkle Compensation Option	296
Using the Holo Transfer Offset Option	296
Using the Standby Temp Option	296
Using the Mag Hi-Co Voltage Offset Option	297
Using the Mag Lo-Co Voltage Offset Option	297
Using the Mag Flipper Angle Offset Option	297
Using the Lamination Top of Form Option	297
Using the Lamination End of Form Option	297
Using the Lamination Bottom Takeup Option	297
Using the Lamination Top Takeup Option	297
Using the Lamination Card Backup Option	298
Using the lamination Card Length Option	298
Reviewing the No Printer Connected error message	298
Reviewing the Value outside the Range error message	298
Section 11: Cleaning	299
Using the Required Supplies	299
Accessing the Clean Printer tab	300
Cleaning the Printer Platen Roller and Card Feed Rollers	300
Cleaning inside the Printer	303

Cleaning outside the Printer _____	303
Cleaning the Printhead _____	304
Replacing the Card Cleaning Roller _____	305
Cleaning the Magnetic Encoder _____	306
Cleaning the Magnetic Encoder when installed in the Flipper _____	307
Replacing or Cleaning the FAN foam filter _____	308
Section 12: Fargo Workbench Printer Utility _____	309
Reviewing the Card tab and Diagnostic button _____	309
Section 13: Fluorescent Panel Usage _____	310
Configuring Fluorescent Data (F-Panel for YMC FK Ribbon) using the Workbench _____	312
Configuring Fluorescent Data (F-Panel for YMC FK Ribbon) using the Application _____	322
Section 14: Inhibit Panel Usage _____	325
Using Inhibit Panel (via the Fargo Workbench Printer Utility) _____	325
Using Inhibit Panel with an Application _____	328
Generating Text Objects _____	328
Rendering Print Jobs _____	329
Rendering Print Jobs _____	330
Using the Test Print _____	337
Using the Test Print _____	338
Troubleshooting the Inhibit Panel _____	339
Section 15: Packing the Card Printer _____	340
Section 16: Firmware Updates _____	341
Performing the Firmware Updates _____	341
Section 17: HID Global Technical Support _____	347
Contacting Technical Support _____	347
Reading the Serial Numbers on the Printer _____	348
Finding out when a Fargo Card Printer was manufactured _____	348
Section 18: Glossary of Terms _____	349

Section 1: Printer Overview

HDP5000 Process Flow (in table format)

Reviewing the HDP5000 Boot-up Sequence

Step	Process
1	The Card feed stepper turns ON (to check for a card in the card path).
2	The Lam Headlift turns until the head up position is returned from the Headlift Sensor).
3	The Film transfer take-up Motor turns ON to take up any slack in the film.
4	The Print Headlift turns until head up position is returned from Headlift Sensor.
5	The Print Ribbon moves forward until it finds the yellow panel, pauses, advances to magenta, then backs up to yellow (the Ribbon Sensor detects the color of the ribbon).
6	The Transfer Film advances forward two panels from supply (advances until the Print Film Sensor senses 2 marks on the Film).
7	The Transfer Film advances forward one panel from supply (advances until the Print Film Sensor senses 1 mark on the Film).
8	The Transfer Film reverses for one panel onto supply (reverses until the Print Film Sensor senses 1 mark on the Film).
9	The Transfer Film reverses for one panel onto supply (reverses until the Print Film Sensor senses 1 mark on the Film).

Reviewing the HDP5000 Sequence of Operations

The following sequence describes a dual-sided, full color print job with magnetic encoding.

Step	Process
1	The File information is received from the PC.
2	The Heater warms up and/or maintains the heat on the hot Roller using the RTD (Resistive Thermal Device) to help maintain the desired temp.
3	The DC Motor and Stepper Motor turn ON and run until a card is seen by the card Sensor, which will cause the Card Input Motor to stop. The Stepper will continue to run a certain number of steps to position the card under the Card Feed/Position Sensor.
4	For a magnetic print job, the Stepper will continue moving the card until the trailing edge is positioned under the Mag Head. All stop.
5	Stepper will turn ON in reverse direction and encode card. All stop.
6	Stepper will again turn on and position the trailing edge of the card under the Mag Head. All stop.
7	Stepper will turn ON in reverse direction and verify data encoded onto mag stripe.
8	Stepper continues transporting card until the trailing edge is positioned under the Card Feed/Position Sensor. All stop.
9	The Ribbon Drives turn ON and move until the correct panel is found by the Print Ribbon Sensor. All stop. (Note: The Print Ribbon Encoder is active during this step.) This step occurs simultaneously with Step 10 (below).
10	The Film Drives turn ON until the Film is positioned with the Film Print Alignment Sensor. (Note: This is the closest Sensor to the Print Platen Roller.) All stop. (Note: The Film Ribbon Encoder is active during this step.)

Reviewing the HDP5000 Sequence of Operations

Step	Process
11	The Headlift Motor engages, moving the Printhead down until Headlift Sensor is activated. All stop.
12	The Fan turns ON as required to keep head cool.
13	The Ribbon Drives, Film Drive and Print Platen Stepper turn ON and the Printhead burns the image data until the image data is depleted. All stop. (Note: The Ribbon Encoders and Film Encoders are active during this step.)
14	The Headlift Motor engages, moving the Printhead up until the Headlift Sensor is activated. All stop. The Film Drive reverses the Film Position Sensor to print over the image (again).
15	Repeat Steps 9 to 14 for the appropriate number of color/heat seal panels.
16	The Film Drives turn ON to rewind the printed portion of the Film into position at the heated Transfer Roller using the Lamination Film Alignment Sensor.
17	If the heater is not at the required temperature yet, the job will pause.
18	Stepper engages to move the card to a position directly over the Transfer Roller. The Card Feed/Position Sensor determines card edge and number of steps to position card. All stop.
19	The Headlift Motor turns ON to raise the Transfer Roller and will stop when the Headlift Sensor is activated. All stop.
20	The Stepper and Film Drive engage to laminate the printed Film onto the card. They will turn off after a given number of steps based on the position given by the card Sensor. All stop. (Note: The Film Encoder is active during this step.)
21	The Headlift Motor turns ON to lower the Transfer Roller, stopping when the Headlift Sensor is activated.

Reviewing the HDP5000 Sequence of Operations

Step	Process
22	The Film Drive and Stepper turn ON for a given number of clicks based on Film Encoder, until the film is released.
23	The Stepper turns ON to move the card into Flipper Module to flip the card to the opposite side. After flipping the card is transported back to the Card Feed/Position Sensor to repeat Steps 9 to 14. Upon completion of print all print cycles the card is transported to the Output Hopper (based on steps from a known from Flipper Card Position Sensor). All stop.
24	The Heater is maintained at a set temperature by the RTD when the Printer is ON. The cooling fan is ON when the Printhead is ON or hot.

Reviewing the Lamination Module Boot-up Sequence

Step	Process
1	The Lam Headlift turns until the head up position is returned from Headlift Sensor.
2	The Lamination Ribbon Motor activates. (Note: The RFID determine the presence of a roll of lamination.)
3	The Card Sensor checks for the presence of a card and ejects it if found.

Reviewing the Lamination Module Sequence of Operations



The LAM sequence of operations begins after printing has occurred with the Card Printer.

Step	Process
1	The card is fed onto the Lamination Module.
2	The card is fed to the Card Position Sensor.
3	The Lamination Take-up Motor begins cycling until the Lamination Sensor detects the mark.
4	The Card Feed Motor activates to place the leading edge of the card on the Lam Roller.
5	The Lam Roller Lift Motor cycles until the Transfer Roller Lift Sensor detects the roller is down.
6	The Card Feed Motor and the Lamination Drive Motor activate for the length of the card.
7	The Lam Roller Lift Motor cycles until the Lam Roller Lift Sensor detects the roller is up.

Section 2: Specifications

The purpose of this section is to provide the User with specific information on the Regulatory Compliances, Agency Listings, Technical Specifications and Functional Specifications for the HDP5000 and HDP5000-LC Printers.

Safety Messages (review carefully)

Symbol	Critical Instructions for Safety purposes
<p>Danger:</p> 	<p>Failure to follow these installation guidelines can result in death or serious injury.</p> <p>Information that raises potential safety issues is indicated by a warning symbol (as shown to the left).</p> <ul style="list-style-type: none"> • To prevent personal injury, refer to the following safety messages before performing an operation preceded by this symbol. • To prevent personal injury, always remove the power cord prior to performing repair procedures, unless otherwise specified.
<p>Caution:</p> 	<p>This device is electrostatically sensitive. It may be damaged if exposed to static electricity discharges.</p> <p>Information that raises potential electrostatic safety issues is indicated by a warning symbol (as shown to the left).</p> <ul style="list-style-type: none"> • To prevent equipment or media damage, refer to the following safety messages before performing an operation preceded by this symbol. • To prevent equipment or media damage, observe all established Electrostatic Discharge (ESD) procedures while handling cables in or near the Circuit Board and Printhead Assemblies. • To prevent equipment or media damage, always wear an appropriate personal grounding device (e.g., a high quality wrist strap grounded to avoid potential damage). • To prevent equipment or media damage, always remove the Ribbon and Cards from the Printer before making any repairs, unless otherwise specified. • To prevent equipment or media damage, take jewelry off of fingers and hands, as well as thoroughly clean hands to remove oil and debris before working on the Printer.

Regulatory Compliances

Term	Description
CSA (cUL)	The Printer manufacturer has been authorized by UL to represent the Card Printer as CSA Certified under CSA Standard C22.2 No. 60950-1-03. File Number: E145118
FCC	The Card Printer complies with the requirements in Part 15 of the FCC rules for a Class A digital device.
UL	The Card Printer is listed under UL IEC 60950-1 (2001) INFORMATION TECHNOLOGY EQUIPMENT. (Note: This product is intended to be supplied by a Listed Power Unit marked "Class 2" and rated for 24 V dc, 3.75 to 5 A.) File Number: E145118

Agency Listings

Term	Description
Emissions Standards	CE, FCC, CRC c1374, EN 55022 Class A, FCC Class A, EN 55024: 1998, EN 61000-3-2 and EN 61000-3-3.
Safety Standards	UL IEC 60950-1 (2001), CSA C22.2 No. 60950-1-03.

United States

This device complies with Part 15 of the FCC rules. Operation is subject to the following two conditions:

- (1) This device may not cause harmful interference.
- (2) This device must accept any interference received, including interference that may cause undesired operation.

Note: This equipment has been tested and found to comply with the limits for a Class A digital device, pursuant to part 15 of the FCC Rules. These limits are designed to provide reasonable protection against harmful interference when the equipment is operated in a commercial environment. This equipment generates, uses, and can radiate radio frequency energy and, if not installed and used in accordance with the instruction manual, may cause harmful interference to radio communications. Operation of this equipment in a residential area is likely to cause harmful interference in which case the User will be required to correct the interference at his own expense.

Canada

This Class A digital apparatus complies with Canadian ICES-003.

C'et appareil numerique de la classe A est conforme a la norme NMB-003 du Canada.

Caution: Changes or modifications not expressly approved by the party responsible for compliance could void the user's authority to operate the equipment.

Environmental Protection (China-RoHS)

Environmental Protection Use Period is based on the product being used in an office environment.

Traditional Chinese RF Emissions and Safety Statements

传统中文 射频放射及安全指令

安全信息 (小心检查)

标记	重要的安全事项说明安全
危险: 	<p>未按照说明安装可能造成人员伤亡。</p> <p>在可能产生潜在安全问题的地方有警示标记。(如左图所示)。</p> <p>为了防范人员伤害, 做带此警示标记的操作前, 参考安全信息提示。</p> <p>为了防范人员伤害, 在没有特别说明的情况下, 修理前关掉电源开关。</p>
小心: 	<p>此设备对静电很敏感。如果受到静电放电, 设备会被损害。</p> <p>在可能产生潜在静电安全问题的地方有警示标记。(如左图所示)。</p> <p>为了防范损害设备, 做带此警示标记的操作前, 参考安全信息提示。</p> <p>为了防范损害设备, 在排放电路板和打印头联合装置里面或附近的电线时, 请注意观察所有的静电放电设备。</p> <p>为了防范损害设备, 贴身佩戴合适的接地装置 (比如: 手腕上带一个高质量的接地皮带以免受到可能的伤害)。</p> <p>为了防范损害设备, 如果没有特殊说明, 在做任何修理前, 请取下打印机上的色带和卡。</p> <p>为了防范损害设备, 在使用打印机之前, 请摘下戒指和手上饰品, 仔细清洗手上的油脂。</p>

經型式認證合格之低功率射頻電機, 非經許可, 公司、商號或使用者均不得擅自變更頻率、加大功率或變更原設計之特性及功能。低功率射頻電機之使用不得影響飛航安全及干擾合法通信; 經發現有干擾現象時, 應立即停用, 並改善至無干擾時方得繼續使用。前項合法通信, 指依電信法規定作業之無線電通信。低功率射頻電機須忍受合法通信或工業、科學及醫療用電波輻射性電機設備之干擾。

Simplified Chinese

如何使用本手册

实际上, HDP5000 证卡打印机用户指南 是一本整个证卡打印机的故障排除和服务手册。本手册旨在帮助安装人员和技术人员快速有效地查找相关过程、组件和术语。安装人员或技术人员可根据自己的喜好, 高效地使用本手册的电子文档或纸面文档。

安全消息(请仔细阅读)

符号	安全事项的重要说明
危险: 	<p>如果不遵循这些安装指南进行操作, 可能会导致重伤, 甚至死亡。</p> <p>可能引发安全问题的信息由警告符号(如左图所示)来表示。</p> <p>为了确保人身安全, 在执行前面带有此符号的操作之前, 请先阅读下面的安全消息。</p> <p>为了确保人身安全, 除非另有规定, 否则在执行维修过程前, 始终应断开电源。</p> <p>为了确保人身安全, 只能由有资格的人员执行这些过程。</p>



安全消息(请仔细阅读)

符号	安全事项的重要说明
小心: 	<p>此设备为静电敏感设备。如果暴露在静电电压下, 可能会损坏设备。</p> <p>可能引发静电安全问题的信息由警告符号(如左图所示)来表示。</p> <p>为了防止设备或介质受损, 在执行前面带有此符号的操作之前, 请先阅读下面的安全消息。</p> <p>为了防止设备或介质受损, 请在处理电路板 and 打印头部件中或附近的电缆时, 遵守所有规定的静电放电(ESD)过程。</p> <p>为了防止设备或介质受损, 请始终佩戴适当的个人接地设备(例如, 已接地避免出现潜在损坏的高质量腕带)。</p> <p>为了防止设备或介质受损, 除非另有规定, 否则在执行任何维修过程前, 始终应将色带和证卡与打印机分离。</p> <p>为了防止设备或介质受损, 在操作打印机前, 请取下手指和手上的珠宝首饰物, 并将手上的油渍和污渍彻底清洗干净。</p>

Technical Specifications

Term	Description
Accepted Card Thickness	<ul style="list-style-type: none"> • Print only: .030" (30 mil) to .050" (50 mil) / .762mm to 1.27mm • Print/Lamination: .030" (30 mil) to .040" (40 mil) / .762mm to 1.02mm
Accepted Electronic Card types	HID Proximity Cards, Mifare Contactless Smart Cards and Contact Smart Cards, iClass
Accepted Card Types (Compositions)	ABS, PVC, PET, PETG, Proximity Cards, Contact Smart Cards, Magnetic Stripe cards and Optical Memory Cards
Card Cleaning	Replaceable cleaning roller (included with each print Ribbon)
Colors	Up to 16.7 million colors and 256 shades per Pixel.
Input Card Cartridge Capacity	<p>HDP5000 and HDP5000-LC: 100 cards (.030in./ .762mm)</p> <p>Has refillable Card Cartridge that can either be attached to the Printer or detached for storage. This allows single feed with the Card Cartridge removed or with no other cards in the Card Cartridge</p>
Output Hopper Card Capacity	<p>HDP5000 and HDP5000-LC: 200 card Output Hopper capacity (.030" / .762mm)</p> <p>Includes Reject Hopper capability when connected to the Flipper Module with available storage on the Output Tray or the Lamination Module</p>

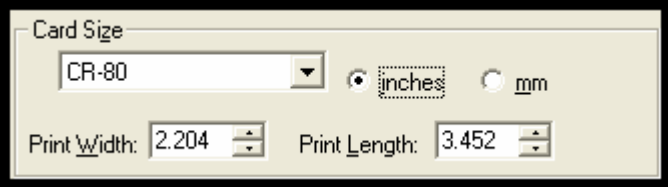
Technical Specifications

Term	Description
<p>Card Sizes (Accepted Standard sizes)</p>	<p>HDP5000 and HDP5000- CR-80: This selection is the default form size for the HDP5000. This will print a 3.370 in. L x 2.125 in. W (85.6mm L x 54mm W) image including a .04 over-bleed on each of the 4 sides.</p> <ul style="list-style-type: none"> • CR-80 (default values): Card Size supported is 2.204 X 3.452 (56 X 87.7 mm). <p>Standard Card Size in inches (HDP5000 Printer Driver > Card tab)</p>  <p>Standard Card Size in mm (HDP5000 Printer Driver > Card tab)</p> 

Technical Specifications

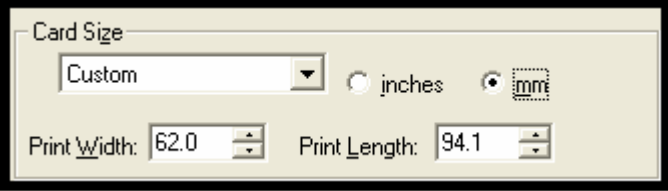
Term	Description
<p>Card Size (Custom selection)</p>	<p>Sets Custom Card Size when closing dialog box.</p> <ul style="list-style-type: none"> • Print Width default = 2.440, upper limit = 2.440, lower limit = 1.000, cannot be null • Print Length default = 3.704, upper limit = 3.704, lower limit = 3.000, cannot be null <p>Changing back to CR-80 resets to CR-80 defaults.</p> <p>Custom Card Size in inches (HDP5000 Printer Driver > Card tab)</p>  <p>Custom Card Size in mm (HDP5000 Printer Driver > Card tab)</p> 

Technical Specifications

Term	Description
<p>Card Size (inches and mm)</p>	<p>Choice of inches or mm changes the counter choice on the K Panel Resin tab. See below.</p> <ul style="list-style-type: none"> • Inches displays card size in inches. • mm displays card size in mm. <p>Changing Print Width or Print Length dimensions automatically changes drop down to Custom.</p> 
<p>Colors (dpi)</p>	<p>300 dpi (11.8 dots/mm)</p>
<p>Dimensions</p>	<ul style="list-style-type: none"> • HDP5000: 11.50"H x 12.25"W x 9.25"D / 292mmH x 313mmW x 235mmD • HDP5000 + Dual-Sided Module: 11.50"H x 17.50"W x 9.25"D / 292mmH x 445mmW x 235mmD • HDP5000 + Single-Sided Lam Module: 12.75"H x 25"W x 9.25"D / 324mmH x 635mmW x 235mmD • HDP5000 + Dual-Sided Module + Dual-Sided Lam Module: 12.75"H x 30"W x 9.25"D / 324mmH x 762mmW x 235mmD • Lam Module: 12.75"H x 12.25"W x 9.25"D / 324mmH x 313mmW x 235mmD
<p>Display</p>	<p>User-friendly, SmartScreen™ LCD Control Panel</p>

Technical Specifications

Term	Description
Encoding Options (only HDP5000 and HDP5000-LC)	<ul style="list-style-type: none"> • ISO Magnetic Stripe Encoding Module, dual high- and low-coercivity, Tracks 1, 2 and 3 • JIS II Magnetic Stripe Encoding Module • Raw Magnetic Encoding • E-card Docking Station (required for all e-card options or 3rd party smart card encoding) • Contact Smart Card Encoder (ISO 7816), Parts 1-4; T=0 and T=1 • Contactless Smart Card Encoder (Mifare®) • Prox Card Encoder (HID read-only) (Note: Corporate Express 1000 Cards can be used with special order Weigand/ASCII Converter) • iCLASS™
Fargo Certified Supplies	<p>Fargo Card Printer/Encoder requires highly specialized media to function properly.</p> <p>To maximize printed card quality and durability, Printhead life and Printer/Encoder reliability, use only Fargo Certified Supplies, Fargo warranties are void, where not prohibited by law, when non-Fargo Certified Supplies are used.</p>
HDP Film Options	<ul style="list-style-type: none"> • Clear, 1,500 prints • Standard Holographic (500 prints) (only HDP5000 and HDP5000-LC) • Custom Holographic, special order (500 prints) (only HDP5000 and HDP5000-LC)
HDP Film Storage Temperature	77°F (25°C) or lower for no longer than 1.5 years.

Technical Specifications

Term	Description
Humidity	20% to 80% (non-condensing)
Input Hopper Card Capacity	HDP5000 and HDP5000-LC: <ul style="list-style-type: none"> • 100 cards (.030/.762mm)
Interface	<ul style="list-style-type: none"> • USB 2.0 (high speed) and Ethernet with internal print server • Interfacing information for E-card Options
Maximum Accepted Card Width	2.125W / 54mmW
Maximum Accepted Card Length	3.375L / 85.6mmL
Memory	16MB RAM
Operating Temperature	65° F to 90° F (18° C to 32° C).
Options	<ul style="list-style-type: none"> • Card Lamination Module – single-sided or double sided • Magnetic stripe encoding dual-sided (simultaneous) • 200-card input hopper • Smart card encoding (contact/contactless) • Dual-sided printing • Door and cartridge locks • Printer cleaning kit
Output Hopper Card Capacity	HDP5000/HDP5000-LC <ul style="list-style-type: none"> • 200 cards (.030mm)

Technical Specifications

Term	Description
Overlamine Options (HDP5000-LC and HDP5000 only)	<p>All overlaminates are available in either clear, holographic globe design or custom holographic design. They can also be optimized for use with smart cards and Magnetic Stripes.</p> <p>Here are the options:</p> <ul style="list-style-type: none"> • Thermal Transfer Overlamine, .25 mil thick, 500 prints • PolyGuard® Overlamine, 1.0 mil and .6 mil thick, 250 prints (PolyGuard available in a CR-80 patch size)
Power Supply	<ul style="list-style-type: none"> • 80W for HDP5000 • 160W (two 80W bricks) for the HDP5000-LC <p>(Note: This product is intended to be supplied by a Listed Power Unit marked "Class 2" and rated for 24 V dc, 3.75 to 5 A.)</p>
Print Area	Over-the-edge on CR-80 cards.
Printing Method	HDP™ Dye-Sublimation / Resin Thermal Transfer
Print Ribbon Options	<p>HDP5000 and HDP5000-LC (prints or images):</p> <ul style="list-style-type: none"> • Full color, YMC*, 750 prints • Full color with resin black, YMCK*, 500 prints • Full color with two resin black Panels, YMCKK*, 500 prints • Full color YMC with resin black and heat seal panel for difficult-to-print surfaces, YMCKH*, 500 prints • Full color YMC with resin black and UV fluorescing panel, YMCFK*, 500 prints • Full color YMC with resin black and Inhibitor panel, YMCKI*, 500 prints • Premium Black Resin (K) 3000 prints <p>*Indicates the Ribbon type and the number of Ribbon panels printed where Y=Yellow, M=Magenta, C=Cyan, K=Resin Black, H=Heat Seal and F=Fluorescing</p>

Technical Specifications

Term	Description
Print Speed-Batch Mode	<p>HDP5000 and HDP5000-LC (see note below):</p> <ul style="list-style-type: none"> • 26 seconds per card / 138 cards per hour (YMC with transfer)* • 32 seconds per card / 113 cards per hour (YMCK with transfer)* • 47 seconds per card / 77 cards per hour (YMCKK with transfer)* • 47 seconds per card / 77 cards per hour (YMCKH with transfer)* • 47 seconds per card / 77 cards per hour (YMCFK with transfer)* • 37 seconds per card / 97 cards per hour (YMCK with transfer and dual-sided, simultaneous lamination)* • 52 seconds per card / 69 cards per hour (YMCKI with transfer)* • 17.5 seconds per card/ cards per hour (K with transfer) • *Print speed indicates an approximate print speed and is measured from the time a card feeds into the Printer to the time it ejects from the Printer. • *Print speeds do not include encoding time or the time needed for the PC to process the image. • *Process time is dependent on the size of the file, the CPU, amount of RAM and the amount of available resources at the time of the print.
Resolution	300 dpi (11.8 dots/mm)
Single Wire USB 2.0 Encoding Options	<ul style="list-style-type: none"> • ISO Magnetic Stripe Encoding, dual high- and low-Coercivity, Tracks 1, 2 and 3 • Contactless Smart Card Encoder (HID iClass and MIFARE) • Contact Smart Card Encoder reads from and writes to all ISO7816-1/2/3/4 memory and microprocessor smart cards (T=0, T=1) as well as synchronous cards • Prox Card Reader (HID read-only)
Supply Frequency	50 Hz / 60 Hz

Technical Specifications

Term	Description
Software Drivers	Windows 2000, Windows XP, Windows 2003, Vista (32 bit & 64 bit), (MAC OSX & Linux Driver and User Guide on www.hidglobal.com Optional Drivers available on www.hidglobal.com
Supply Voltage	100-240 VAC, 3.8A (HDP5000 and HDP5000-LC)
Supported Printers/Models	HDP5000 & HDP5000 with Card Lamination Module: <ul style="list-style-type: none"> • Ethernet • USB
System Requirements	<ul style="list-style-type: none"> • x86 based PC or compatible • Windows 2000, Windows XP, Windows 2003, Vista (32 bit & 64 bit) • 500MHz computer with 256MB of RAM or higher • 500MB free hard disk space or higher
Warranty	<p>Printer: Two year (including On-Call Express, U.S. only); optional Extended Warranty Program (U.S. only); see below for more detail.</p> <ul style="list-style-type: none"> • Two (2) Year Factory Warranty • Covers parts and depot repair • First year On-Call-Express (loaner printer U.S. only) • 2nd year On-Call-Express available for a fee. This must be purchased before the first year On-Call-Express expires. • Extended Warranties available <p>Printhead: Lifetime; unlimited pass with Fargo-certified Cards</p>
Weight	<ul style="list-style-type: none"> • HDP5000: 16 lbs. / 7.3 kg • HDP5000 + Dual-Sided Module: 22 lbs. / 10 kg • HDP5000 + Single-Sided Lam Module: 28 lbs. / 12.7 kg • HDP5000 + Dual-Sided Module + Dual-Sided Lam Module: 36 lbs. / 16.4 kg

Functional Specifications

The Card Printer utilizes two different, yet closely related printing technologies to achieve its remarkable print quality for dye-sublimation and resin thermal transfer.

The following describes how each of these technologies works:

Function	Description
Dye-Sublimation	<p>Dye-Sublimation is the print method the Card Printer uses to produce smooth, continuous-tone images that look photographic. (Note: This process uses a dye-based Ribbon roll that is partitioned by a number of consecutive color Panels.)</p> <p>Process colors: The Panels are grouped in a repeating Series of three process colors - yellow, magenta and cyan (YMC), along the entire length of the Print Ribbon.</p> <p>Panels: The Printer always prints the yellow Panel first, followed by the magenta Panel and the cyan Panel.</p> <p>Printhead: As the Print Ribbon passes beneath the Printhead, hundreds of thermal elements within the Printhead heat the dyes on the Ribbon. (Note: When these dyes are heated, they vaporize and diffuse into the surface of the film and then the film is laminated onto the card surface. A separate pass is made for each of the three color Panels on the Ribbon.)</p> <p>Color Shades: By combining the colors of each Panel and by varying the heat used to transfer these colors, it is possible to print up to 16.7 million different shades of color. (Note: This blends one color smoothly into the next, producing photo-quality images with absolutely no dot pattern.)</p> <p>Dye-Diffusion Thermal Transfer: It is the process of heating a dye suspended in a cellulosic substrate until the dye can flow, diffusing into the dye receptive surface of the card or InTM. This produces the image in the surface of the card.</p> <p>Inhibit Panel: The Inhibit or I designation under YMCKI indicates the ability to prevent the transfer of film to the card surface. Users can select these Ribbon types to prevent film from transferring over security features, signature panel or other areas of special interest on the card surface</p> <p>Fluorescing Panel: The fluorescing panel (F) will allow you to print a standard or one-to-one personalized grayscale fluorescing image that is completely invisible until exposed to ultraviolet light.</p>

Printer Components: Resin Thermal Transfer to USB Interface Port

Component	Description
Resin Thermal Transfer	<p>Resin Thermal Transfer is the print method the Printer uses to print sharp black text and crisp bar codes that can be read by both infrared and visible-light bar code scanners.</p> <p>Like dye-sublimation, this process uses the same thermal Printhead to transfer color to a film from a resin-only Print Ribbon or the resin black (K) Panel of a full color Print Ribbon.</p> <p>The difference, however, is that solid dots of resin-based ink are transferred and fused to the surface of the film and then the film is laminated onto the card surface. (Note: This produces very durable, saturated printing.)</p>
Card Cartridge	Load blank cards into this Cartridge.
Card Output Hopper	Stores 200 cards.
Card Lamination Module	<p>Works in conjunction with the Printer to apply a variety of different overlaminates to printed cards, providing increased card durability and security.</p> <p>(Note: When printing a batch of cards, the Printer can be encoding and printing one card while the Lamination Module laminates another card.)</p>
LCD Display	Displays the current status of the Printer.
Printhead	The component of the Printer that actually does the printing. This component is fragile and must not be bumped or touched with anything other than a cleaning pen.
Softkey Buttons	Current function is displayed above the button and will change depending upon the Printer's mode of operation.
Card Cleaning Roller	Automatically cleans cards for higher print quality. (Note: Replace this Roller after every 1000+ cards or as needed.)
Power Port	Connect to the included power supply.
USB Interface Port	Connect to the Windows PC USB cable, LAN Connector.

Printer Components: LCD and Softkey Control Pad

The Printer provides a two line, thirty-two (32) characters LCD Display that can communicate helpful information about the Printer's operation. The bottom line of the LCD Display will always be used to communicate the current function of the Printer's softkey buttons.

This section describes how the LCD Display and Softkey Control Pad work together.

Component	Description
Softkey Buttons	<p>The Printer has two softkey buttons that appear below the LCD Display. Their current function is indicated by the words appearing above them. This function will change according to the Printer's current mode of operation.</p> <ul style="list-style-type: none"> • Press the corresponding softkey button under the choice you want to select. If no word appears above a particular button, this indicates it has no function in that particular mode of operation.
LCD Display	<p>The Printer's LCD Display will change according to the Printer's current mode of operation.</p>
Ready / Printer Open Screens	<p>Once the Printer has finished its system check and with the Printer closed, the Printer will display Printer Ready to indicate that the Printer is ready for operation. (Note: The Printer will stay in this mode until it receives a print job or it is turned OFF.)</p> <ul style="list-style-type: none"> • If the Printer is opened, the Cover is Open screen will appear. Press either the Forward or Back buttons to move the Printer's card path Rollers in the indicated direction. (Note: This is helpful when cleaning the Printer or if clearing jammed media.) • All rollers will move even if the Lam cover is not opened.

Printer Components: LCD and Softkey Control Pad







Component	Description
Print Status Screen	<p>During operation, the LCD will indicate the current Print Status by showing you the area of the Printer that is active. It does this by displaying the following messages:</p> <ul style="list-style-type: none"> • FEEDING: Indicates that cards are being fed into the Printer. • FLIPPING: Indicates that the card is being transported to the Flipper Module. • ENCODING: Indicates the encode station is encoding a card (appears only if you are using a Printer with an optional built-in Encoding Module). • PRINTING: Indicates the Printer is printing onto the HDP film. • RECEIVING DATA: Indicates that the Printer is receiving data from the PC. • TRANSFERRING: Indicates the Printer is transferring an image to a blank card. • LAM: Indicates the Lamination Station is applying an overlamine to a card (appears only if using a Printer equipped with the optional Card Lamination Module). <p>The Print Status screen always displays Cancel in the lower left and Pause in the lower right.</p>
The Cancel button	<p>Use this button to cancel print jobs and reset the Printer for the next print job. Cancel now has two options:</p> <ul style="list-style-type: none"> • Cancel single job in memory. • Cancel all jobs in memory. <p>This Cancel All function will cancel all print jobs in the Printer and will completely reset the Printer. In this case, be sure to cancel the print jobs from the PC before pressing YES.</p>
The Pause button	<p>Use this button to pause the Printer at any time during operation. Note the Printer will always finish its current task before pausing.</p> <p>When the Printer is paused, the Pause softkey button will change to Resume.</p> <p>Press Resume continuing Printer operation.</p>

Printer Components: Print Ribbons

The Card Printer utilizes both dye-sublimation and/or resin thermal transfer methods to print images (print to film and transfer film to card). Since the dye-sublimation and the resin thermal transfer print methods each provide their own unique benefits, Print Ribbons are available in dye-sublimation-only and combination dye-sublimation/resin versions.

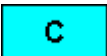
To make it easier to remember which Print Ribbons are which, a letter code has been developed to indicate the type of Ribbon Panels found on each Ribbon.

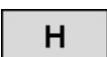
This letter code is as follows:

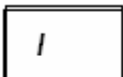
	= Dye-Sublimation Yellow Panel
	= Dye-Sublimation Magenta Panel
	= Dye-Sublimation Cyan Panel
	= Resin Black Panel
	= Heat Seal Panel
	= Dye-Sublimation Fluorescent Panel
	= <i>Inhibit Panel</i>

Printer Components: Blank Cards



Caution: Never run cards with a contaminated, dull or uneven surface through the Printer. Printing onto such cards will ultimately lead to poor print quality. Always store the card stock in its original packaging or in a clean, dust-free container. Do not print onto cards that have been dropped or soiled.

Type	Description
Card Size	These Card Printers accept standard CR80 sized cards (3.375L x 2.125W / 85.6mmL x 54mmW) with a thickness of 30 mil to 50 mil (.030/.762mm).
Card Design	<p>The Printer will print onto any card with a clean, level and polished PVC surface. (Important: Composite PVC is recommended over straight PVC for the best results and for ISO card specification compliance. Single-side straight PVC does not conform to ISO compliance at this time.)</p> <p>The Printer will print onto any card with a clean, level and polished PVC surface.</p>
Card Surface	<p>Suitable cards must have a polished PVC surface free of fingerprints, dust or any other types of embedded contaminants.</p> <p>In addition, cards must have a completely smooth, level surface in order for the Printer to achieve consistent color Coverage.</p> <p>Some types of Proximity cards, for example, have an uneven surface which will inhibit consistent color transfer.</p> <p>Likewise, some smart card chips are raised slightly above the cards surface, which also results in poor color transfer.</p>
UltraCard stock	<p>Due to the importance of using high-quality blank cards, a factory-approved card stock called UltraCard™ is available and recommended for best results.</p> <p>UltraCard stock has a glossy PVC laminate on top and bottom and is optically inspected to provide the cleanest, most scratch and debris-reduced cards possible.</p> <p>Two types of these cards are available: UltraCard and UltraCard Premium III.</p> <p>UltraCard stock has a PVC core and offers medium card durability.</p> <p>Recommended: UltraCard Premium III stock has a 40% polyester core and offers high durability.</p> <p>Both types of UltraCards produce printed images with a glossy, photo-quality finish.</p>

Printer Components: Card Input and Output Hoppers

Type	Description
Card Cartridge	The Card Cartridge will hold a maximum of 100 cards (based on a standard 30 mil card thickness).

Printer Components: Card Output Hopper and Reject Hopper

Type	Description
Card Output Hopper	<p>HDP5000/HDP5000-LC:</p> <p>All standard HDP Card Printers provide a 200 card capacity Card Output Hopper (based on a standard 30 mil card thickness). (Note: This Hopper stores the cards after they are printed.) Shown in the lower left.</p> <p>Reject hopper functionality when connected to the Flipper Module. The storage is available on the output tray or the Lamination Module.</p>
Reject Hopper	Shown in the upper left of the image below.



Printer Components: Transfer Roller



Danger: The Printer's Transfer Roller can reach temperatures exceeding 350 degree F (175 C). Use extreme caution when operating the Transfer Roller. Never touch the Transfer Roller unless the Printer Power has been turned off for at least 20 to 30 minutes.

Type	Description
Controls	Both the Printer itself and the Printer's software Driver control the built-in Transfer Roller.
Temperature Adjustment	<p>To change the temperature of the Transfer Roller, adjust its temperature through the Image Transfer Tab within the Printer Driver setup window.</p> <p>Once adjusted, the new temperature settings will be sent down with the next print job along with the rest of the Printer Driver information.</p>
New Temperature Setting	<p>Before printing begins, the Transfer Roller will automatically adjust itself to the new temperature setting. (Note: This new temperature setting will remain programmed within the Printer until it is once again changed within the Printer Driver or until the Printer is turned OFF.)</p> <p>Whenever the Printer is turned OFF, the Transfer Roller will automatically reset itself and return to its default temperature the next time the Printer is turned ON.</p> <p>Disconnect the Printer's power supply. (Technician Note: Cycling the Printer's power supply serves to reset the Transfer Roller to its default temperature. The temperature setting within the Printer Driver, however, will stay the same until it is changed.)</p>

Reviewing the Overlaminates

Important! Fargo Card Printers require highly specialized overlaminates to function properly. To maximize Printer life, reliability, printed card quality and durability, you must use only Fargo Certified Supplies. For this reason, the Fargo warranty is void, where not prohibited by law, if you use non-Fargo Certified Supplies. To order additional materials, please contact the authorized reseller.

Reviewing the Thermal Transfer Film and PolyGuard Overlaminates

Term	Description	Cross Reference
Thermal Transfer Film and PolyGuard Overlaminates	<p>The Card Lamination Module will accept either a Thermal Transfer Film overlaminate or a Polyester Patch Overlaminate called PolyGuard™.</p> <ul style="list-style-type: none"> • Thermal Transfer Film: The Thermal Transfer Film overlaminate is a relatively thin material which Covers a card Edge-to-Edge and provides a medium level of card durability and security.) • PolyGuard Overlaminate: PolyGuard is a much thicker material which does not Cover Edge-to-Edge, but provides an extremely high level of card durability and security. (Note: PolyGuard is available in either a 1.0 or .6 mil thickness and should always be used for those applications requiring the highest degree of card durability and security.) 	See the Loading the Overlaminate .

Reviewing the CR-80 Patch Size

Term	Description	Cross Reference
CR-80	PolyGuard Overlamine is available in a standard CR-80 patch size. (Note: Thermal Transfer Film overlamine will accommodate the CR-80 size.)	See the Loading the Overlamine .

Reviewing the Overlamine Design

Term	Description	Cross Reference
Design	Both PolyGuard and the Thermal Transfer Film overlamines are available in either a clear or generic secure holographic-type design. (Note: Custom holographic-type overlamines are also available with specific designs, patterns, logos and security features.) Please contact the authorized reseller for more information about custom Overlaminates.	See the Loading the Overlamine .

Section 3: Setup and Installation Procedures

Inspection – HDP5000

While unpacking your Printer, inspect the carton to ensure that no damage has occurred during shipping. Make sure that all supplied accessories are included with your unit.

Unpacking the Printer.

The following items are included with your Printer:

- Software Installation CD (includes Printer Driver, Online User's Guide and Printer Diagnostic Tool)
- Power Supply with Power Cord (**Note:** This product is intended to be supplied by a Listed Power Unit marked "Class 2" and rated for 24 V dc, 3.75 to 5 A.)
- Card Cleaning Roller
- Card Cartridge
- Card Output Bin
- Warranty Card

This is included with the HDP5000-LC Only:

- Card Lamination Module - Power Supply with Power Cord

(Important: Please use the original packaging when shipping the HDP5000 Printer/Flipper/Laminator. This will require the Laminator Module to be detached from the Printer or Flipper prior to shipping.)

Unpacking the Printer.

Display A – See the HDP5000 Printer Installation Guide

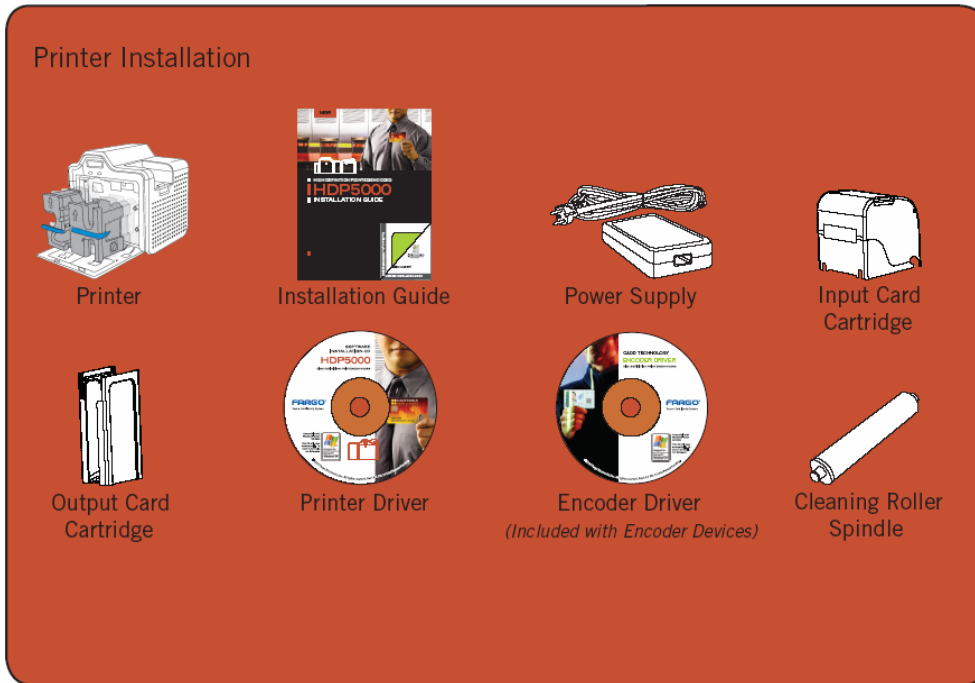

Unpacking the Printer

Display B – See the HDP5000 Printer Installation Guide

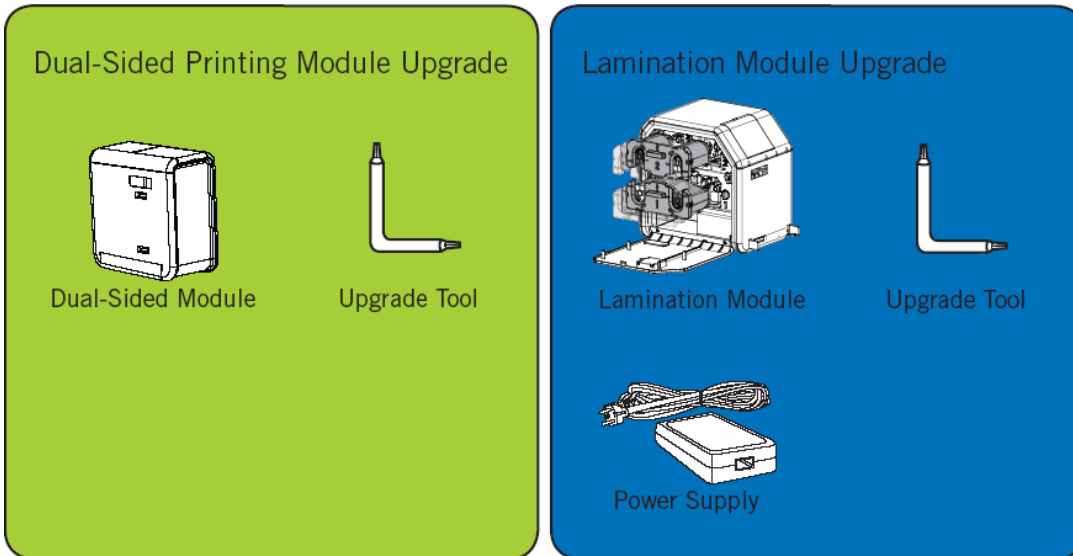

Choosing a Good Location

Follow these guidelines:

- Place the unit in a location with adequate air circulation to prevent internal heat build-up.
- Use the Printer's dimensions as a guideline for the minimum clearances to the unit.
(**Note:** Allow for adequate clearance above the unit to accommodate the height of the unit with its Covers open.)
- Do not install unit near heat sources such as radiators or air ducts or in a place subject to direct sunlight, excessive dust, mechanical vibration or shock.

About Moisture Condensation

If the unit is brought directly from a cold to a warm location or is placed in a very damp room, moisture may condense inside the unit. Should this occur, print quality may not be optimum.

Leave the unit turned OFF in a warm, dry room for several hours before using. This will allow the moisture to evaporate.



Caution: For safety purposes, Ethernet is not intended for a direct connection outside of the building.

Printer Media Loading Procedures

Loading the Print Ribbon

Note: Fargo Card Printers require highly specialized supplies to function properly.

- To maximize Printer life, reliability, printed card quality and durability, you must use only Fargo Certified Supplies.
- For this reason, your Fargo warranty is void, where not prohibited by law, if you use non-Fargo Certified Supplies.

Step	Procedure
1	Load the Print Ribbon into the Print Ribbon Cartridge until the Rolls click.

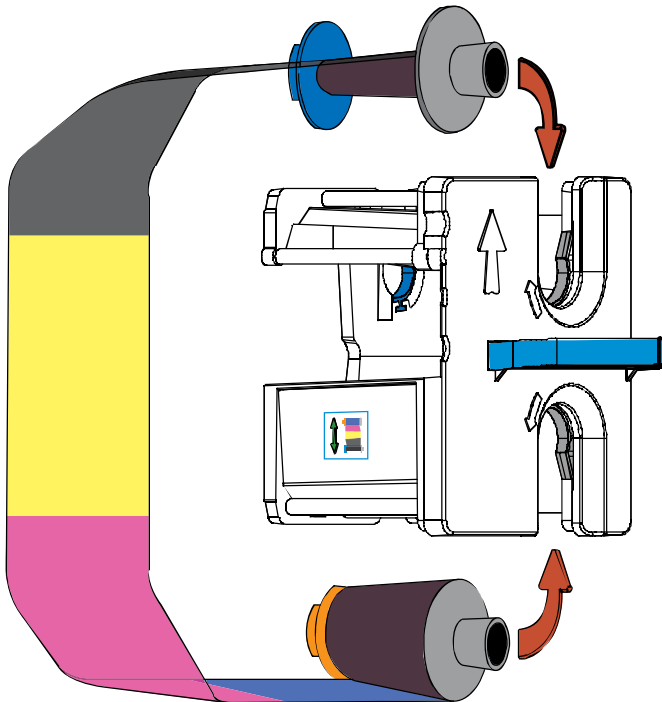

Loading the Print Ribbon

Step	Procedure
2	Tighten the Print Ribbon.

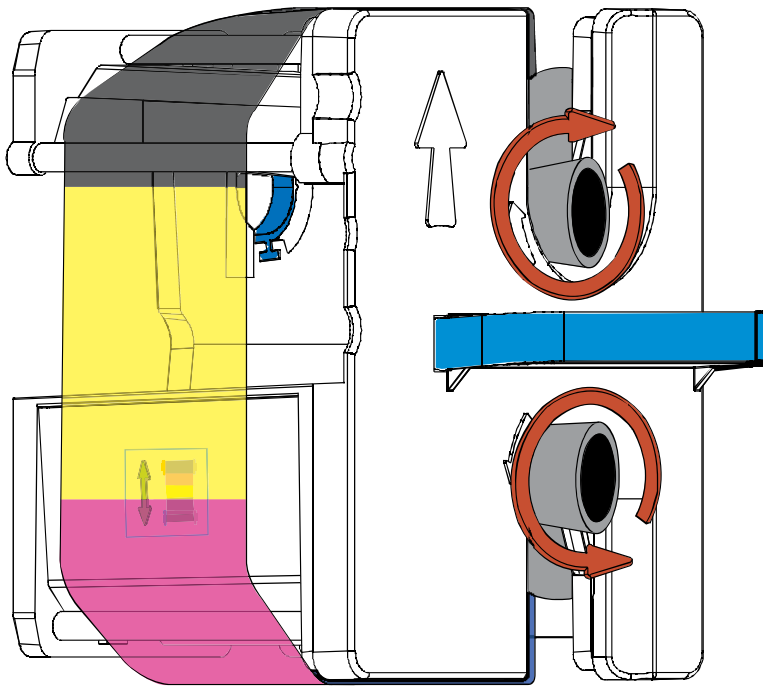

Loading the Print Ribbon

Step	Procedure
3	Insert the Print Ribbon Cartridge into the Printer until it clicks.

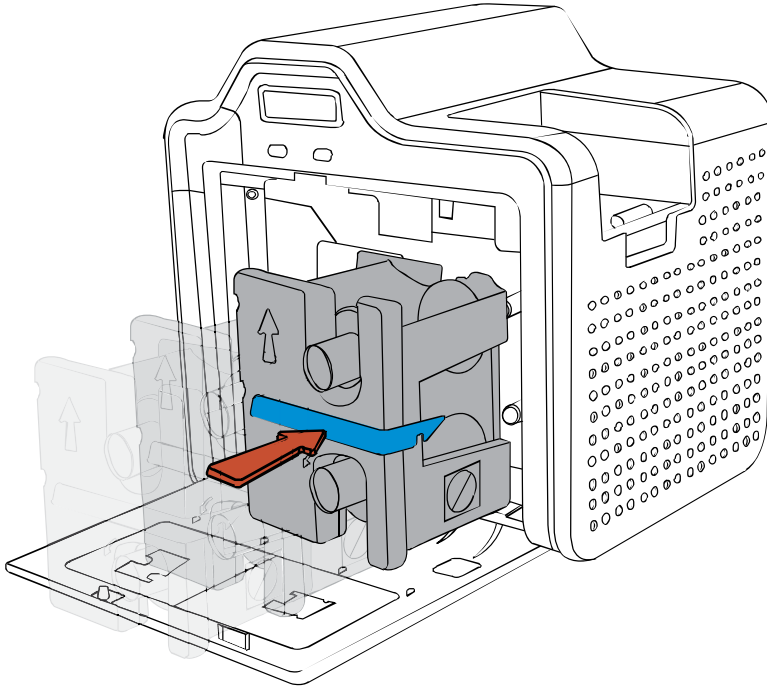

Loading the Clear HDP Transfer Film

Step	Procedure
1	Load the HDP Film into the HDP Film Cartridge until the rolls click.

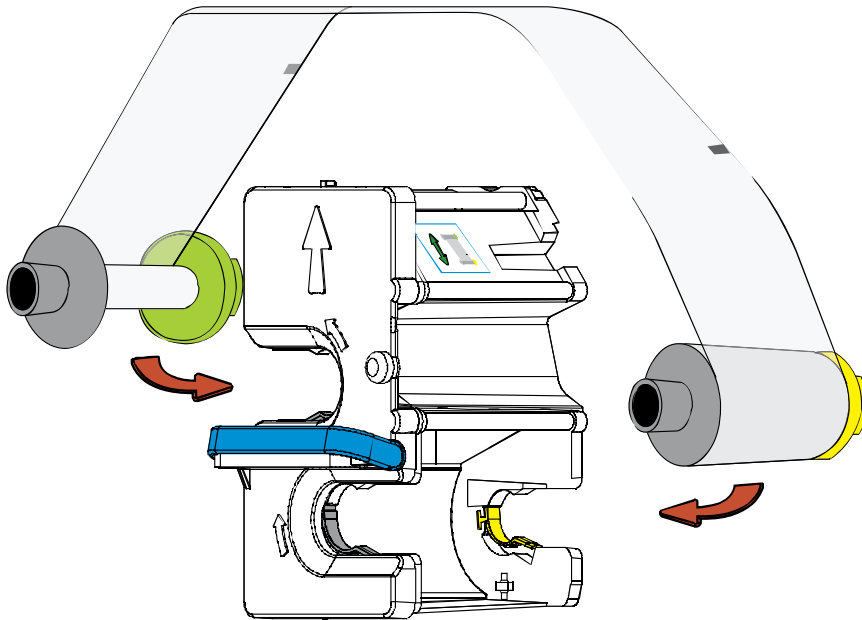

Loading the Clear HDP Transfer Film

Step	Procedure
2	Tighten the HDP Film.

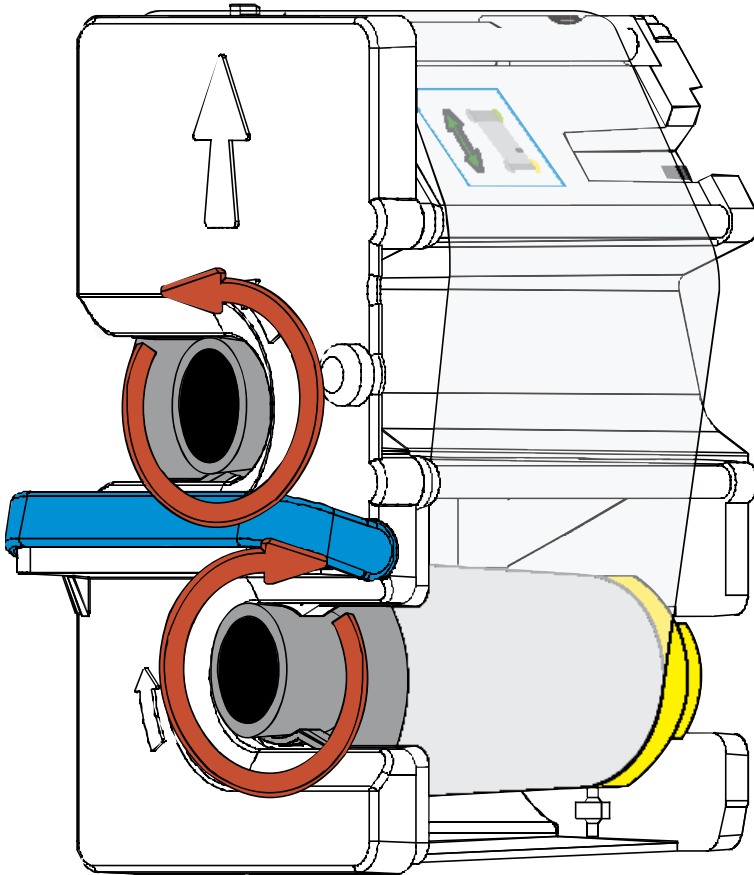

Loading the Clear HDP Transfer Film

Step	Procedure
3	Insert the HDP Film Cartridge into the Printer until it clicks.

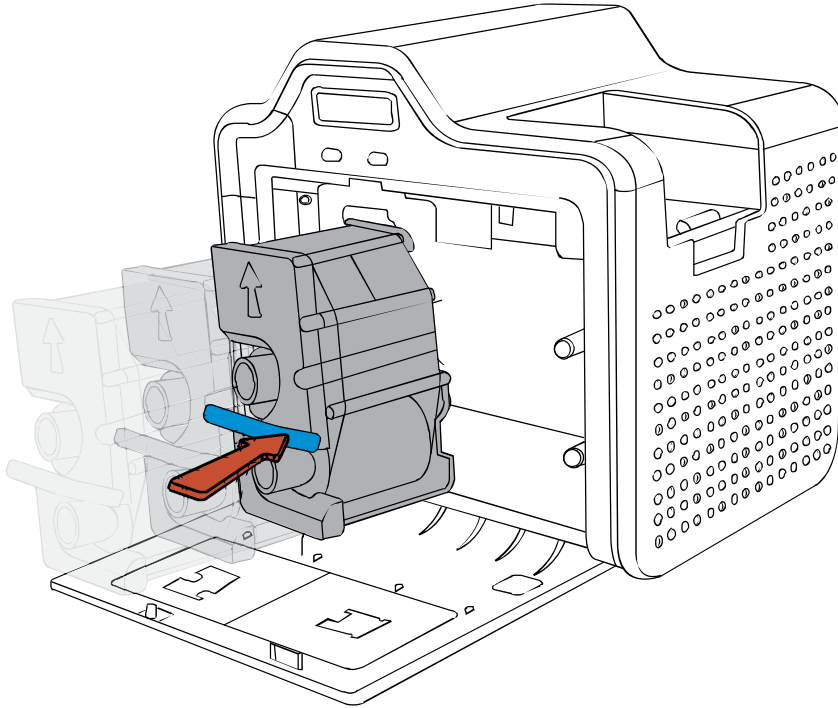

Inserting the Card Cleaning Roller

Step	Procedure
1	Remove the Card Cleaning Roller from the Print Ribbon packaging and insert the Cleaning Roller onto the black spindle from the supply pack.

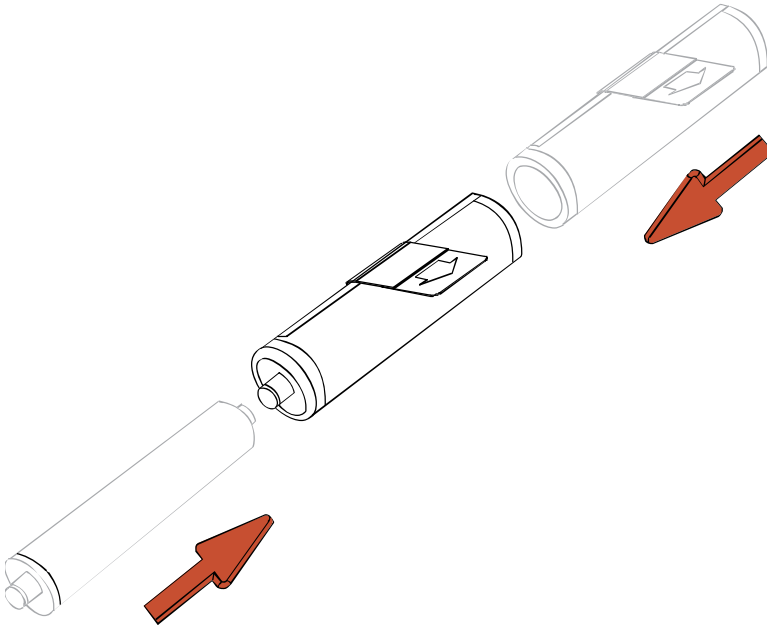

Inserting the Card Cleaning Roller

Step	Procedure
2	Remove the protective sleeve from the Card Cleaning Roller.

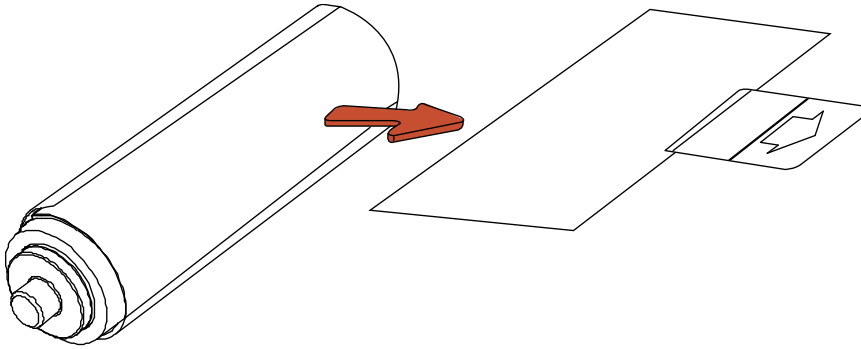

Step	Procedure
3	Insert the Card Cleaning Roller into the card input area.

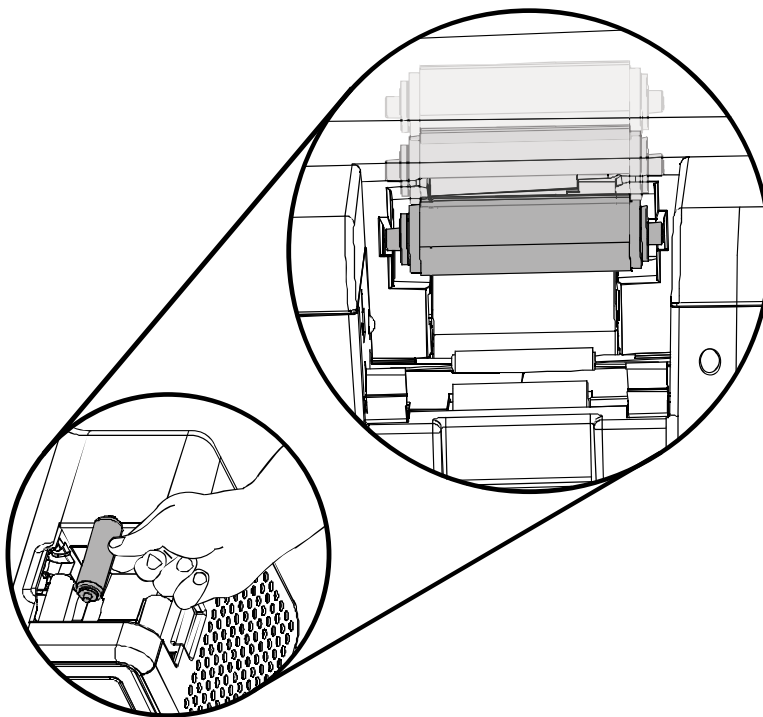

Loading the Overlaminates

(**Note:** This procedure only applies to the HDP5000-LC.)

The loading process for both the Thermal Transfer Overlaminates and the PolyGuard™ Overlaminates material is the same. Refer to the following steps to load either type of overlaminates into the Printer.

Step	Procedure
1	Remove the overlaminates from its packaging.
2	Load the Lamination Rolls into the Cartridges until they click.

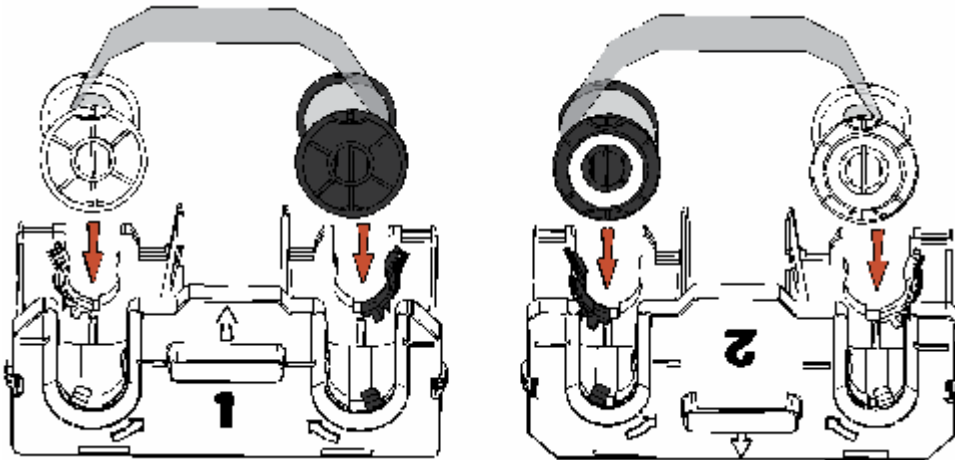

3	Tighten the Lamination Rolls.
---	-------------------------------

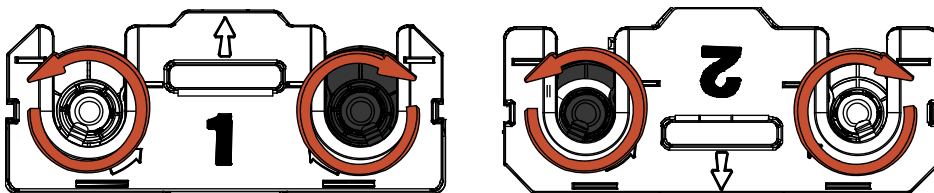

Loading the Overlaminates

Step	Procedure
4	Insert the Overlaminates Cartridges into the Lamination Module until they click.

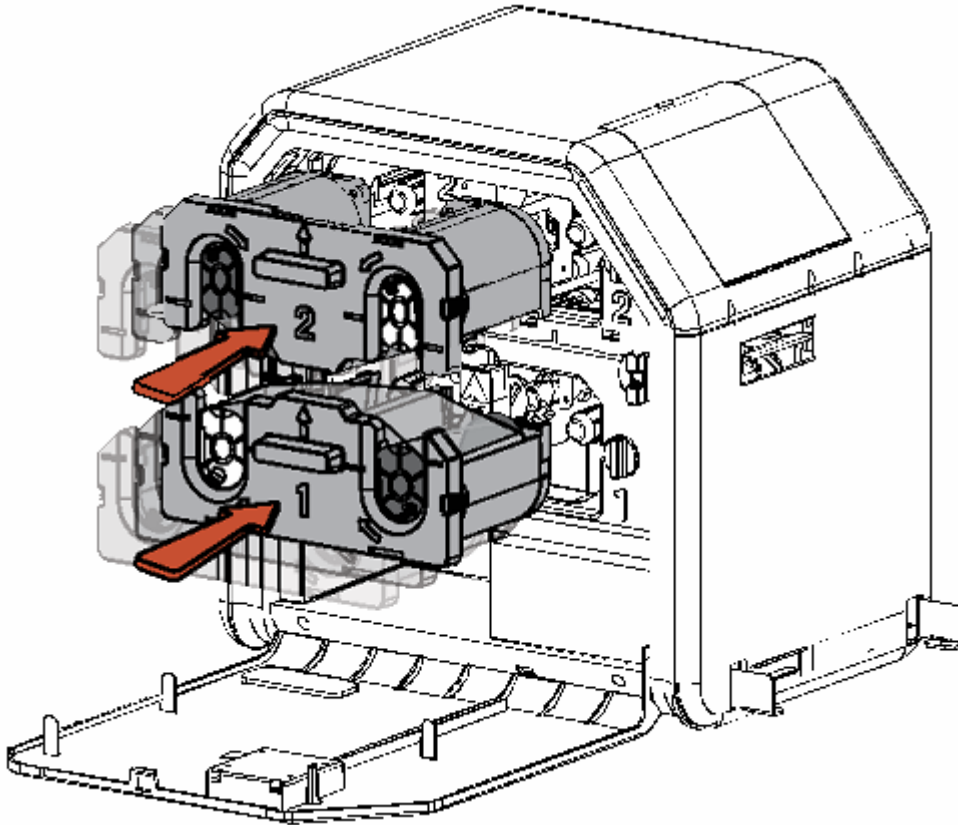

Loading the Overlaminates

Step	Procedure
5	Close the Lamination Module Front Cover.

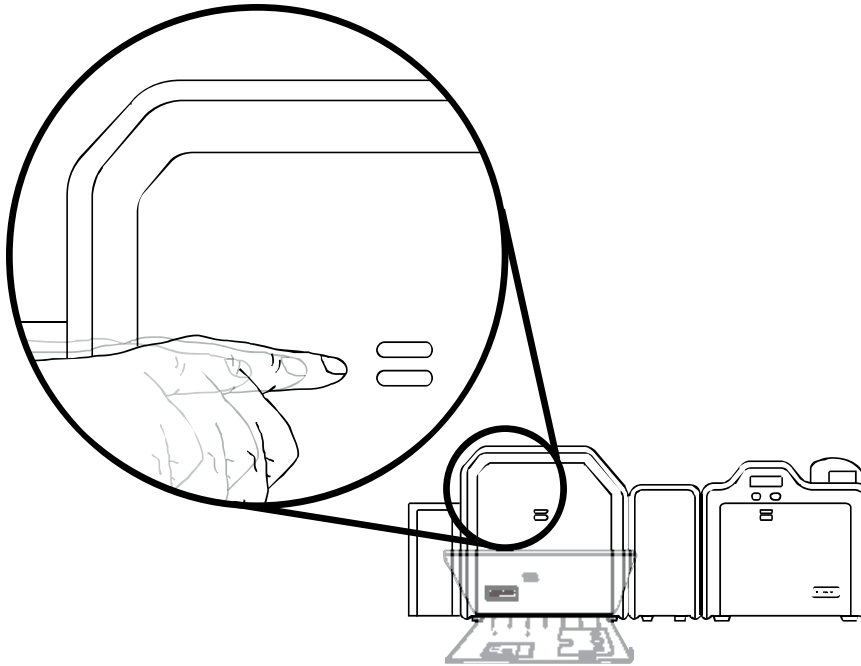

Loading the Blank Cards

Step	Procedure
1	Load the blank cards into the Card Cartridge, as shown below. Important: The front of the card must face DOWN. The back of the card or the magnetic stripe on the card must face UP. The Smart Chip is loaded on the bottom.

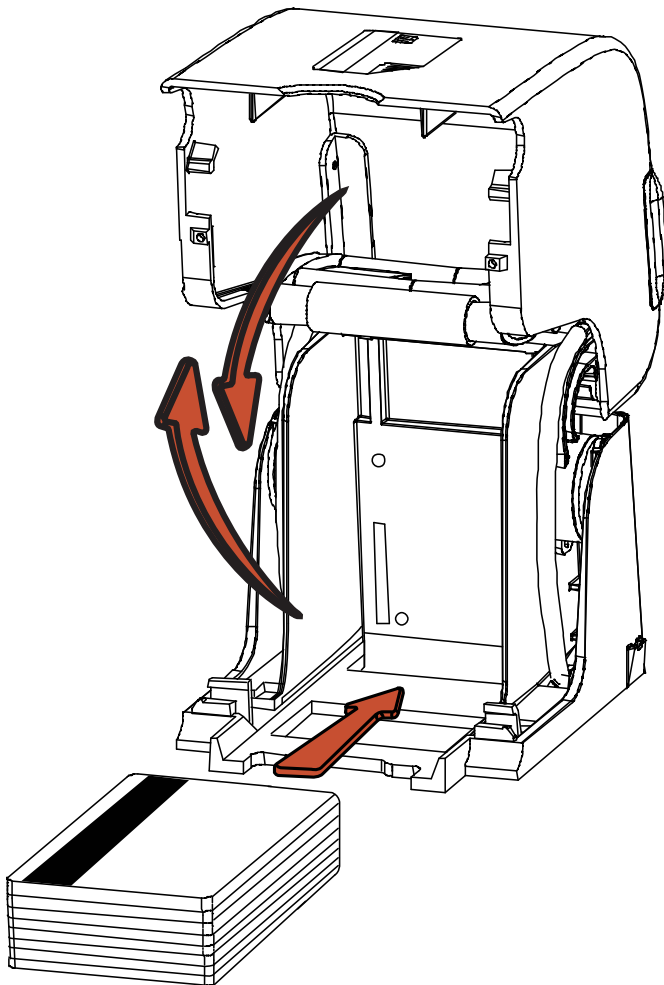

Loading the Blank Cards

Step	Procedure
2	Place the Card Input Cartridge onto the Printer until it clicks.

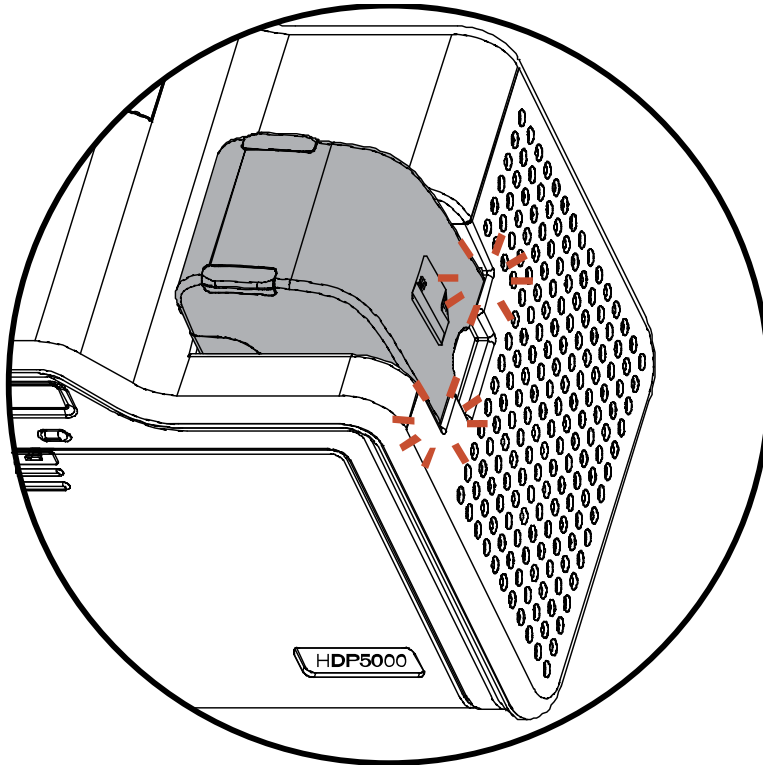

Connecting Power to HDP5000 Printer and Lamination Module



Caution: Do not plug in the USB cable until prompted to do so during the installation of the HDP5000 Printer Driver. Refer to the Driver installation procedure below.

Step	Procedure
1	The Printer and Lamination Module connections are shown in the Displays A to C
2	Use the same procedure for both the Printer and the Lamination Module. Power up the lamination module first then the printer. Note: If no Lamination Module is used then plug in the printer first.
3	IMPORTANT NOTE: After the printer and lamination module is connected to the power then the USB cable may be plugged into the computer. Do not connect the USB before the printer has been powered up.

Display A - Connecting the AC power cable to the power supply.



Connecting Power to HDP5000 Printer and Lamination Module

Display B - Connecting the other end of the AC power cable to a Surge Protector.

Note No. 1: Instead of connecting the AC power cable directly into an AC outlet, it is recommended that a Surge Protector be used to protect against power surges.

Note No. 2: Some buildings have surge protection built into the electrical outlets. Please consult your building supervisor regarding this feature.



Display C –

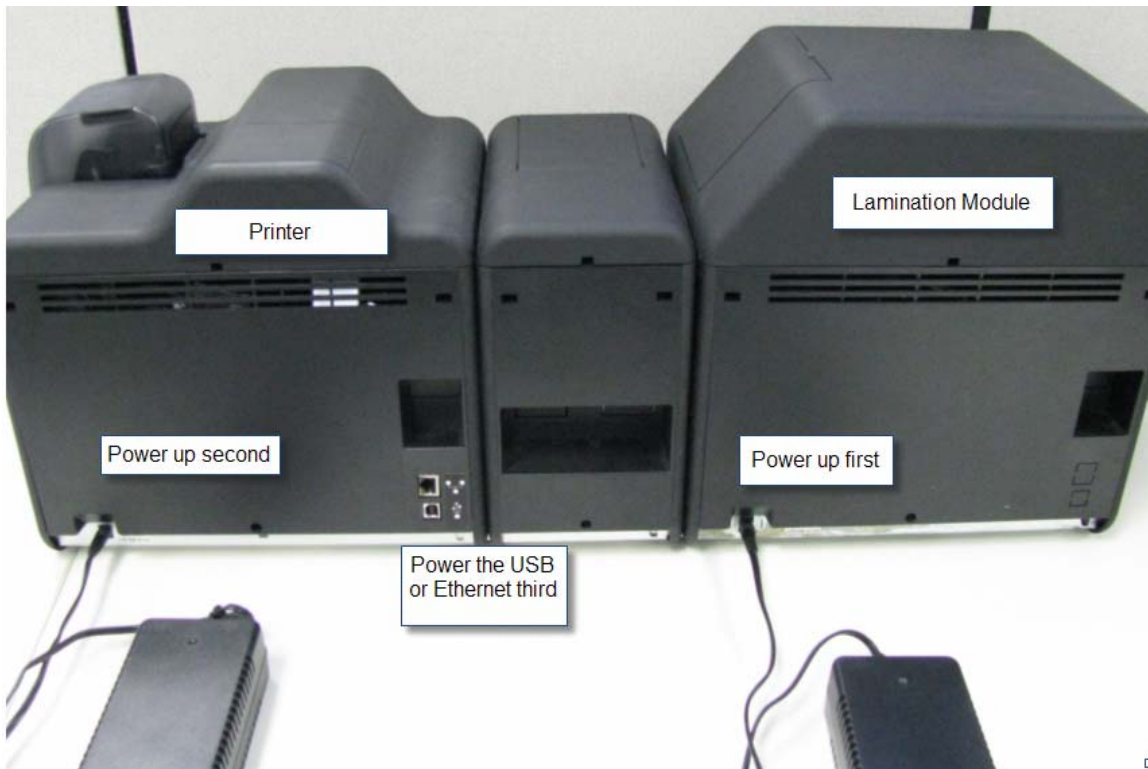

Printer Driver Installation Procedures

(For MAC OS X and Linux Driver and User Guide see www.hidglobal.com)

Installing the HDP5000 Printer Driver on Windows 2000/XP/2003

Step	Procedure
1	<p>Close down all programs and insert the Software Installation CD into your computer's CD drive. After a few seconds, the CD's installer program will automatically open.</p> <p>Follow the CD's on-screen Procedures to complete installation.</p> <p>(Note: If the CD does not automatically open, use "My Computer" or "Windows Explorer" to view the contents of the CD. Then, double-click on the Setup.exe file listed on the CD.)</p>
2	Click on the Next button to continue with the installation.

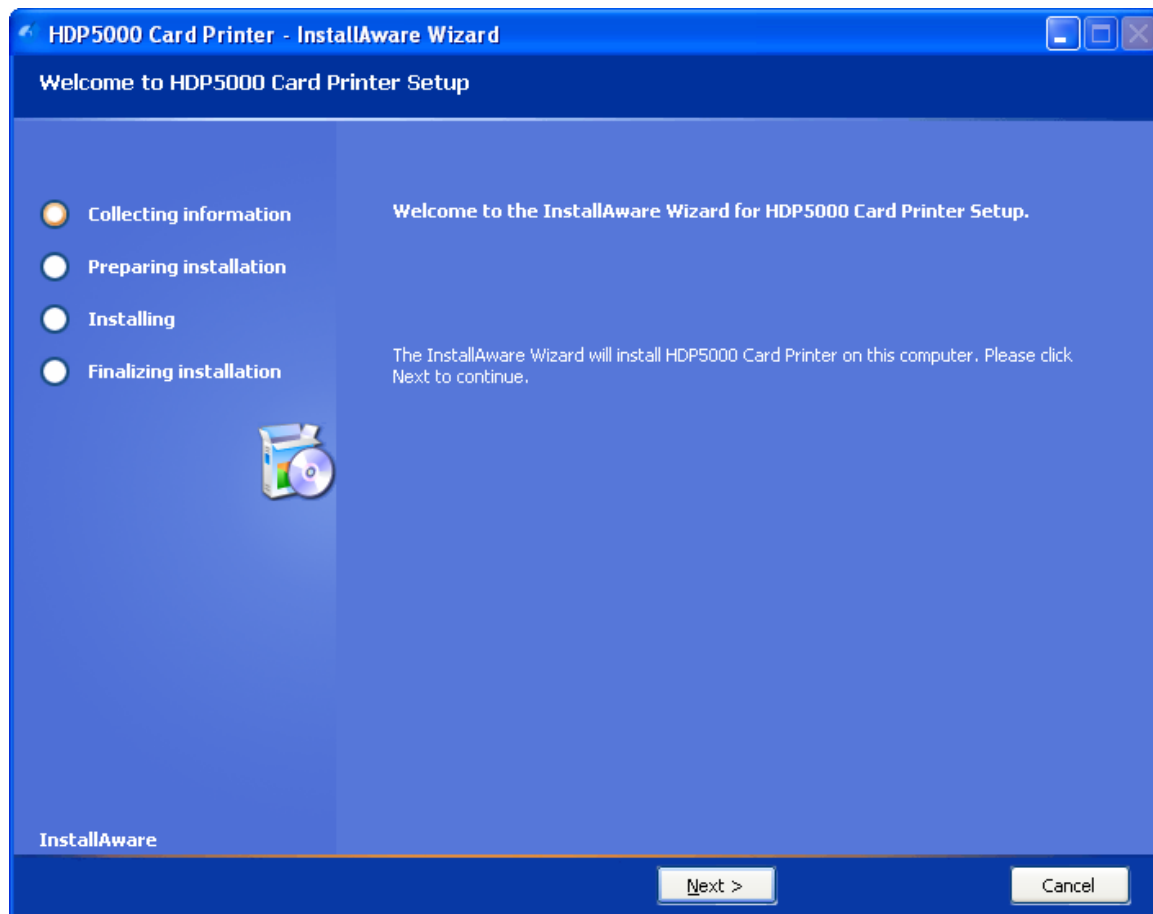

Printer Driver Installation Procedures

Step	Procedure
3	a. Read the License Agreement. Select the I accept the terms of the license agreement option. b. Click on the Next button to continue with the installation.

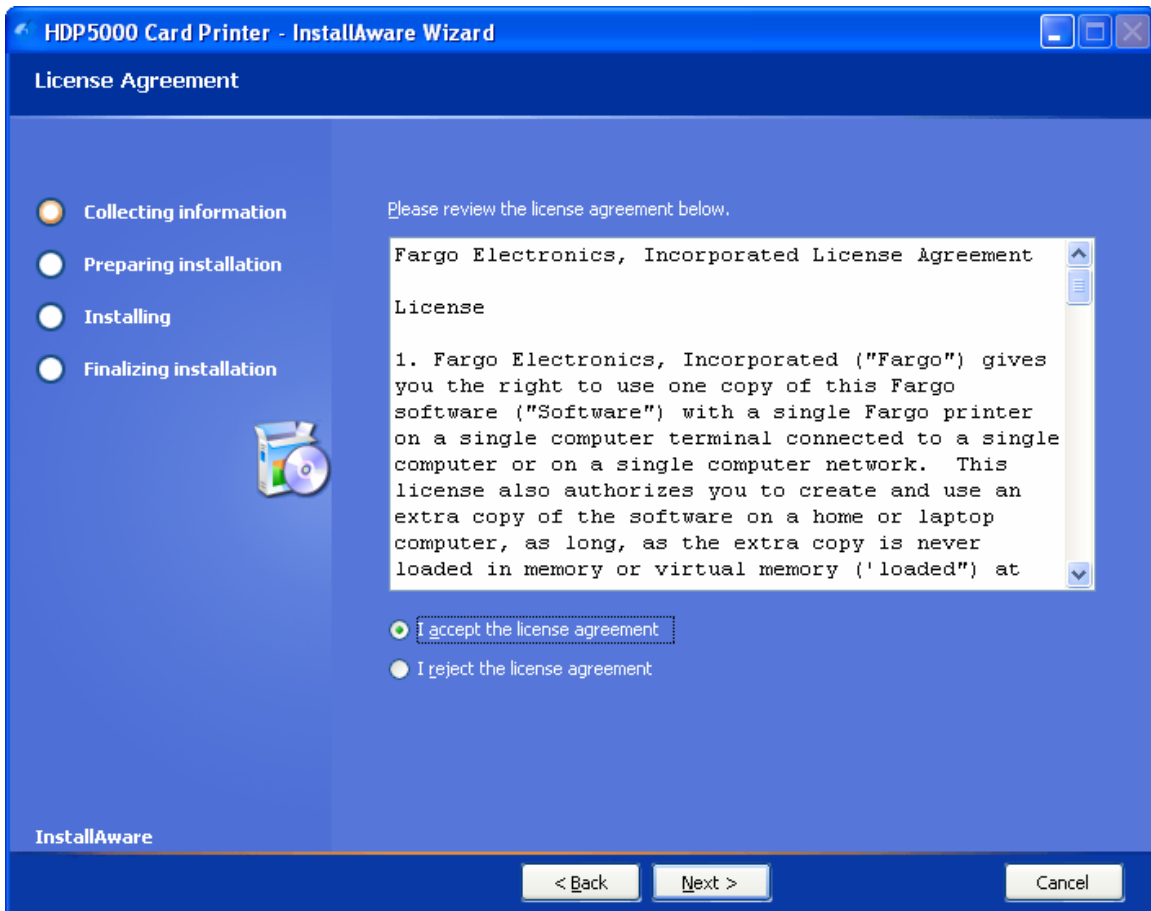

Printer Driver Installation Procedures

Step	Procedure
4	a. Select Local to install a USB Printer. OR b. Select Network and enter an IP Address for the Printer.

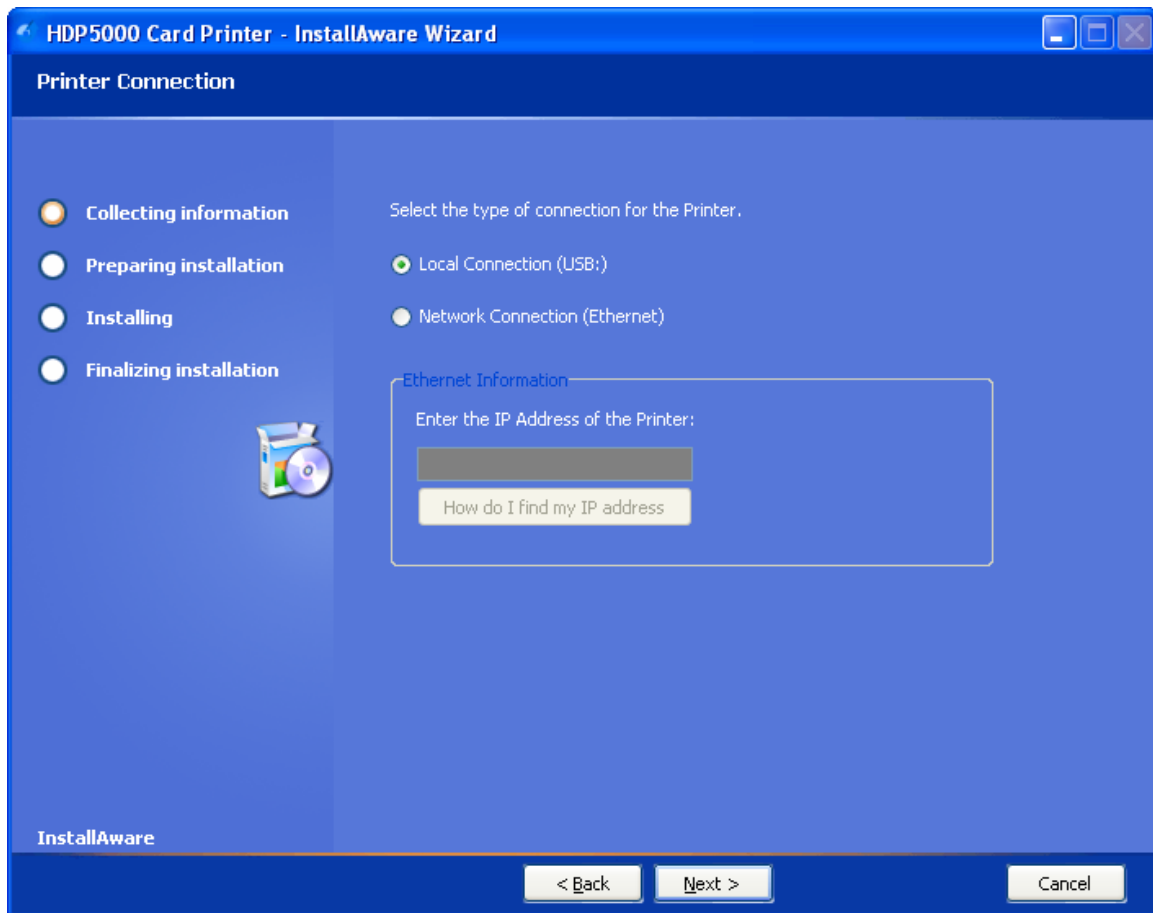

Printer Driver Installation Procedures

Step	Procedure
5	Click on the Next button to begin the installation.

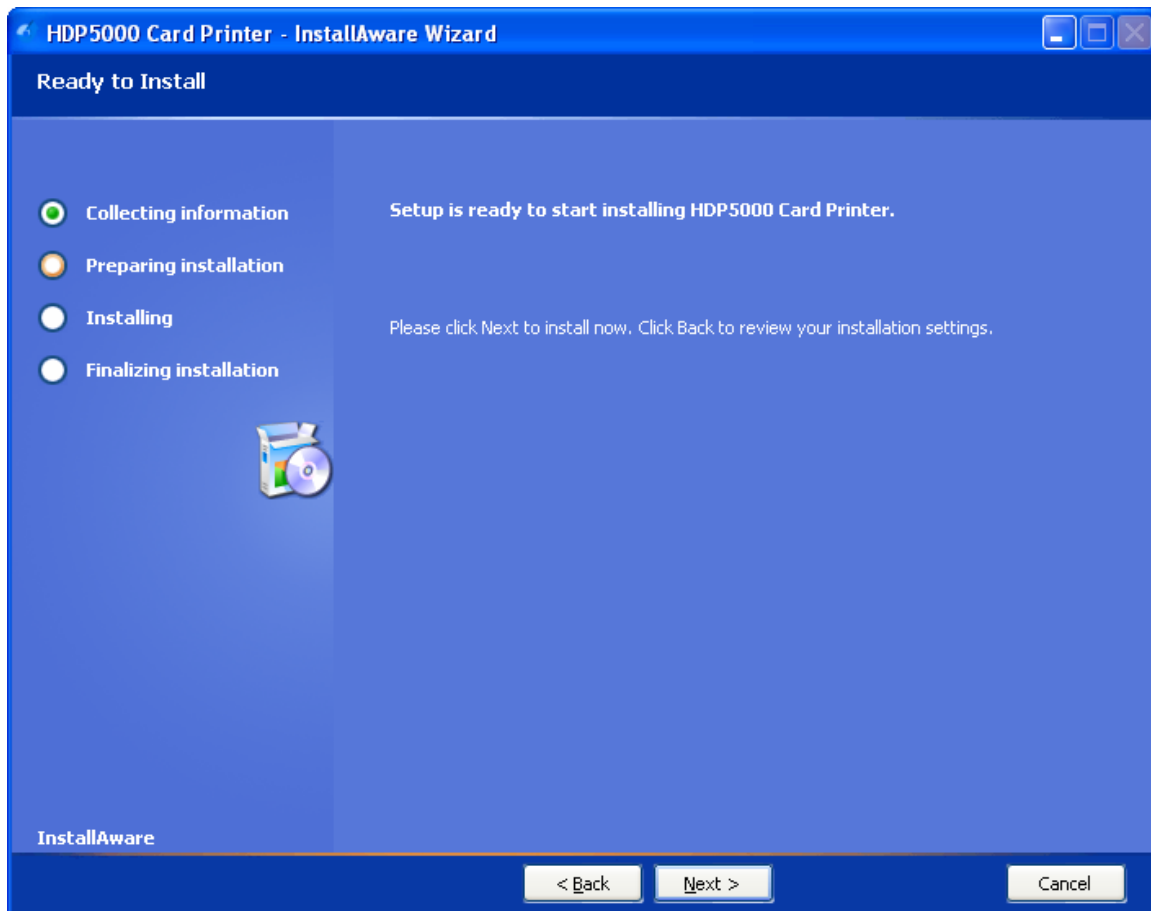

Printer Driver Installation Procedures

Step	Procedure
6	Wait during the installation.

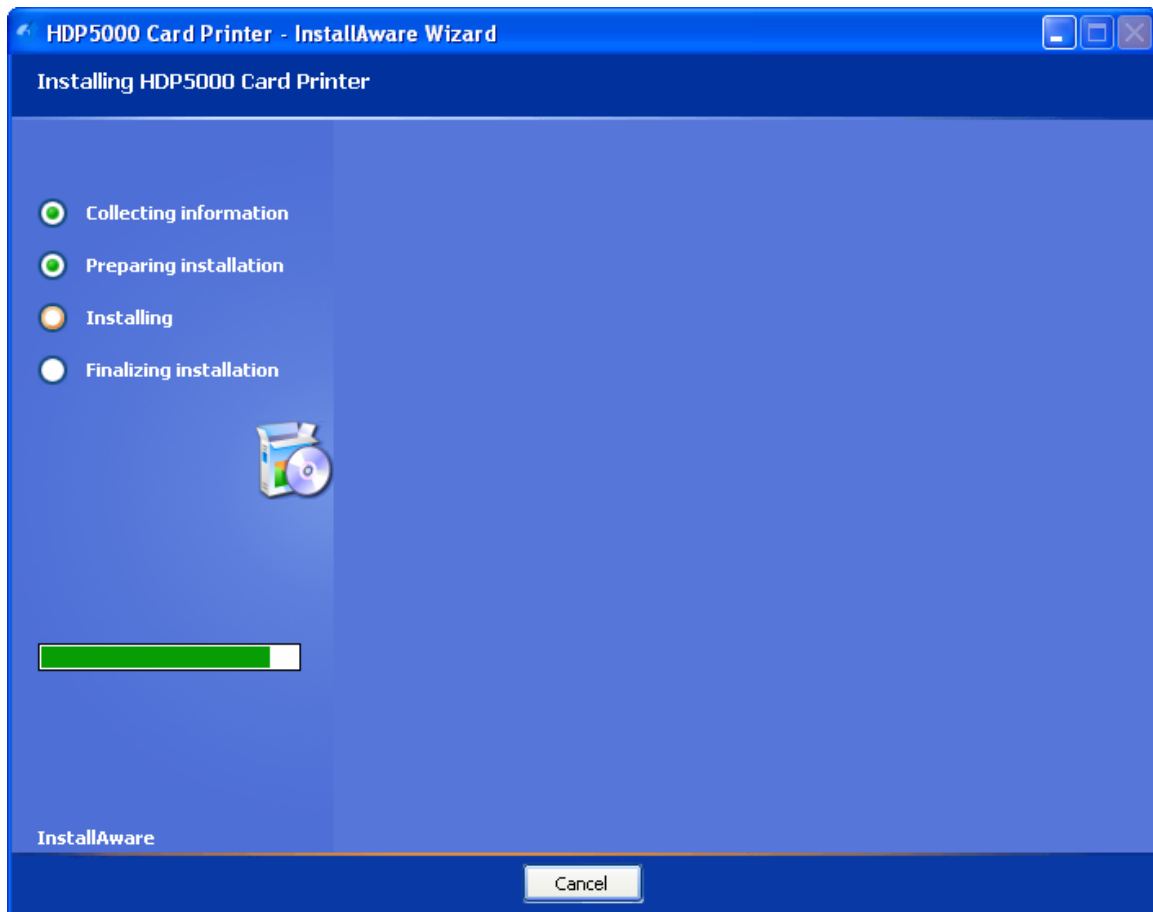

Printer Driver Installation Procedures

Step	Procedure
7	Applies to USB Printer installation: Connect the power to the printer. Connect the USB cable to both the PC and the Printer.

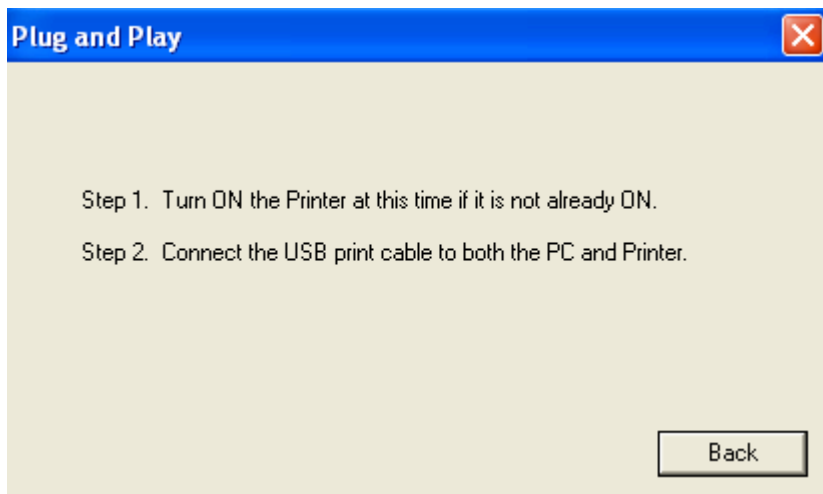

Printer Driver Installation Procedures

Step	Procedure
8	<p data-bbox="342 369 829 401">Applies to USB Printer installation:</p> <ol data-bbox="342 432 1317 579" style="list-style-type: none"><li data-bbox="342 432 1317 537">a. Select the Printer Port. (Note: You have the option of selecting the port only IF you click the BACK button from the previous screen shot; otherwise, this is automatic.)<li data-bbox="342 548 1203 579">b. Wait while the Driver components are being copied to your PC.

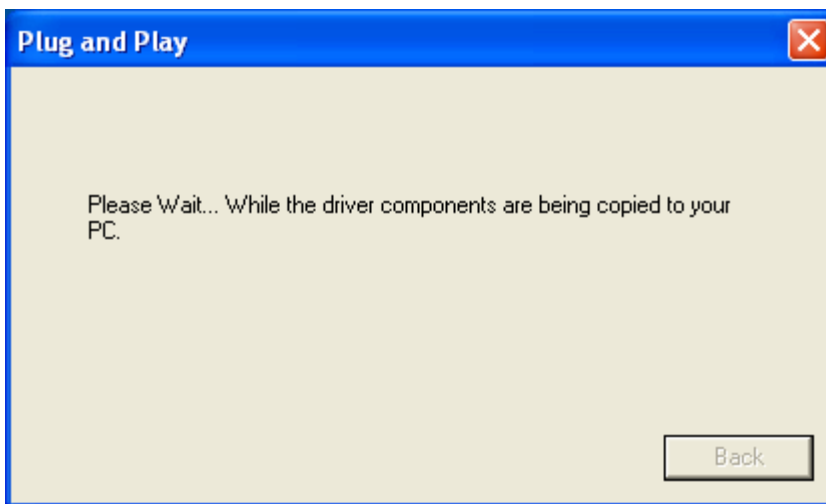

Printer Driver Installation Procedures

Step	Procedure
9	Click the Finish button.
10	Reboot your computer.
11	You have completed this procedure.

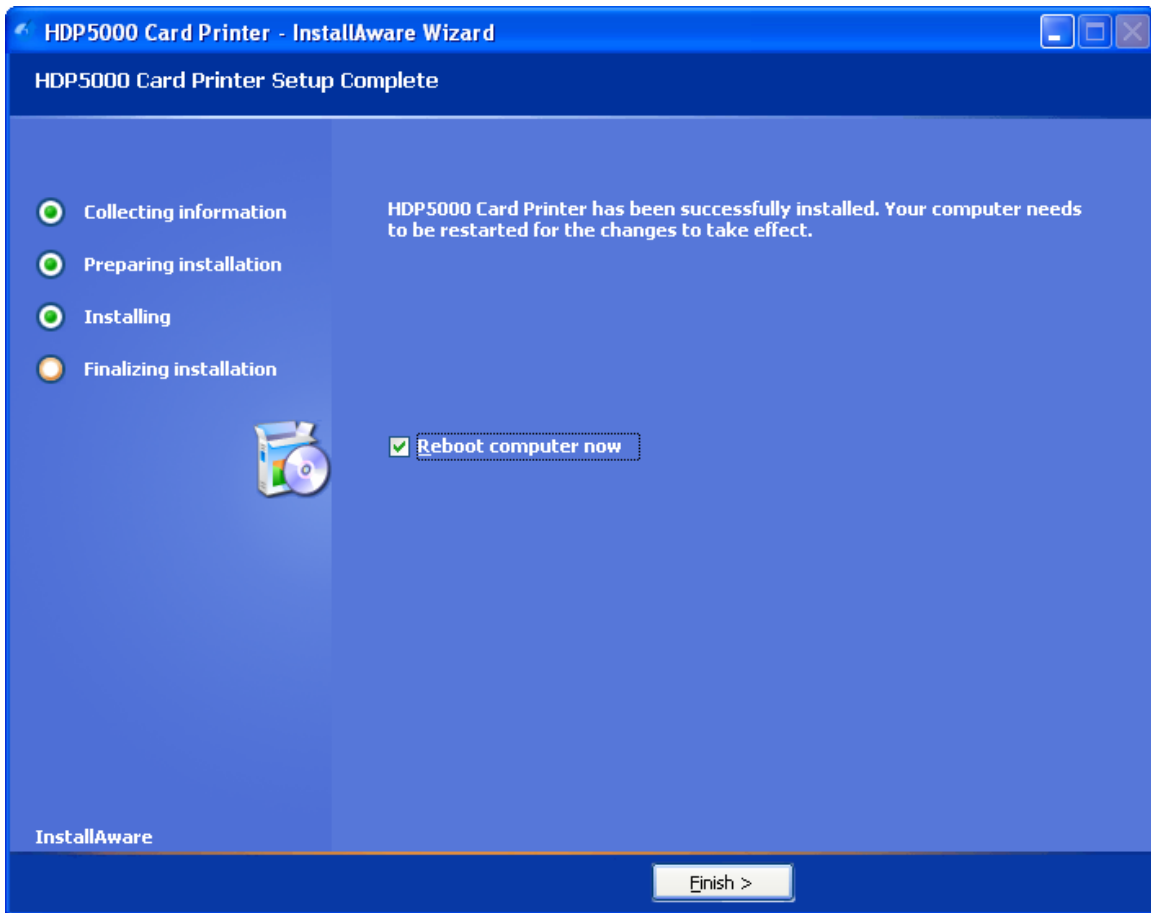

Printer Driver Update Procedure

Installing Printer Driver Updates

Occasionally, new Printer Driver versions are released which have new or updated features.

- Before installing an updated Printer Driver version, always delete the existing Printer Driver version from the system.
- To do this, select Start, Programs and point to the Fargo folder.
- Then, select the **Uninstall Printer Driver** icon for the specific Printer model (as shown here).

Step	Procedure
1	Once the existing Printer Driver is deleted, the updated version can be installed. (Note: The best way to get Printer Driver updates is to download them from the HIDGlobal website.)
2	<ol style="list-style-type: none"> To download the latest Printer Driver version, click on the Printer Driver's highlighted .exe file name on the web site. You will then be prompted to Save this program to disk. Fargo's downloadable Printer Driver files have names ending in .exe and are self-extracting Zip archives. (Note: A Zip archive is a package, containing one or more files. It has been zipped to make it smaller and provide easy downloading of numerous files simultaneously. An archive that is self-extracting is capable of unzipping itself.) Click OK, then choose the folder in which you would like to save the Printer Driver file. (Note: You may want to save it in an empty folder to prevent mingling its files with others already on the computer.) Once the file has completely downloaded to the computer, unzip the contents of the file by simply double-clicking on it. (Note: The archive will unzip itself, revealing its contents as a new list of files within the folder.)
3	To install, click the Start button, point to Settings and select Printers .
4	Double-click on the Add Printer icon.



Installing Printer Driver Updates

Step	Procedure
5	Follow the on-screen instructions to begin installation. See Printer Driver Installation . (Note: When prompted, click on the Have Disk button; the Install From Disk window will appear.)
6	Click on Browse , navigate to the folder containing the Printer Driver files you just downloaded and unzipped and click on OK . Click on OK again to close the Install From Disk window and then click on NEXT .
7	Follow the remainder of the on-screen instructions to complete installation. <ul style="list-style-type: none">• When prompted, do not have Windows print a test print.• This is because you most likely performed a Printer self test while you were setting up the Printer.• Once installed, the HDP Card Printer icon will appear in the Printer's folder.

Section 4: Printer Driver Operations

See this section for printer adjustments.

Safety Messages (review carefully)

Symbol	Critical Instructions for Safety purposes
<p>Danger:</p> 	<p>Failure to follow these installation guidelines can result in death or serious injury.</p> <p>Information that raises potential safety issues is indicated by a warning symbol (as shown to the left).</p> <ul style="list-style-type: none"> • To prevent personal injury, refer to the following safety messages before performing an operation preceded by this symbol. • To prevent personal injury, always remove the power cord prior to performing repair procedures, unless otherwise specified. • To prevent personal injury, make sure only qualified personnel perform these procedures.
<p>Caution:</p> 	<p>This device is electrostatically sensitive. It may be damaged if exposed to static electricity discharges.</p> <p>Information that raises potential electrostatic safety issues is indicated by a warning symbol (as shown to the left).</p> <ul style="list-style-type: none"> • To prevent equipment or media damage, refer to the following safety messages before performing an operation preceded by this symbol. • To prevent equipment or media damage, observe all established Electrostatic Discharge (ESD) procedures while handling cables in or near the Circuit Board and Printhead Assemblies. • To prevent equipment or media damage, always wear an appropriate personal grounding device (e.g., a high quality wrist strap grounded to avoid potential damage). • To prevent equipment or media damage, always remove the Ribbon and Cards from the Printer before making any repairs, unless otherwise specified. • To prevent equipment or media damage, take jewelry off of fingers and hands, as well as thoroughly clean hands to remove oil and debris before working on the Printer.

HDP500 Printer Driver Options

Reviewing Printer Drivers

The window title reflects the specific Printer Driver in use as shown in this introductory section.

Using the Card tab

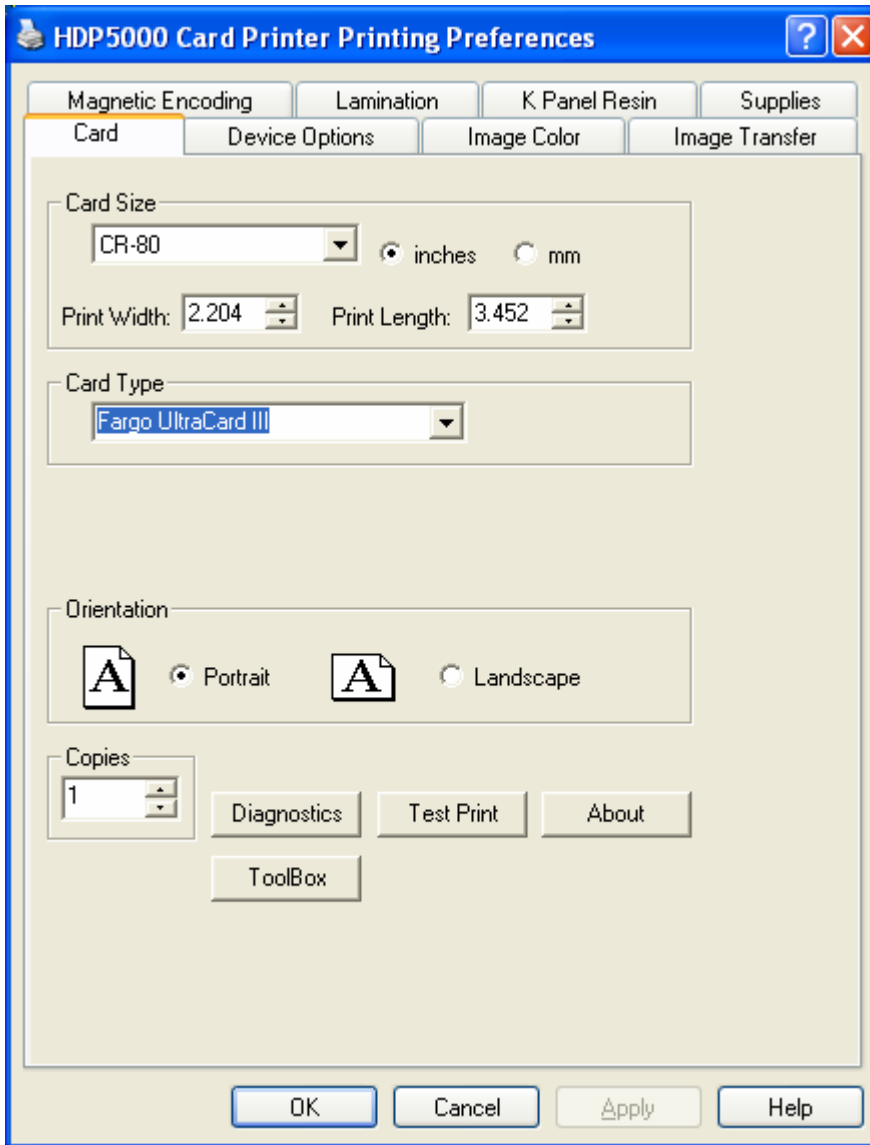

Selecting the Card Size

Step	Procedure
1	<p>Select the appropriate card option:</p> <ul style="list-style-type: none"> • CR-80: This selection is the default form size for the HDP5000. This will print a 2.125 X 3.374 image including a .04 over-bleed on each of the 4 sides making the overall form size 2.204 X 3.452 (56 X 87.7 mm). • Custom: This selection is used to create a custom form size from 1.0 x 3.0 to 2.204 to 3.452 (25.4 X 76.2 mm to 56 X 87.7 mm). <p>The dimensions of the total print area for each card size will appear in the Print Width and Print Length boxes.</p> <ul style="list-style-type: none"> • These print area dimensions are .04" (1mm) larger than the actual card size. This is so the Printer can overprint images to ensure they will appear Edge-to-Edge when transferred to the card. • For this reason, when designing a card format, always set the card size or page size within the card design program to the exact Print Length and Width dimensions listed in the Printer Driver.)

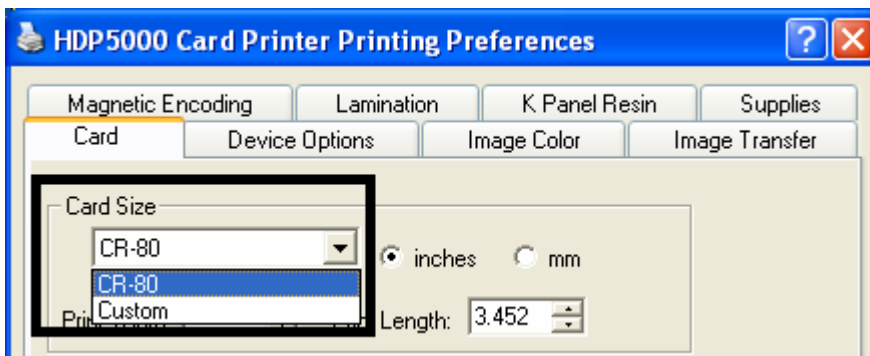

Selecting the Card Type

Select the appropriate card type according to the composition of the card stock.

Step	Procedure
1	<p>You have these selections (to choose from):</p> <ul style="list-style-type: none"> • Fargo UltraCard Premium III (Default Card Type) • Fargo Ultracard • HID Tech Card Composite • HID Tech Card PVC • Indala FlexISO – Standard (FPISO) • Indala FLexISO XT-Composite (FPIXT) • Custom 1 • Custom 2 • Defaults: The HDP Printer Driver software has default Transfer Temperature and Dwell Time settings that deliver the best transfer for these card types. These defaults automatically configure based on the card type, Ribbon type and whether printing single- or dual-sided. • Card Type Selection: Before printing, if using these standard Fargo card types, check to make sure that the appropriate card type option selected from the Card tab of the HDP Printer Driver: • Proper Settings: It is very important to note that not all card types will be accommodated by these default settings. In some cases, experimentation may be needed to find the proper settings. <p> Caution: If the appropriate option is not selected, the wrong Dwell Time and temperature may be used during the image transfer process, which may result in poor adhesion of the HDP Film or warping of the card.)</p>

Selecting the Card Type

Step	Procedure
2	<p>If using a card stock other than listed, use the Custom 1 options to save custom Dwell Time and dwell temperature controls on the Image Transfer tab.</p> <ol style="list-style-type: none"> Click on the Custom options and enter a name for the card stock. Click on the Image Transfer tab to adjust the Dwell Time and temperature sliders to the appropriate settings. See the next page. (Note: These settings will be saved for the custom card type when the Printer Driver setup window is closed.) Custom Card stock: To determine the proper settings for custom card stock, apply the Tape adhesion Test. Conducting the Tape Adhesion Test

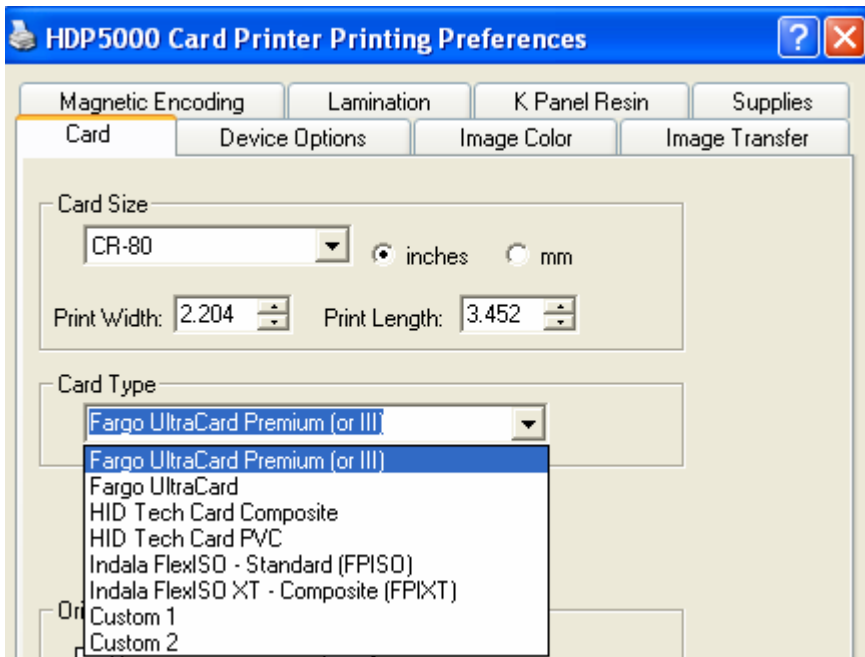

Selecting the Card Type

Please see Step 2b on the previous page.

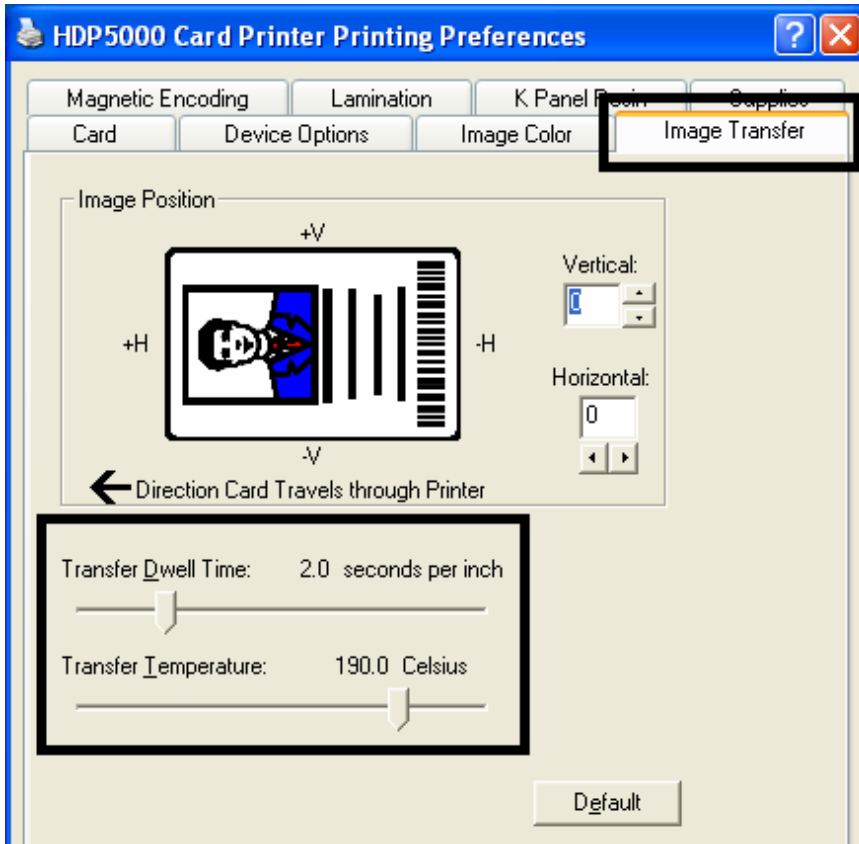

Setting the Orientation

Select either the **Portrait** or **Landscape** radio buttons for Orientation.

Step	Procedure
1	Select Portrait to cause the card to print in a vertical orientation. OR Select Landscape to cause the card to print in a horizontal orientation.

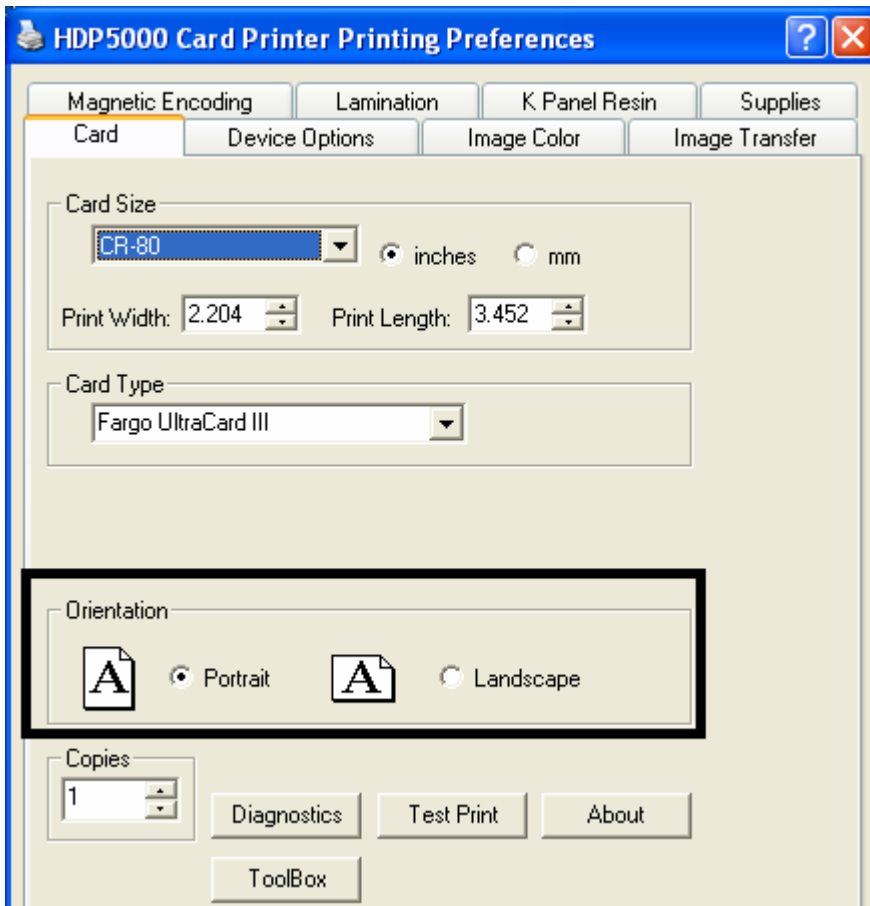

Specifying the number of Copies

Specifies the number of copies to be printed.

- The upper limit is 10000 and the lower limit is 1.

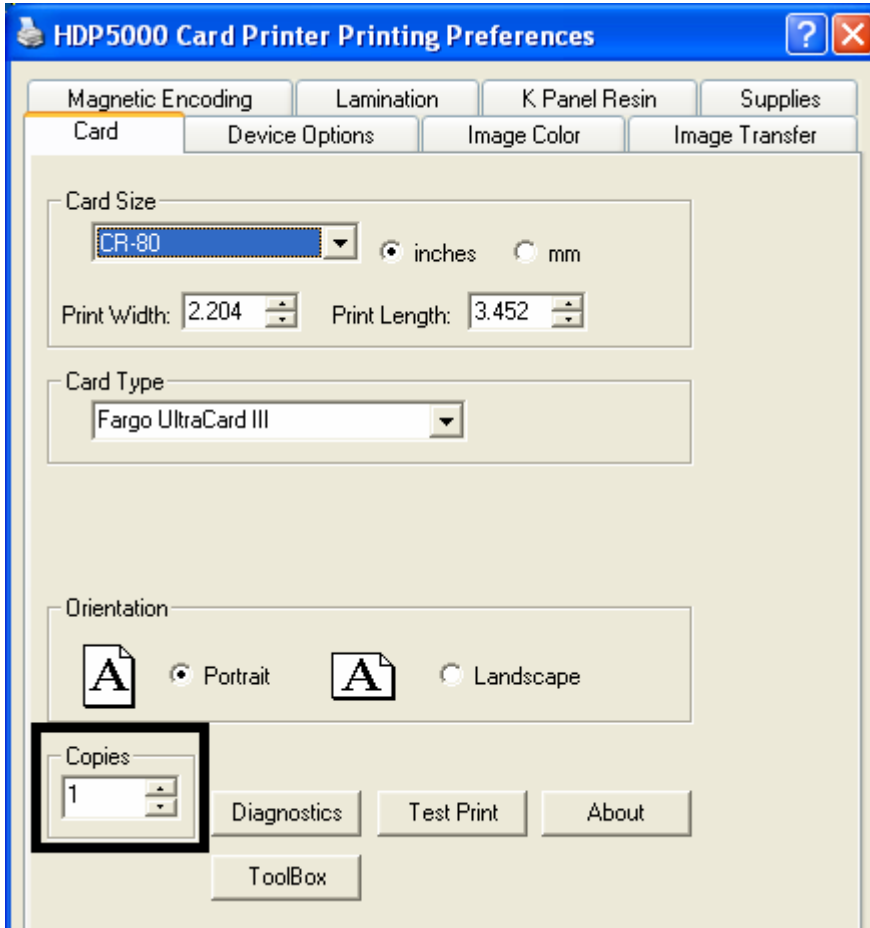

Selecting the Diagnostics button

This will launch the Diagnostic tool (if installed).

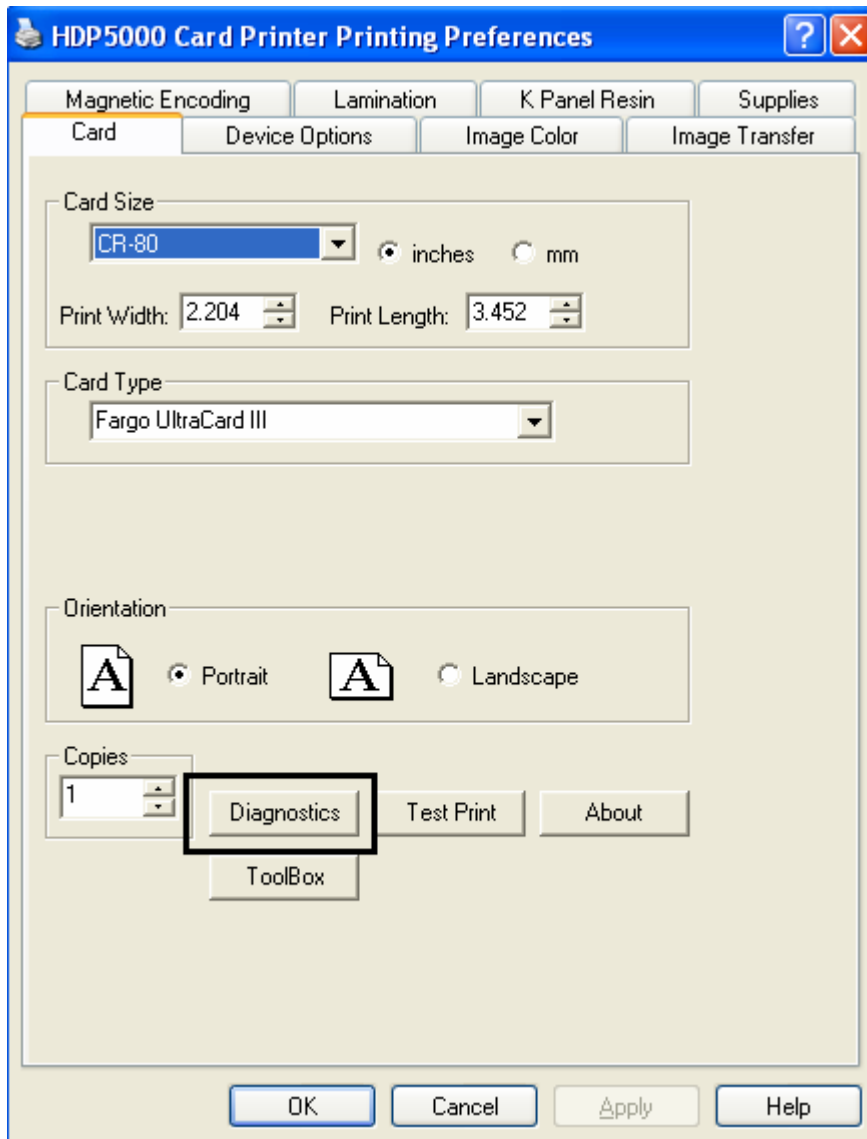

Printing a Test Print Image

Step	Procedure
1	Install a HDP5000 compatible ribbon in the Printer for the Test Print.
2	Open the Driver settings. <ol style="list-style-type: none">From your computer's startup menu, select Settings > Printers and Faxes (Windows XP) or > Printers (Windows 2000).Double click on the HDP5000 Card Printer under the Printer's window.Select Printing Preferences under the Printer drop-down menu. (Note: This will bring up the HDP5000 Printing Preferences window.)
3	<ol style="list-style-type: none">Select the Card tab, and then click on the Test Print button, as shown in Display A on the next page.When the Test Print button is selected, an image is copied to the Printer.
4	This completes the HDP5000 High Definition Card Printer/Encoder Installation Guide.

Printing a Test Print Image

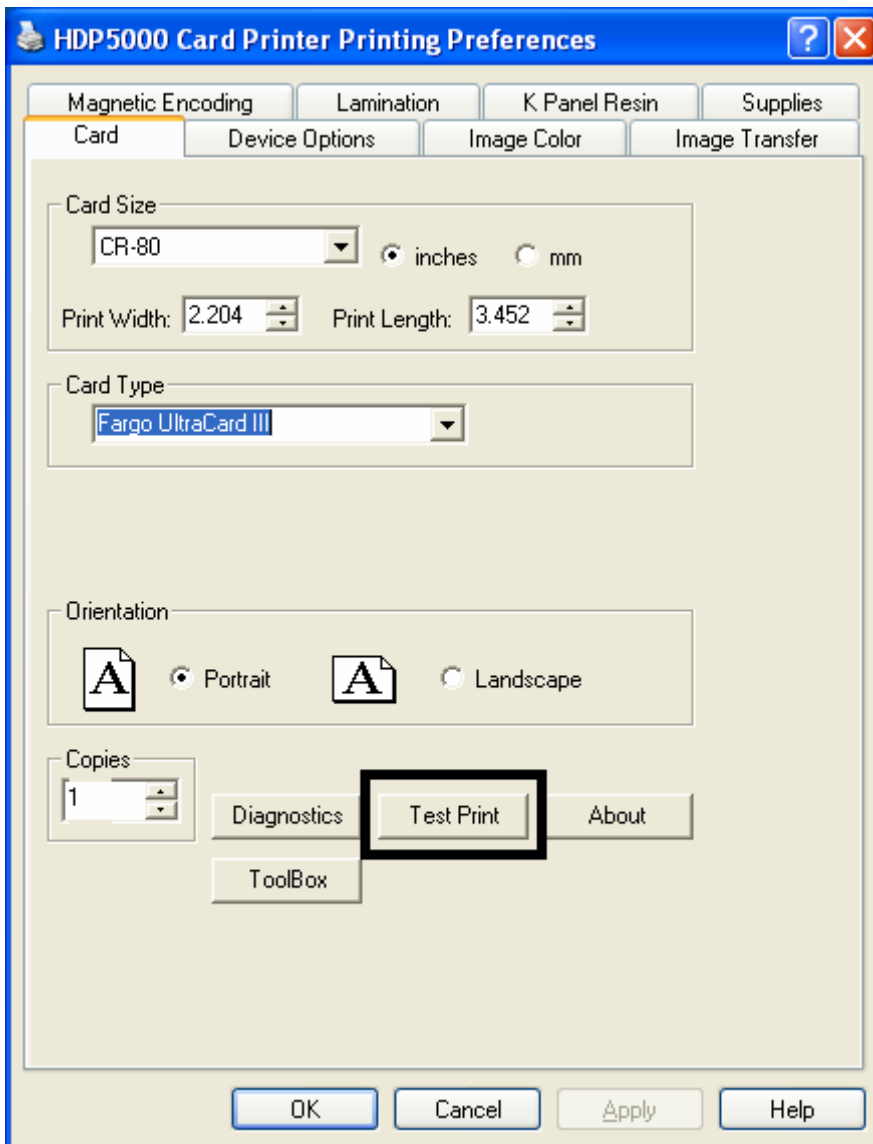

Selecting the About button

Select the **About** button to open a dialog box containing the copyright information as well as the Driver's version number and date code.



Selecting the Toolbox button

Select the **Toolbox** button. See the [Toolbox](#) HELP section for more information and procedures..

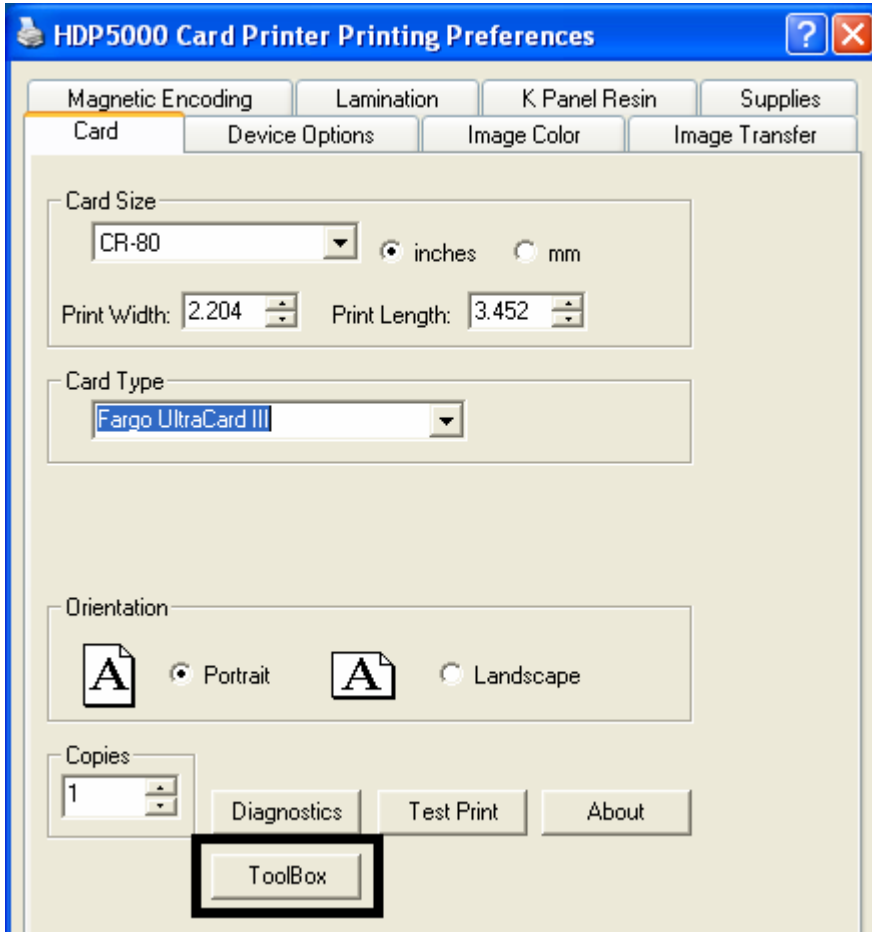

Using the Device Options tab

This section describes the use of the Device Options tab.

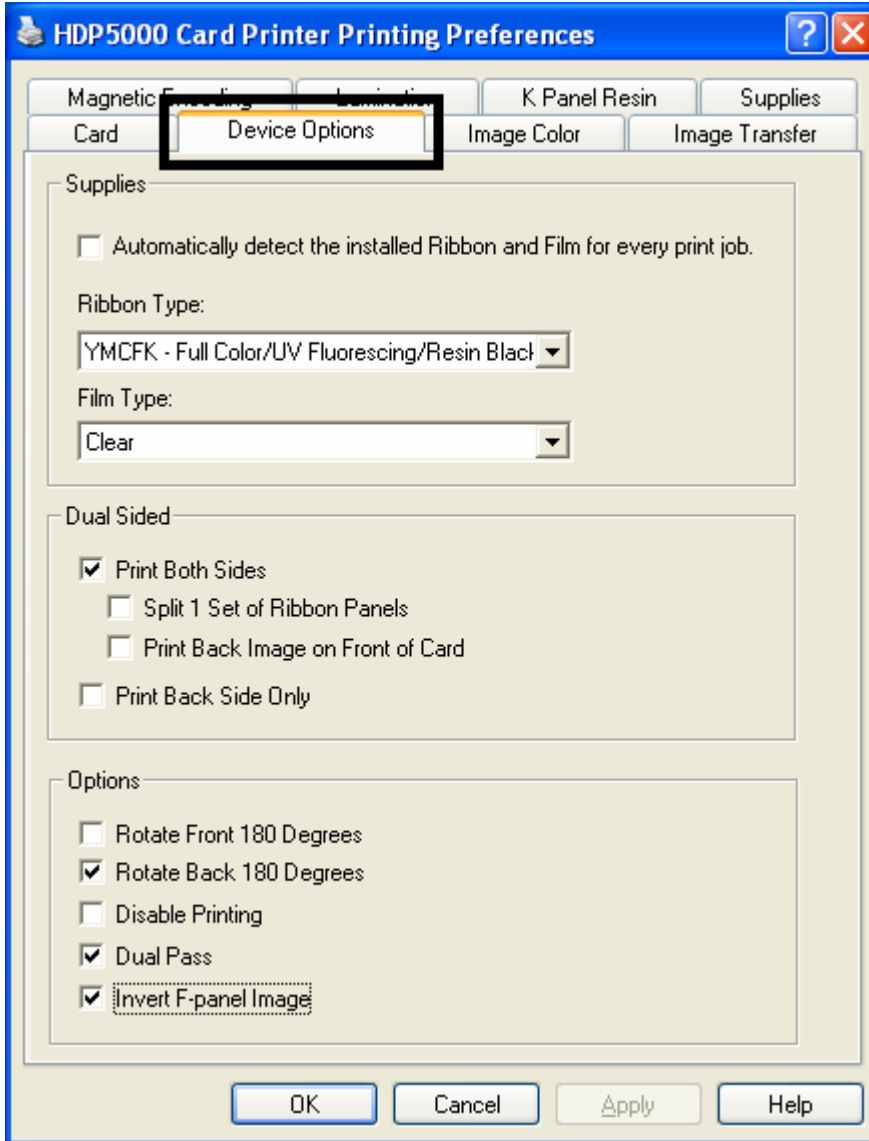

Detecting Supplies at Print Time Function

Step	Procedure
1	<p>Use the Supplies checkbox for auto detection of the consumables, which are the Ribbon, Film and Laminate. See below.</p> <ul style="list-style-type: none"> In the Firmware, the values (representing the installed Ribbon, installed Transfer Film and installed Laminate) are updated on initialization (including each time the cover is closed). The Firmware compares the Ribbon, Film and Laminate values in the PRN file to the values (it holds regarding the currently installed consumables). <p>If the values do not match, the LCD displays Wrong Ribbon Error, Wrong Film Error, or Lam1 or 2 Wrong Film Error and the Driver returns the corresponding error message. See below.</p>
2	<p>The following information applies to the Supplies checkbox.</p> <ul style="list-style-type: none"> Laminator (installed): The Driver automatically detects the installed Ribbon, Film and Laminate for every print job. No Laminator (installed): The Driver automatically detects the installed Ribbon and Film for every print job.

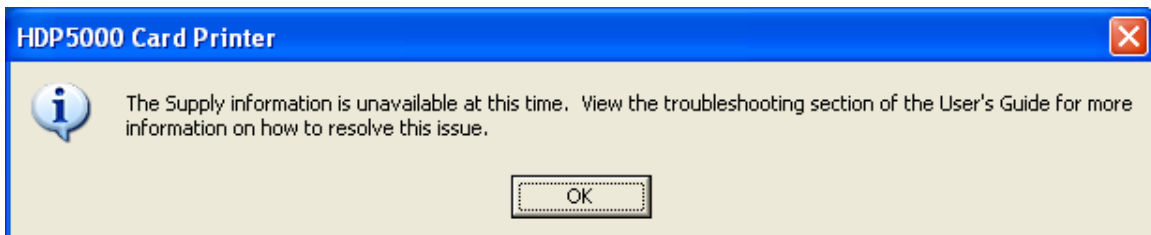
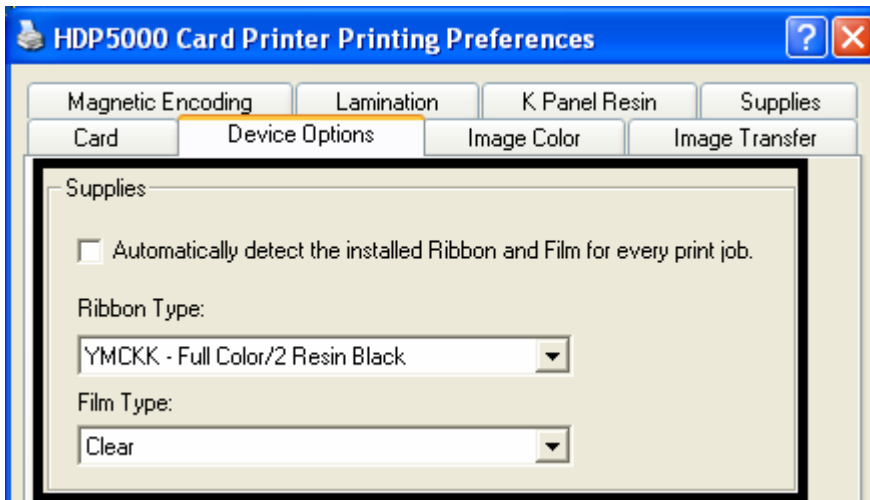

Detecting Supplies at Print Time Function

Step	Procedure
3	<p>When the Supplies checkbox is checked, the following takes place:</p> <ul style="list-style-type: none"> Ribbon and Film Type dropdown boxes are inactive and populated with values of installed supplies. Dual Sided and Options are set to defaults for detected supplies. For example, no Dual Side options are available when no Flipper is installed. This function provides automatic detection of an installed feature whether it is automatically detecting supplies or not. Before the Driver initiates each job, it retrieves the consumables values from the Firmware. If no Printer is found or no Ribbon is installed, the checkbox is allowed to be checked. (Note: The previously-chosen Ribbon and Film values will remain. You will see an error message.) Activating the Device Options tab automatically repopulates the Ribbon and Film types. (Note: You will see an error message if no Printer found when activating the Device Options tab.)

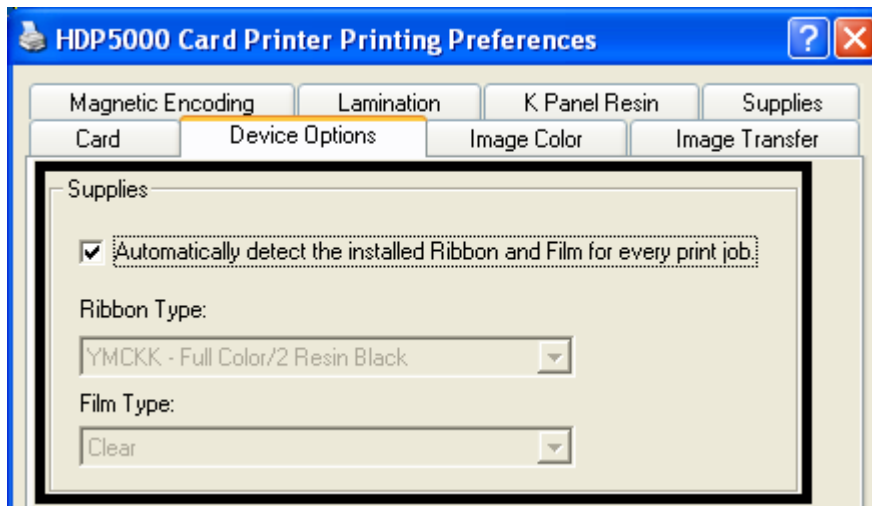

Detecting Supplies at Print Time Function

Step	Procedure
4	When the Supplies checkbox is not checked or it is de-selected (cleared) from a selected state, the Ribbon and Film dropdown boxes become active and auto selected Ribbon and Film types remain (until manually changed).

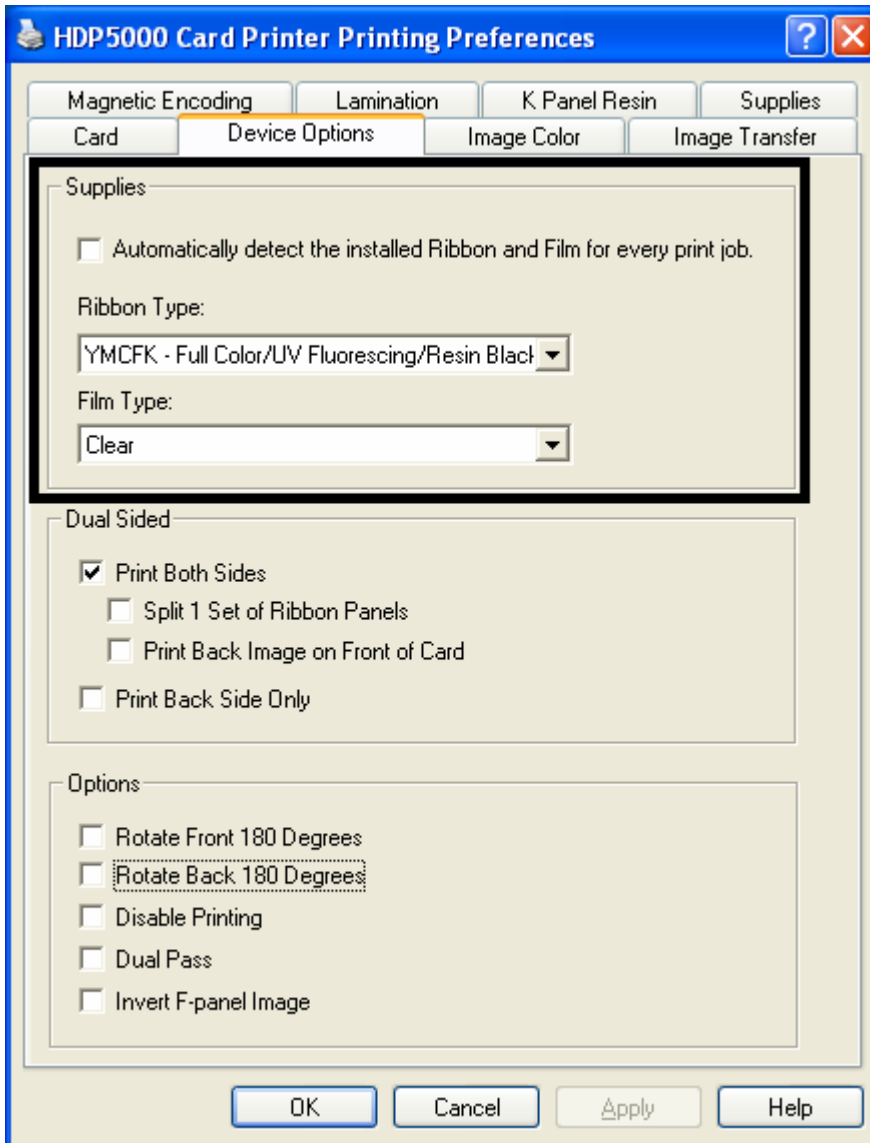

Adjusting the Ribbon Type

Use the Ribbon Type dropdown menu to match Ribbon type.

Step	Procedure
1	<p>Adjust to match the Ribbon Type selection with the Ribbon type that is loaded in the Printer.</p> <ul style="list-style-type: none"> • YMC (Full Color): Yellow, Magenta, Cyan OR • YMCK (Full Color/Resin Black): Yellow, Magenta, Cyan, Resin Black OR • YMCKK (Full Color/2 Resin Black): Yellow, Magenta, Cyan, Resin Black, Resin Black OR • YMCKH (Full Color/Resin Black/Heat Seal): Yellow, Magenta, Cyan, Resin Black, and Heat Seal OR • YMCFK (Full Color/Resin Black/Fluorescing): Yellow, Magenta, Cyan, UV Fluorescing, and Resin Black • YMCKI (Full Color/Resin Black/Inhibit): Yellow, Magenta, Cyan, Resin Black, Inhibit • K Premium Resin

Adjusting the Ribbon Type

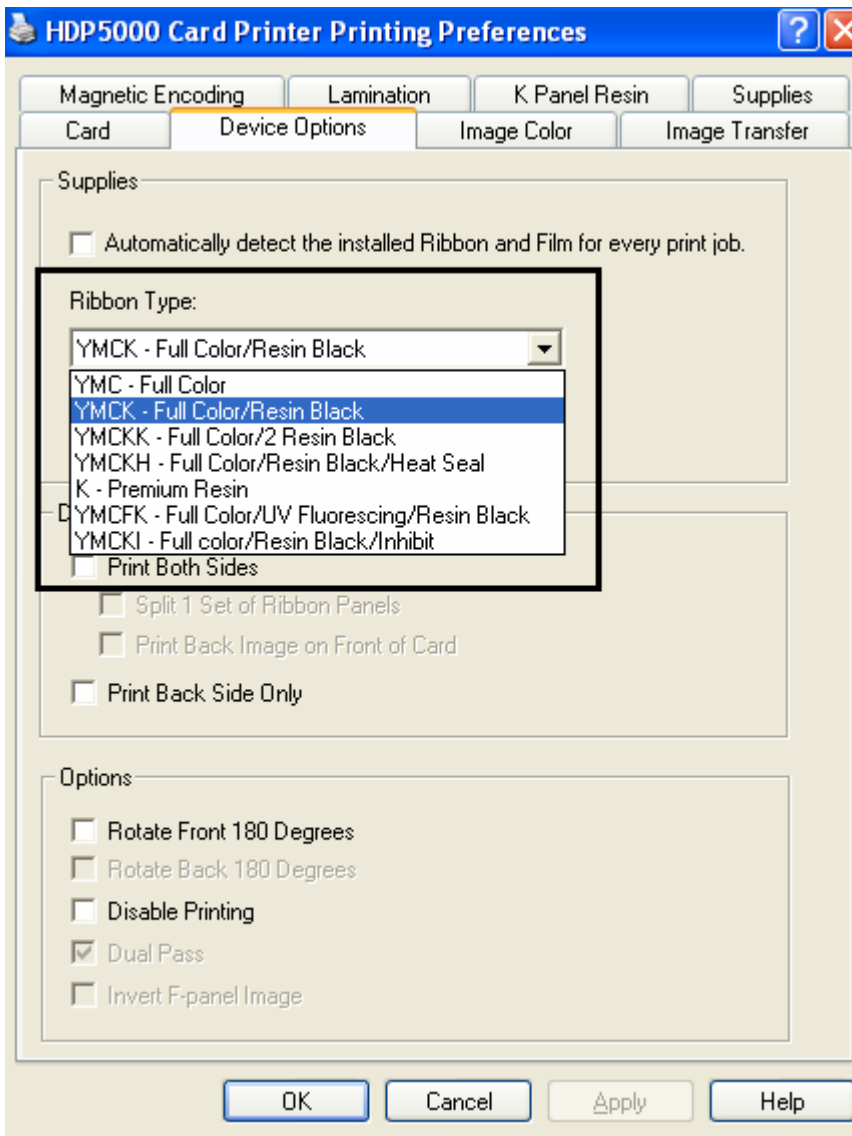

Adjusting the Film Type

Step	Procedure
1	<p>Allows you to select the film type option that is appropriate for the type of HDP film currently loaded in the Printer.</p> <ul style="list-style-type: none"> Select the Clear option to automatically adjust the appropriate transfer time and temperature to pre-determined defaults. (Note: Select this option to automatically adjust the transfer temperature (175.0 Celsius) and the dwell times (2.0 seconds per inch) to defaults when non-custom card type is chosen on Card tab.) <p>OR</p> <ul style="list-style-type: none"> Select the Holographic option to change appropriate internal Printer settings needed to make the holographic film work. (Note: Select this option to automatically adjust the transfer temperature (175.0 Celsius) and the dwell times (2.0 seconds per inch) to defaults when non-custom card type is chosen on Card tab.) <p>(Note: It will also adjust the necessary transfer temperature and the dwell settings in the Driver to provide the optimal holographic InTM performance.)</p>

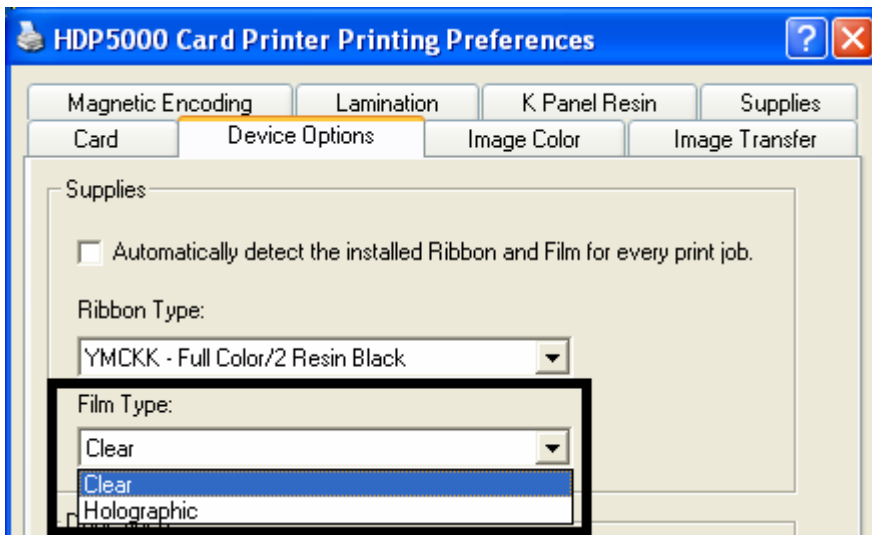

Using the Dual Sided Group Functions

The Dual Sided group checkboxes (shown below) are grayed out if no Flipper is automatically found or if the Dual Sided is manually turned off. See the procedures in this section for more instructions.

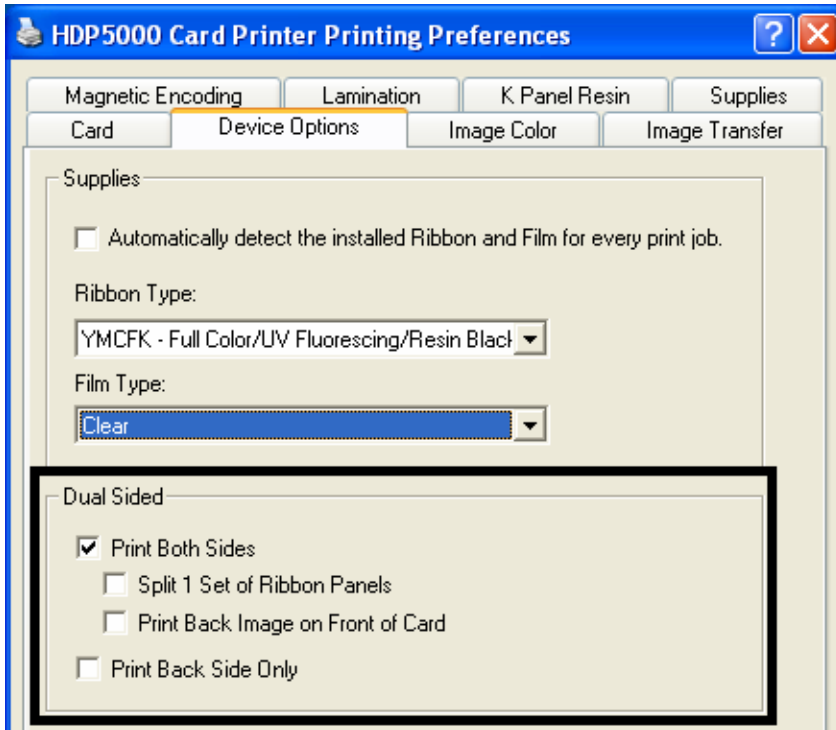

Using the Dual Sided - Print Both Sides option

Use this option to automatically print on both the front and backside of a card.

Step	Procedure
1	Select this option in conjunction with any application program that supports a multiple-page document, duplex printing. (Note: The program must be able to send down two or more separate pages to be printed within the same document.)
2	<ul style="list-style-type: none">• Page 1 will be transferred to the front side of the card.• Page 2 will be transferred to the backside of the card.• The Printer Driver will always place all odd numbered pages on the front side of the card and all even numbered pages on the back side with this option selected.

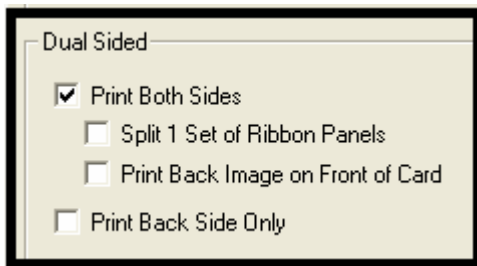

Using the Print Both Sides - Split 1 Set of Ribbon Panels option

Use this option to provide the most economical means of printing a dual-sided card since a single set of Ribbon Panels will be split to print both the front and backside of a card.

- This option becomes active when **Print Both Sides** is checked.
- The Default is active and unchecked except for YMCKK, which is checked.

Step	Procedure
1	<p>Select this option to automatically print full-color on the front of a card and resin black on the back of a card (using YMCKK Print Ribbons).</p> <ul style="list-style-type: none"> • If using a YMCKK Ribbon, the front of the card is printed with the YMCK Panels and the back is printed with the second K Panel. <p>(Note #1: This option is automatically enabled when a YMCKK Ribbon type is selected.)</p> <p>(Note #2: This option is not available if using a YMCKH Ribbon.)</p>

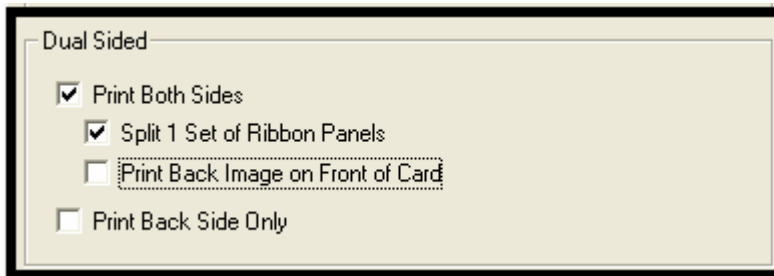

Using the Print Both Sides - Print Back Image on Front of Card option

This option becomes active when **Print Both Sides** is checked. The Default is active and unchecked.

Step	Procedure
1	<p>Select this option:</p> <ul style="list-style-type: none">• If you need to print the first page of a two-page document on the backside of the card. <p>OR</p> <ul style="list-style-type: none">• If you need to print the resin black on the chip-side of the Smartcard. <p>The second page of the document will be printed on the front side of the card.</p>

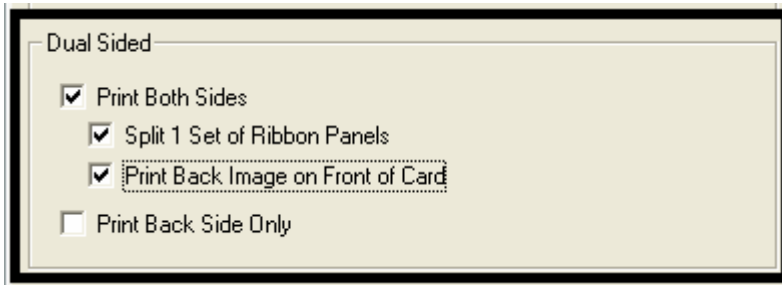

Using the Dual Sided - Print Back Side Only option

Use this option to print only onto the backside of cards. (**Note:** The **Print Back Side Only** checkbox default is active and unchecked.)

Step	Procedure
1	<p>Select this option to print only onto the backside of preprinted cards that must have their Magnetic Stripe or smart card chip encoded. (Note: Load the cards in the usual fashion.)</p> <ul style="list-style-type: none">• When this option is selected, the Print Both Sides option is automatically disabled.)• When attempting to print a two-page document (if Print Back Side Only is selected), the first page of the document will print on the backside of the card.• The second page of the document will then be printed on the back of a second card.

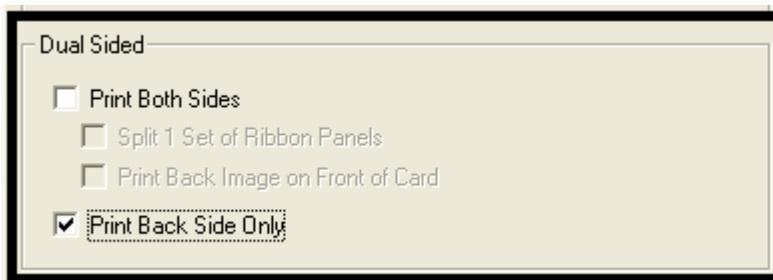

Using the Options Group

The functions under the Options Group are described in this section.

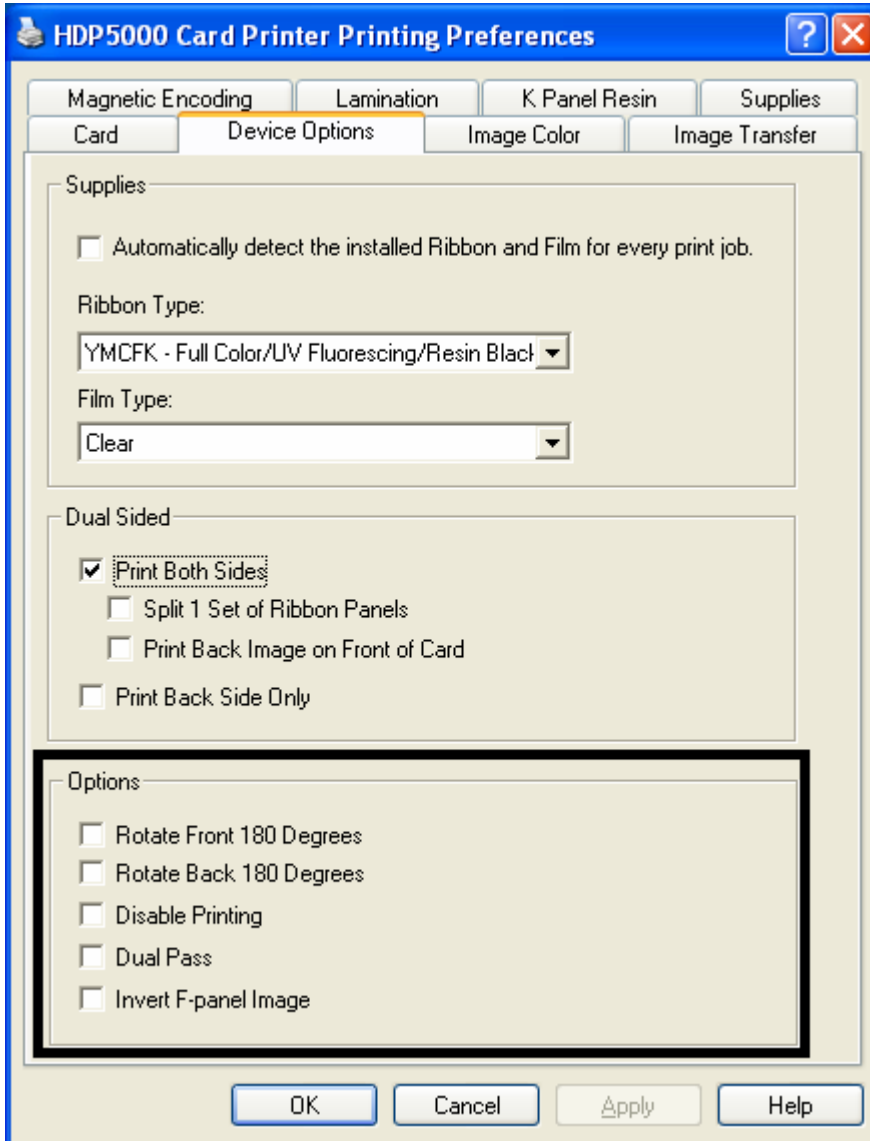

Using the Rotate Front 180 Degrees or Rotate Back 180 Degrees options

Use this option to change the position of the printed image in relation to the set location of a card's Magnetic Stripe or smart chip.

Step	Procedure
1	Select the Rotate Front 180 Degrees option to rotate the image on the front of the card by 180 degrees when printed. OR Select the Rotate Back 180 Degrees option to rotate the image on the back of the card by 180 degrees when printed.

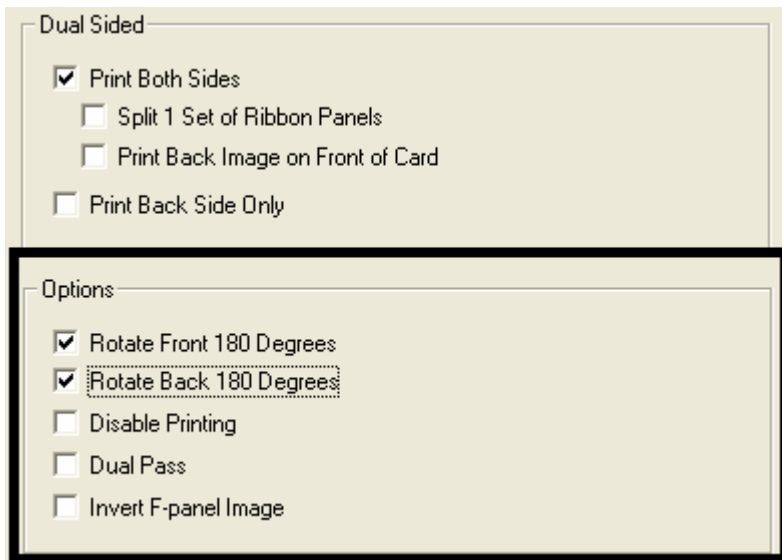

Using the Disable Printing option

Use this option to disable the printing capabilities of the Printer while still allowing the Printer to encode cards. (**Note:** This option is useful to encode or re-encode preprinted cards without wasting additional time or printing supplies.)

Step	Procedure
1	Select this option to ensure no print data will be sent to the Printer (while all encoding instructions will be sent according to how they are configured within the software). This option also allows you to laminate the card.



Using the Dual Pass and Invert F-Panel Image options

See Configuring Fluorescent Data (F-Panel for YMC FK Ribbon) using the Workbench procedure in the Fargo Workbench Printer Utility section.

- **Dual Pass option:** This refers to the fact that the fluorescing dye can be applied to a separate panel of HDP Film. (**Note:** First, the YMC ink is applied to a panel of HDP Film; then, the F and possibly K are applied to a separate panel. If this is not done, the fluorescent ink tends to mix with the YMC colors and lose its fluorescent qualities; it also tends to become visible.)

It is recommended that the user use the default “Dual Pass” option if the fluorescent image is used in places where other dye is used or if the “Invert F panel” option is selected.

- **Invert F-Panel option:** This refers to the ability to cause light or white areas of the image to fluoresce and dark colors to remain dark on the printed card when exposed to a UV light. (**Note:** This was requested because the fluorescent dye color is bright when black light is applied to it. By default, the dark areas of the image will fluoresce on the card and the lighter or white areas will have no dye applied.)

The User can select the **Invert F-Panel** option to cause the black in the design to show as dark on the card. This option is recommended if the user is printing a photo.

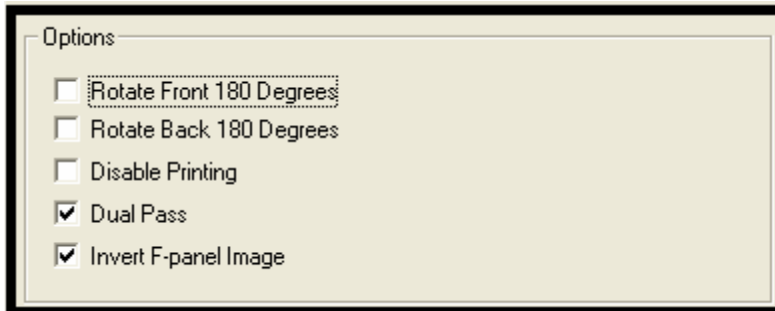

Using the Image Color tab

Use this tab to adjust color properties. (**Note:** The HDP5000 Printing Preferences window has the same Image Color tab functionality as the HDP5000-LC Printing Preferences window.)

Step	Procedure
1	Select the System Color Management color matching option to control the Sharpness, Contrast and Gamma of the printed image, as well as the individual color balance of Yellow, Magenta and Cyan . See both displays in this section. Proceed to related procedures (provided below).

Display A – Image Color tab

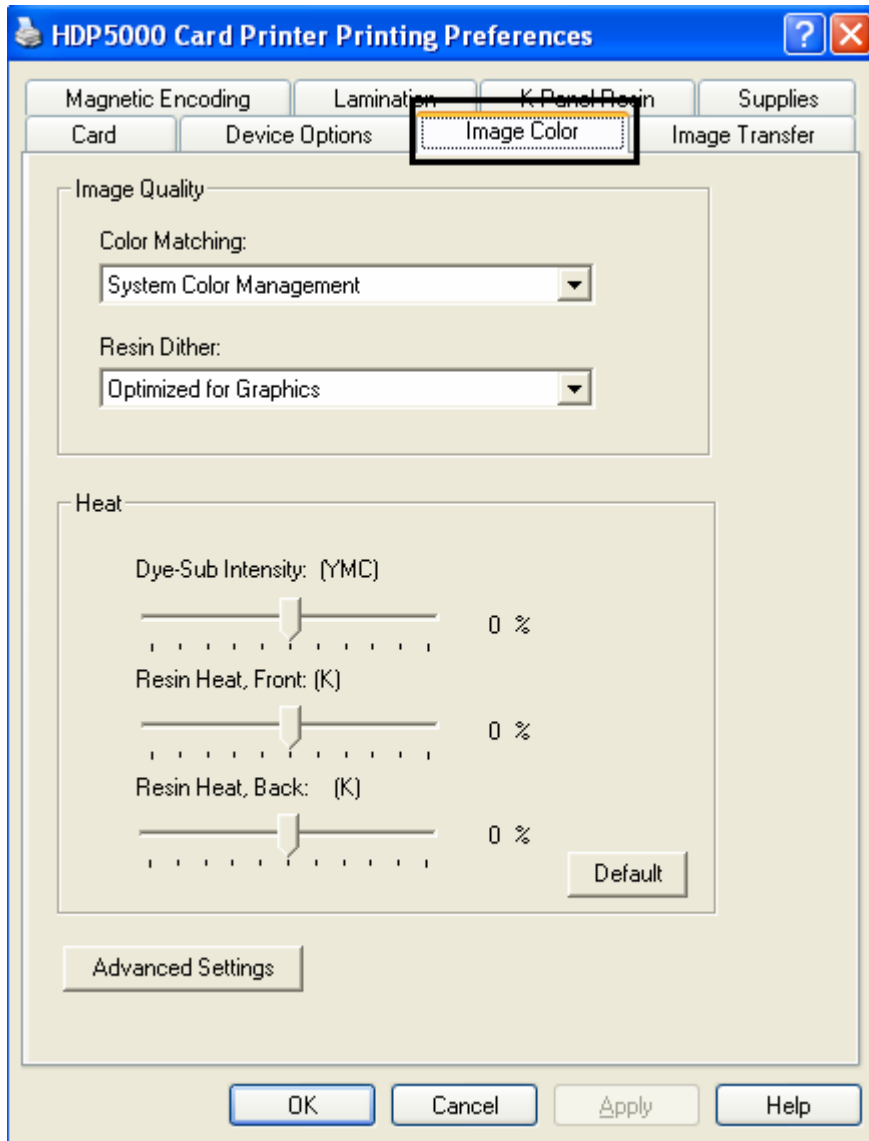

Using the Image Quality – Color Matching dropdown

Step	Procedure
1	<p>Select None (a) if interested in print speed rather than print color, (b) if color correcting the image for printing has already been done or (c) if using third party color matching software.</p> <p>OR</p> <p>Select System Color Management to allow the Printer Driver to make color corrections similar to the Algebraic option but through a more complex color matching algorithm. (Note: This option shifts colors more radically so the colors in the image will more closely match how they appear on screen.)</p>

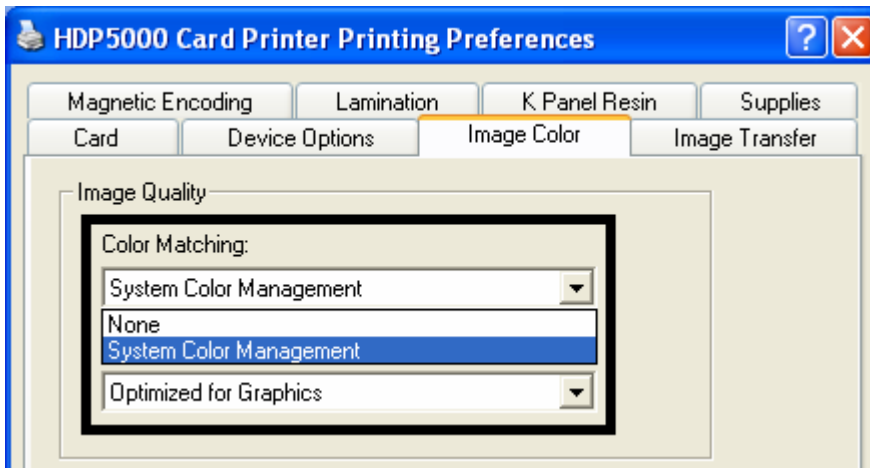

Using the Image Quality – Color Matching dropdown

Step	Procedure
2	<p>Control the overall darkness and lightness of the dye-sub printed image by adjusting the Dye-Sub Intensity slide by clicking and dragging the slide's box.</p> <ul style="list-style-type: none"> • Move the slide to the left to cause less heat to be used in the printing process, thus generating a lighter print. <p style="text-align: center;">OR</p> <ul style="list-style-type: none"> • Move the slide to the right to cause more heat to be used, thus generating a darker print. <p>(Note: This slide only affects those images printed with dye-sublimation Ribbon Panels (YMC).)</p>

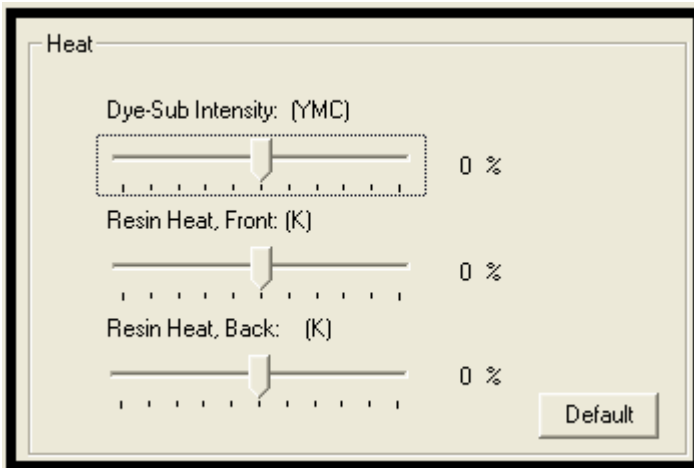

Using the Image Quality – Color Matching dropdown

Step	Procedure
3	<p>Control the amount of heat the Printer uses when printing with the resin black Panel by adjusting the Resin Heat slide.</p> <ul style="list-style-type: none"> • Move the slide to the left to cause less heat to be used in the printing process, causing resin images to be lighter or less saturated. <p>OR</p> <ul style="list-style-type: none"> • Move the slide to the right to cause more heat to be used, causing resin images to be darker or more saturated. <p>(Note: This control can be helpful for fine-tuning the sharpness of resin text and bar codes.)</p>

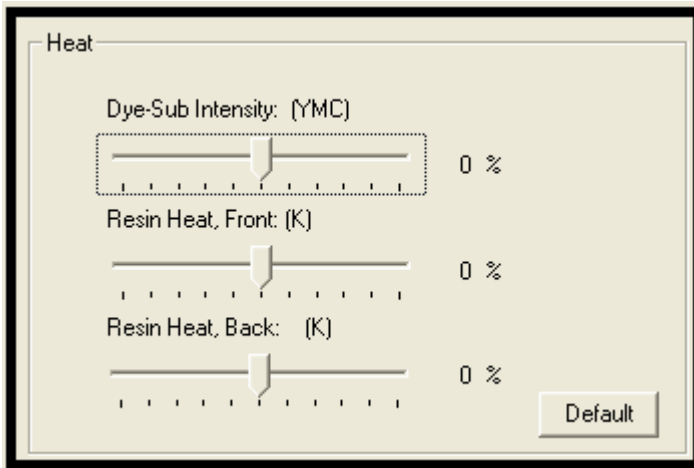

Using the Image Quality – Color Matching dropdown

Step	Procedure
4	As needed, return all options to their factory settings by clicking on the Default button.

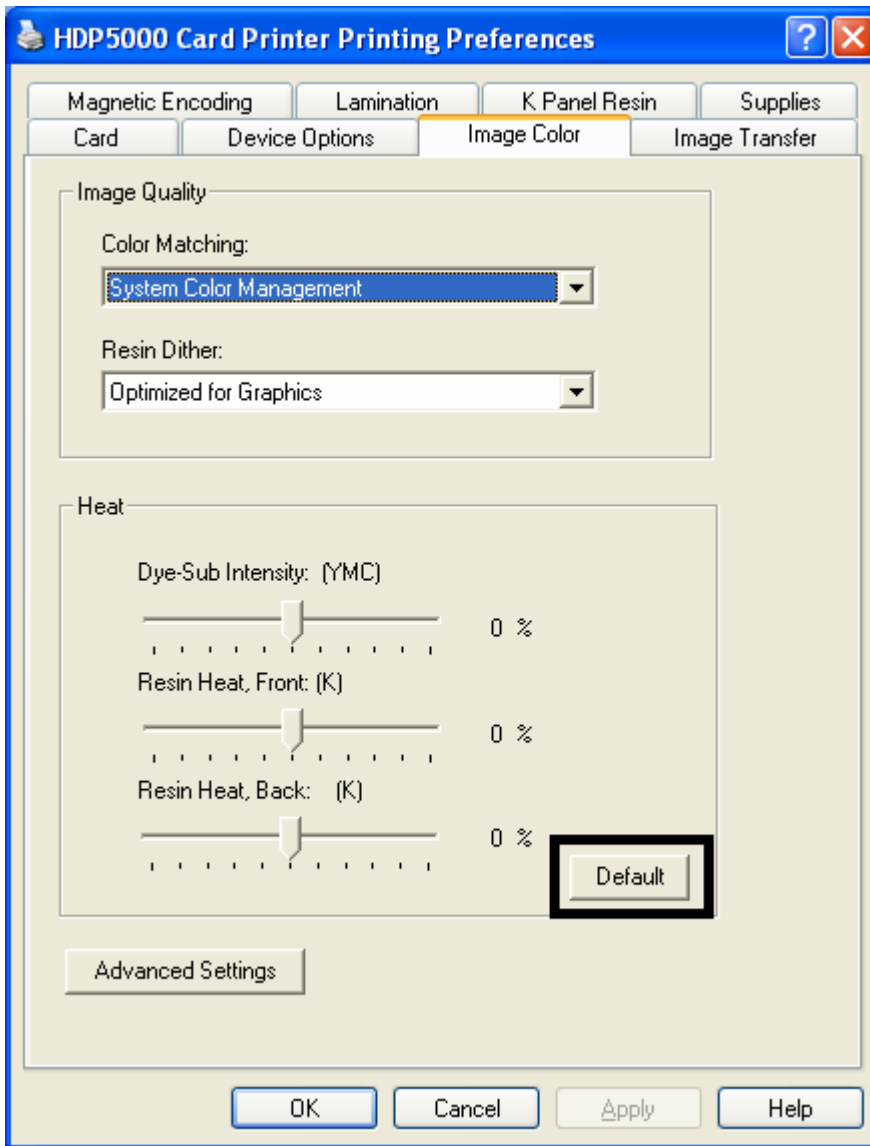

Adjusting for the Resin Dither

Select the appropriate dither method according to the type of image to be printed. (**Note:** This option only affects those objects printed on the backside of a card with the resin black Panel of a YMCK YMCKK and YMCKI Print Ribbon. This is only enabled when using at least one K panel and dual sided enabled, splitting one set of panels.)

Step	Procedure
1	Select Optimized for Graphics when printing lower quality images (e.g., clipart, logos, etc.) with resin. OR Select Optimized for Photo when printing photo quality images with resin.

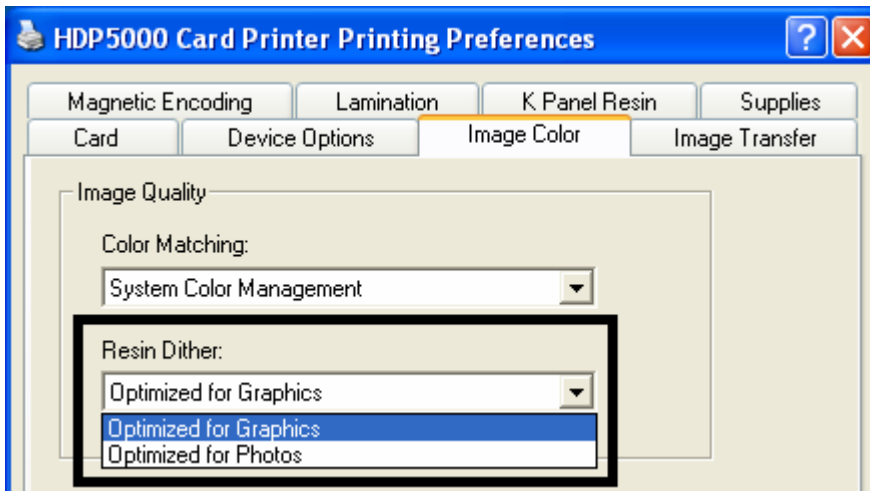

Using the Advanced Image Color window

Step	Procedure
1	Click on the Advanced Settings button to bring up the Advanced Image Color window. See below.

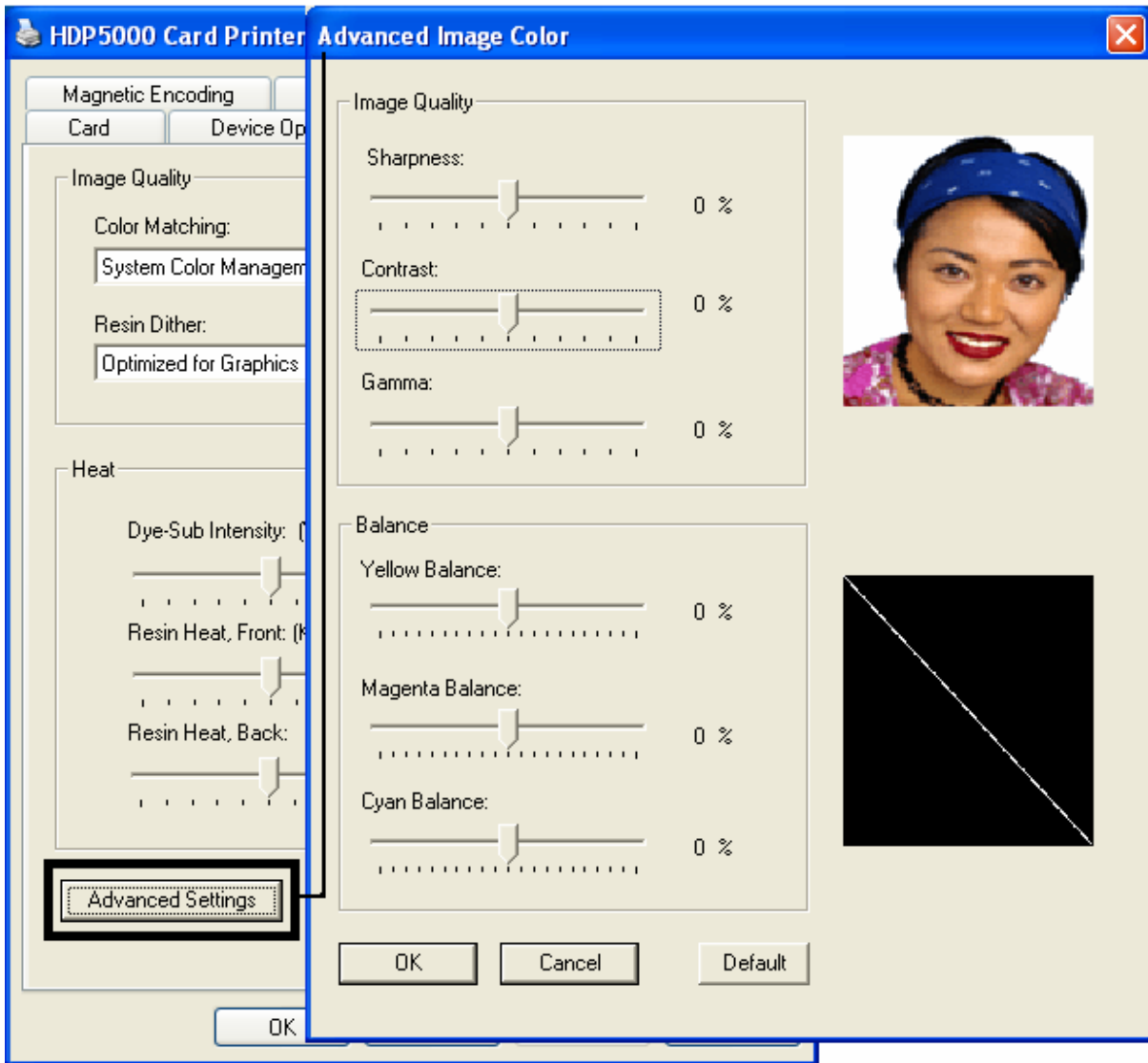

Using the Advanced Image Color window

Step	Procedure
2	<p>For the Image Quality slider bar controls, see below.</p> <ul style="list-style-type: none"> • Click OK to accept any variance from the default (for this specific slider bar) and return to the Image Color tab window. • Click Cancel to negate any variance on the slide and return to the Image Color tab window. • Click on the Default button to clear changes back to the default settings for this window only. <p>In addition, here are further instructions:</p> <ul style="list-style-type: none"> • Sharpness (Default, 0%): Move the slide to the left for (-) or less sharpness. Move the slide to the right (+) or more sharpness of the printed image. Study the image (on the right) to determine correct sharpness. • Contrast (Default, 0%): Move the slide to the left for (-) or less contrast. Move the slide to the right (+) or more contrast of the printed image. Study the image (on the right) to determine correct contrast. • Gamma (Default, 0%): Move the slide to the left for (-) or less gamma. Move the slide to the right (+) or more gamma of the printed image. Study the image (on the right) to determine correct gamma.

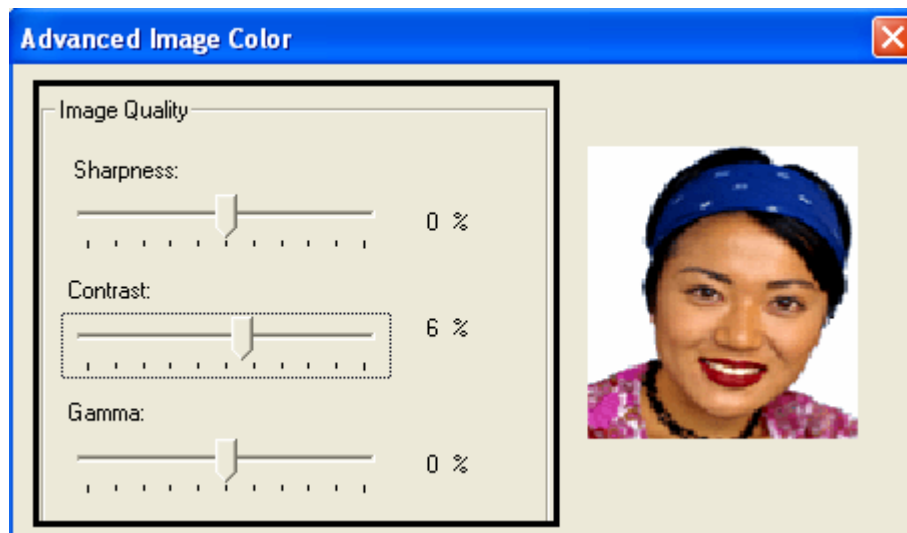

Using the Advanced Image Color window

Step	Procedure
3	<p>For the Balance slider bar controls, see below.</p> <ul style="list-style-type: none"> • Click OK to accept any variance from the default (for this specific slider bar) and return to the Image Color tab window. • Click Cancel to negate any variance on the slide and return to the Image Color tab window. • Click on the Default button to clear changes back to the default settings for this window only. <p>In addition, here are further instructions:</p> <ul style="list-style-type: none"> • Yellow Balance (Default, 0%): Move the slide to the left for (-) or less yellow as an individual color. Move the slide to the right (+) or more yellow as an individual color balance. Study the image (on the right) to determine correct color yellow balance effect. • Magenta Balance (Default, 0%): Move the slide to the left for (-) or less magenta as an individual color. Move the slide to the right (+) or more magenta as an individual color balance. Study the image (on the right) to determine correct color magenta balance effect. • Cyan Balance (Default, 0%): Move the slide to the left for (-) or less cyan as an individual color balance. Move the slide to the right (+) or more cyan as an individual color balance. Study the image (on the right) to determine correct color cyan balance effect.

Using the Advanced Image Color window

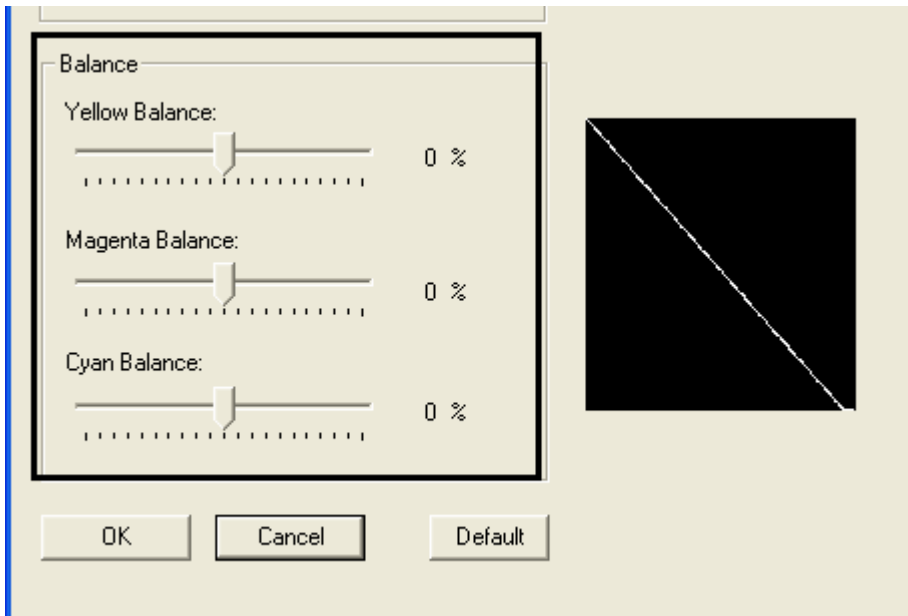

Using the Advanced Image Color window

Step	Procedure
4	Click on the Default button to clear changes back to the default settings for this window only and NOT for the Advanced Image Color dialog box

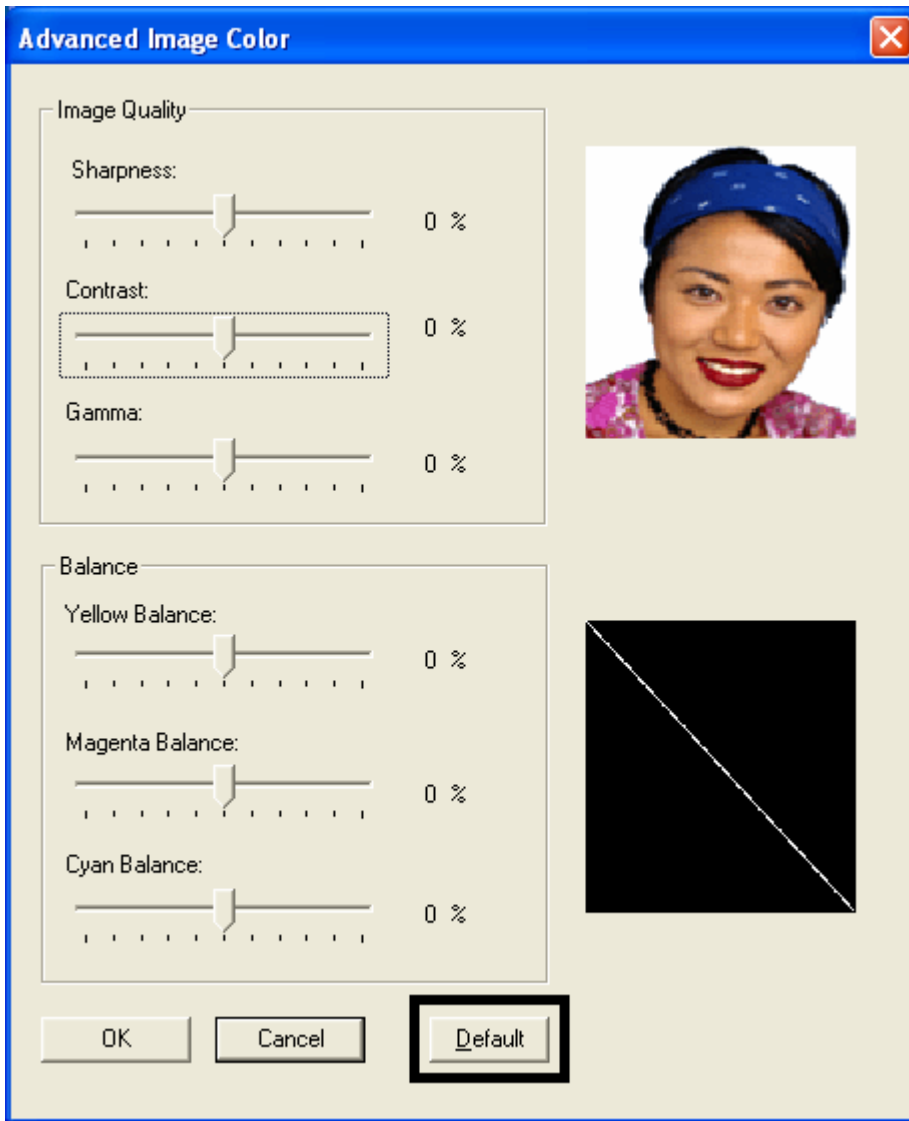

Using the Image Transfer tab

Use this tab to adjust the **Image Position**, **Transfer Dwell Time** and **Transfer Temperature**. (Note: The HDP5000 Printing Preferences window has the same Image Color tab functionality as the HDP5000-LC Printing Preferences window.)

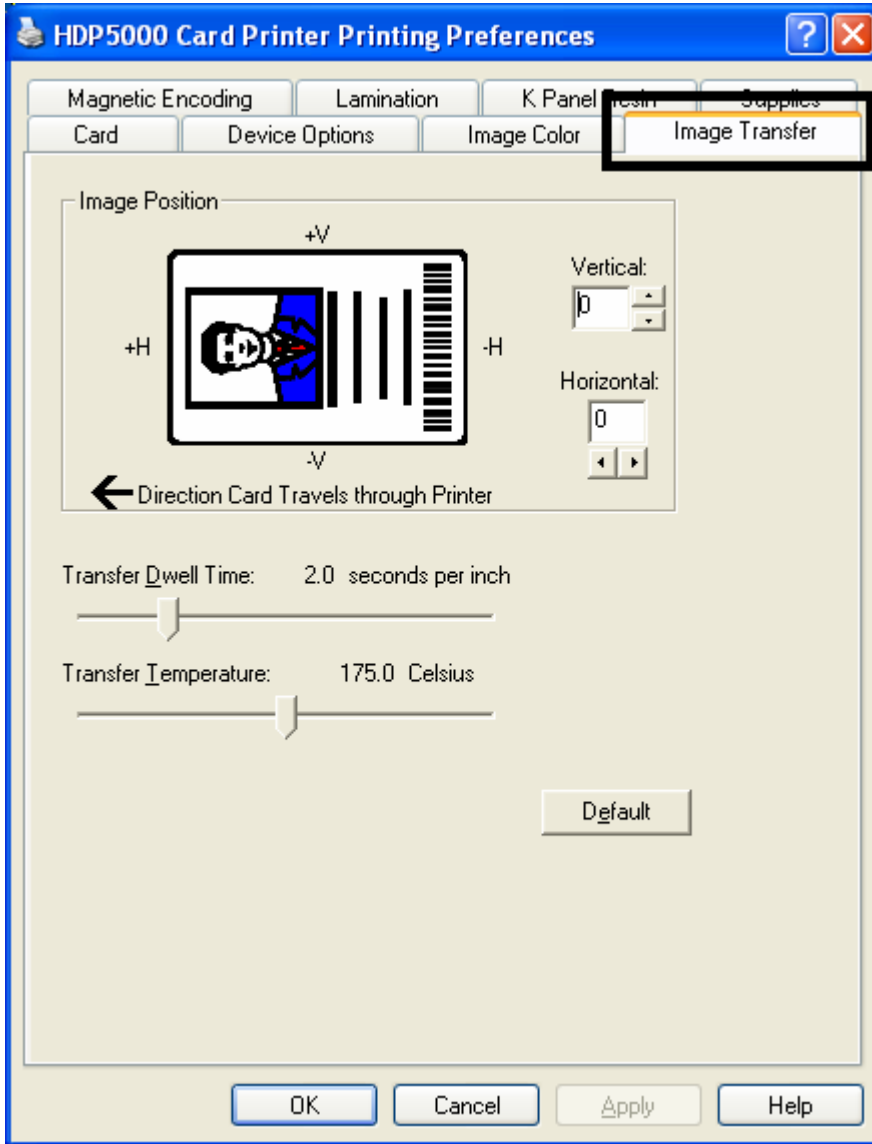

Adjusting the Image Position controls

Use the **Image Position** controls to position the image on a card (to be adjusted).

Step	Procedure
1	<p>Adjust the Image Position values by clicking on the Vertical and Horizontal adjustment arrows.</p> <ul style="list-style-type: none"> • These values ensure that the Cards always remain in the same position as they travel through the Printer (regardless of image orientation). • The Card Illustration (shown in the Image Position box) will flip and rotate according to the selection of Portrait, Landscape or Rotate 180 Degrees. • The outline around the illustration will always remain in the same Landscape orientation.

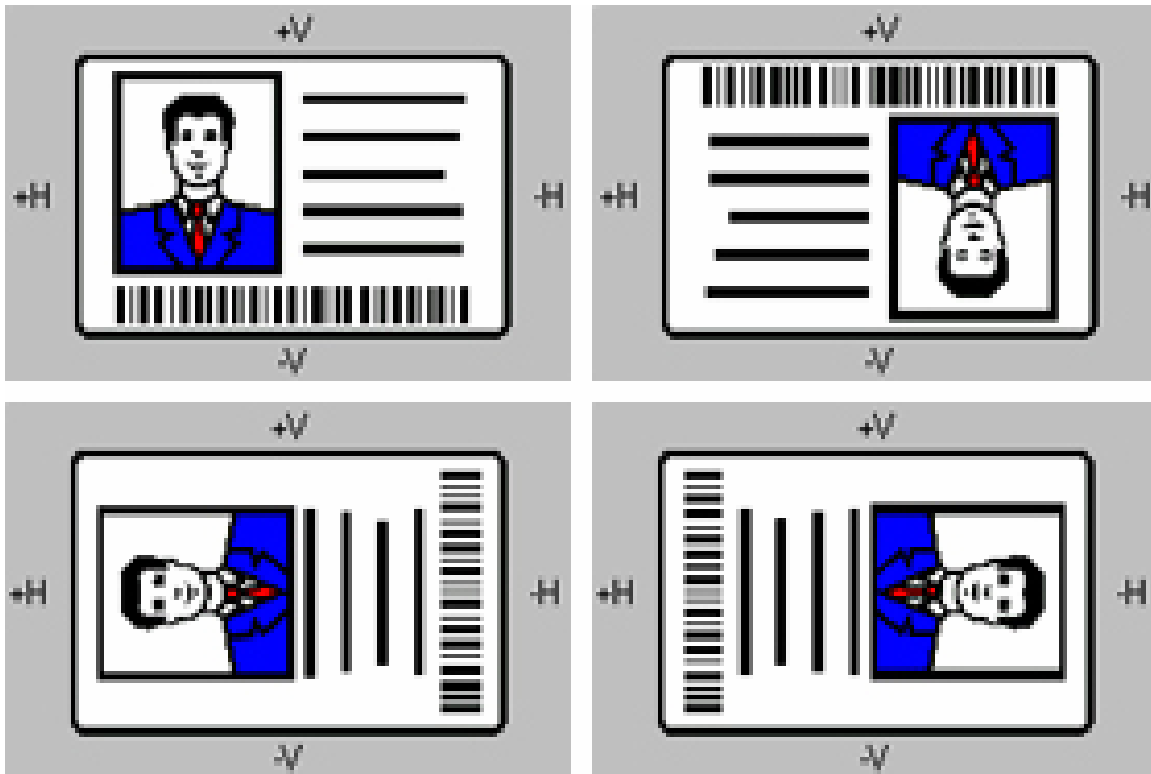

Adjusting the Image Position controls

The display (below) represents how the printed image will move in relation to the fixed card position as positive and negative image placement values are entered.

Step	Procedure
2	<p>Follow these instructions:</p> <ul style="list-style-type: none"> Use the Vertical adjustment to move the image toward the front of the Printer if a positive number is entered and toward the rear of the Printer if a negative number is entered. <p>OR</p> <ul style="list-style-type: none"> Use the Horizontal adjustment to move the image toward the card output side of the Printer if a positive number is entered and toward the card input side of the Printer if a negative number is entered. <p>(Note: The maximum value for the Vertical and Horizontal adjustments is ± 100 Pixels (10 Pixels = 0.03 (.8mm).)</p>

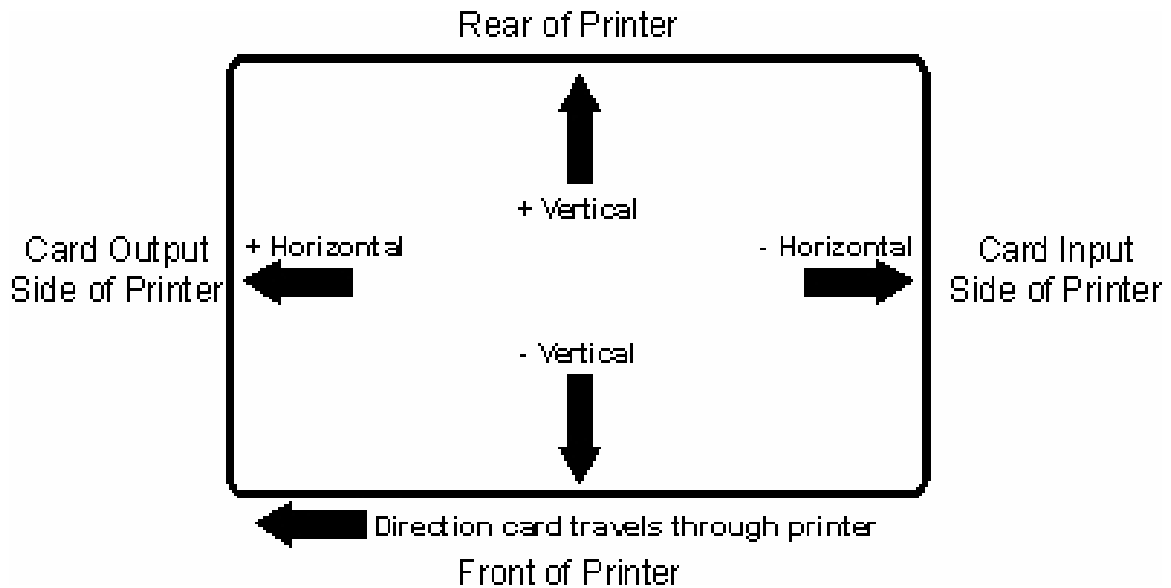

Adjusting the Transfer Dwell Time and Temperature

Use the Image Transfer option to control of the **Transfer Dwell Time** and **Transfer Temperature**.

- These settings control the speed and temperature at which printed images are transferred from the HDP Film to the card. These settings may vary depending on the card type.
- The Printer Driver automatically optimizes these settings according to the selection made in the **Card Type** option.
- Changes made to the Dwell Time and temperature settings are saved for the selected **Card Type** option (upon exiting the Printer Driver setup in the Printer's Control Panel).

Step	Procedure
1	<p>Transfer Dwell Time Sets dwell time for InTM transfer in seconds per inch Lower limit = 1.0 seconds per inch, Upper limit = 3.0 seconds per inch</p> <ul style="list-style-type: none"> • UltraCard III - Composite: Default = 2.0 seconds per inch • UltraCard - PVC: Default = 2.0 seconds per inch • Custom: Default = 2.0 seconds per inch
2	<p>Transfer Temperature Sets temperature for InTM transfer in Celsius Lower limit = 150.0 Celsius, Upper limit = 190.0 Celsius</p> <ul style="list-style-type: none"> • UltraCard III - Composite: Default = 175.0 seconds per inch • UltraCard- PVC: Default = 175.0 Celsius • Custom: Default = 175.0 Celsius

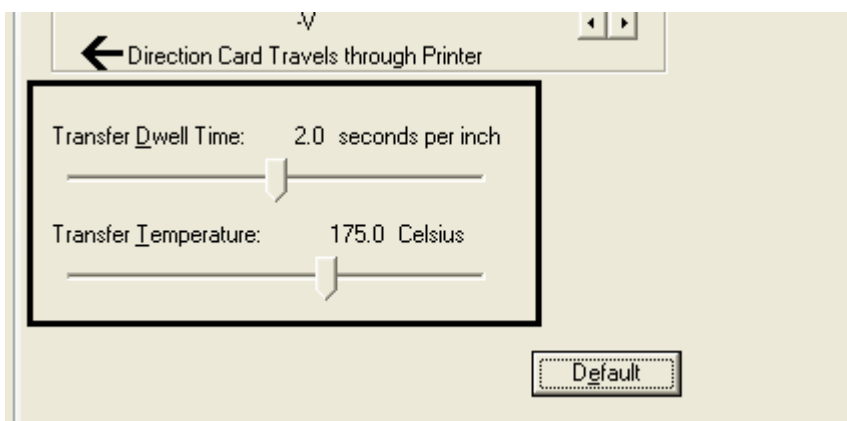

Adjusting the Transfer Dwell Time and Temperature

Step	Procedure
3	Return to the factory default settings for the selected Card Type by clicking on the Default button. If using cards (that differ from the Card Type Glossy-PVC or Matte-PVC options), select one of the Card Type Custom options.
4	<p>Adjust the dwell time and temperature settings to ensure proper image transfer. Determine the appropriate settings for the card stock by setting the Transfer Dwell Time and Transfer Temperature to the default settings. Print a card.</p> <p>a. If the HDP Film is not transferring properly, adjust these settings accordingly.</p> <p>OR</p> <p>b. If the Film is transferring properly, perform a final durability test called the Tape Test.</p> <p>For instructions on how to do a tape test, see Conducting the Tape adhesion Test procedure.</p>

Using the Default button

Step	Procedure
1	Use the Default button to reset the Transfer Dwell Time and Transfer Temperature to defaults for current Card Type choice. See below.

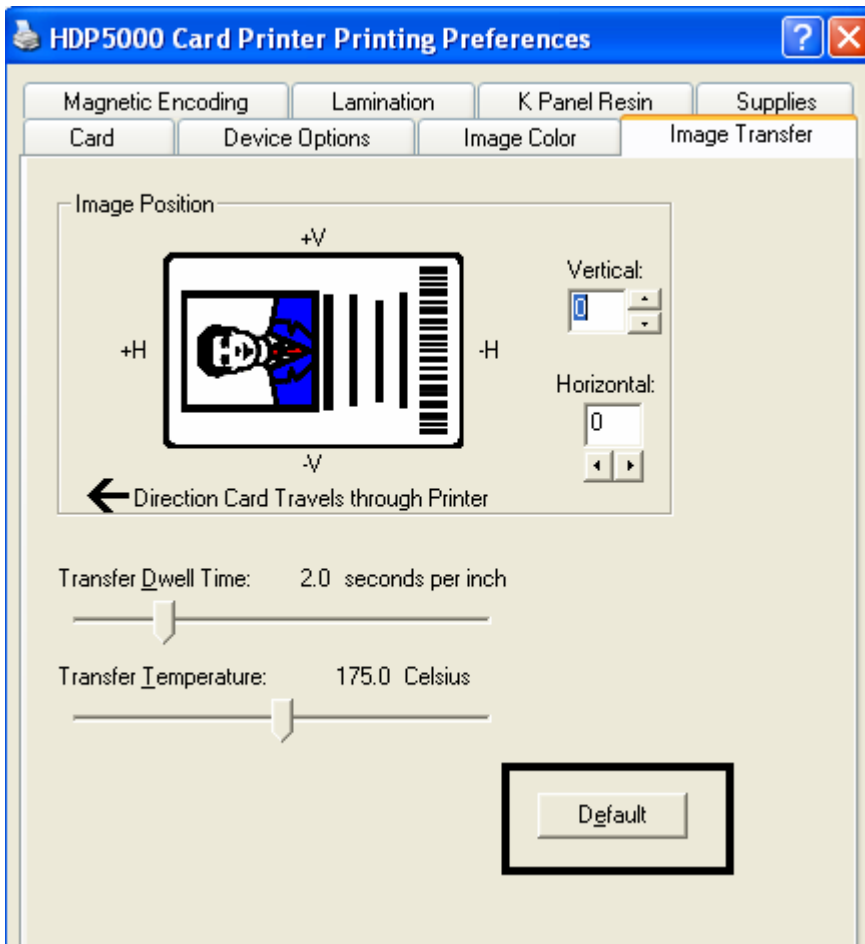

Using the Magnetic Encoding tab

Use these options only if the Printer has an optional Stripe Encoding Module installed. (Note: If no Encoder is detected, the tab is active but all functions are grayed out.)

Step	Procedure
1	Select the Magnetic Encoding tab to display options for controlling the Magnetic Stripe encoding process. (Note: The following describes these options and the Printer's magnetic encoding process.)

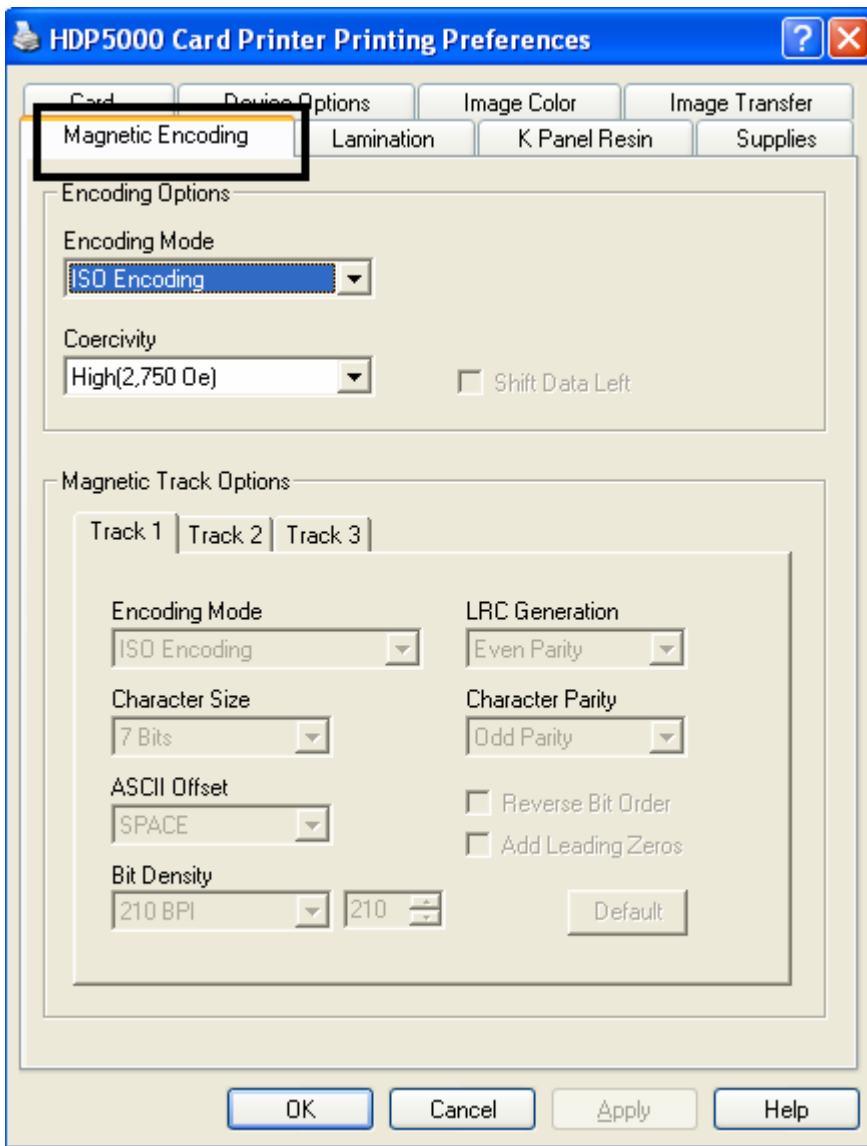

Using the Encoding Mode dropdown list

Use the Encoding Mode option to specify which magnetic encoding standard to use.

Category	Description
Installation	The HDP Card Printer can be installed with one of two types of factory-installed Magnetic Stripe Encoding Modules.
Magnetic Encoding options (changing and modifying)	Change the encoding mode and coercivity setting or modify the ISO standards for tracks 1, 2 and 3, by correctly modifying these Magnetic Encoding options.
ISO Encoding selection (active and inactive functions)	If you select ISO Encoding , you send down a formatted set of characters. (Note: This selection activates the track tabs. However, all functions on the Track tabs are inactive/gray and display ISO defaults, which are the defaults listed for each track below. The Shift Data Left check box remains unchecked and inactive.)

Using the Encoding Mode dropdown list

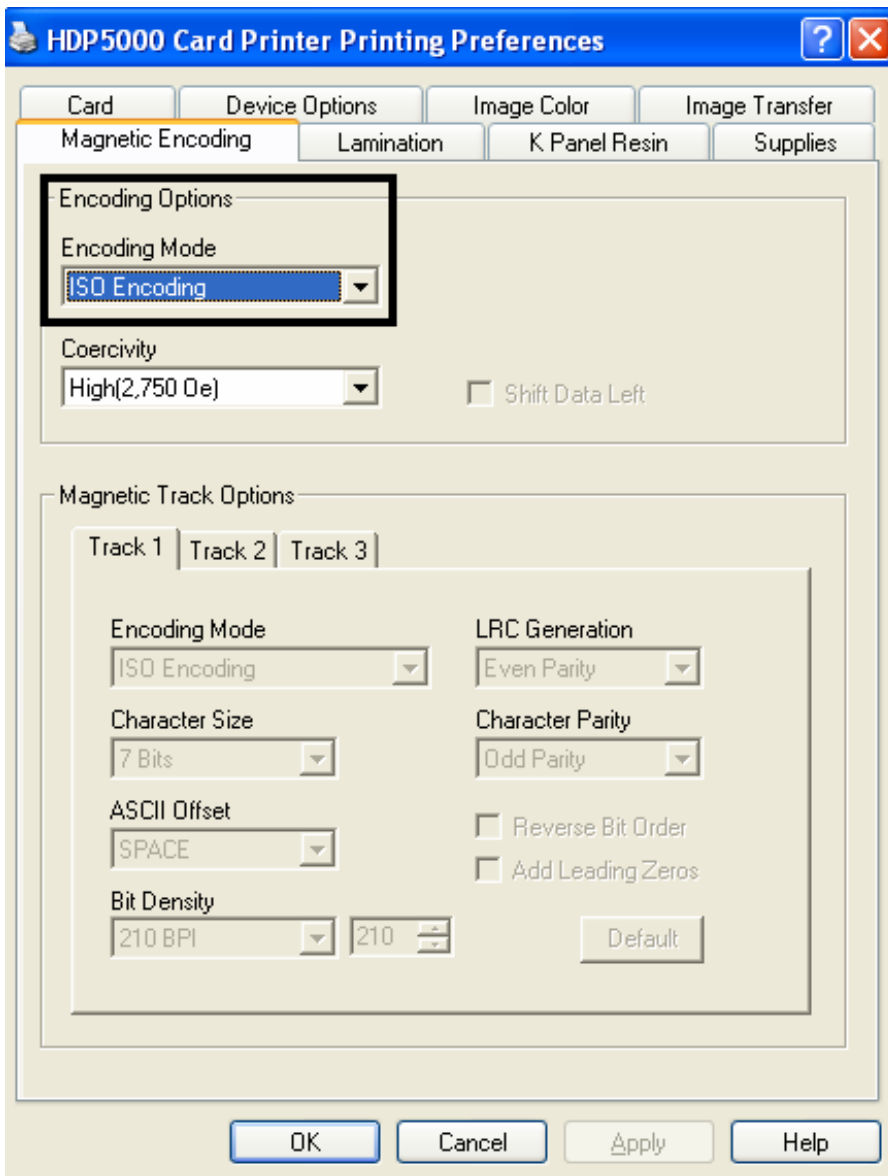

Using the Encoding Mode dropdown list

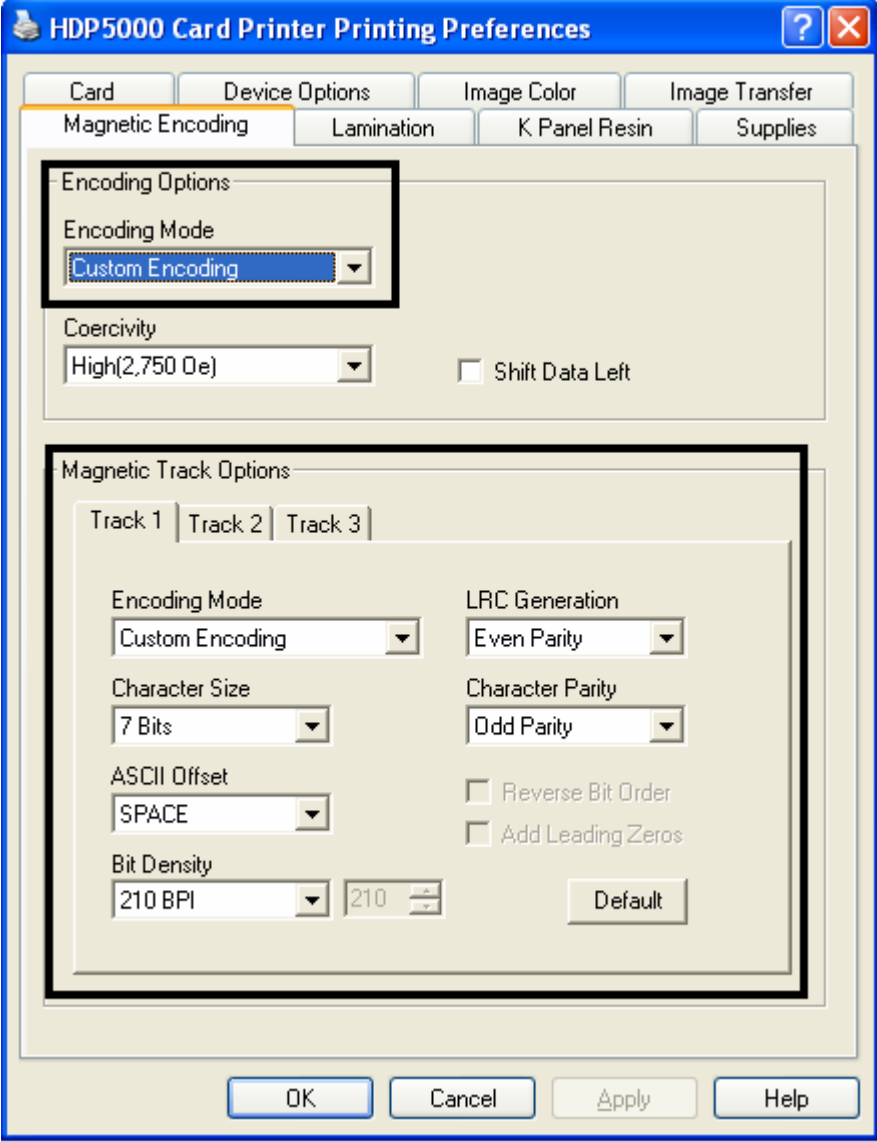
Category	Description
<p>Custom Encoding selection (active and inactive functions)</p>	<p>If you select Custom Encoding, all options are active. The Default is ISO Encoding. (Note: The defaults are the same as the ISO Encoding defaults. However, all functions on the Magnetic Track Options tabs are active.)</p>  <p>The screenshot shows the 'HDP5000 Card Printer Printing Preferences' dialog box. The 'Device Options' tab is selected, and the 'Magnetic Encoding' sub-tab is active. In the 'Encoding Options' section, the 'Encoding Mode' dropdown is set to 'Custom Encoding'. Below it, the 'Coercivity' is set to 'High(2,750 Oe)' and the 'Shift Data Left' checkbox is unchecked. The 'Magnetic Track Options' section is also visible, with 'Track 1' selected. Under 'Track 1', the 'Encoding Mode' is 'Custom Encoding', 'LRC Generation' is 'Even Parity', 'Character Size' is '7 Bits', 'Character Parity' is 'Odd Parity', 'ASCII Offset' is 'SPACE', 'Bit Density' is '210 BPI', and 'Reverse Bit Order' and 'Add Leading Zeros' are unchecked. A 'Default' button is present at the bottom right of the 'Magnetic Track Options' section. The dialog box has 'OK', 'Cancel', 'Apply', and 'Help' buttons at the bottom.</p>

Using the Encoding Mode dropdown list

Category	Description
<p>Raw Binary Encoding selection (active and inactive functions)</p>	<p>If you select Raw Binary Encoding, you send down a raw binary string rather than a formatted set of characters. (Note: The Coercivity dropdown function is active and the Bit Density, Character Size, Reverse Bit Order and Add Leading Zeros are also active and configurable for each track when Raw Binary Encoding is selected).</p> <p>Reverse Bit Order is used to reverse the character bits and is used for the encryption of data in specific programs</p> <p>Add Leading Zeros is used to add a set number of leading zeros to the magnetic string in order to move the starting point of the encoded data in specific programs for encryption of data.</p> <p>Raw Magnetic Encoding</p> <p>The User can select Raw Magnetic Encoding from the Driver.</p> <p>Raw Coercivity</p> <p>The User can select options for either High or Low Coercivity from the Driver.</p> <p>Raw Bit Density</p> <p>The User can select the Configurable Bit Density option. This option supports these standard configurable bit densities:</p> <ul style="list-style-type: none"> • 75 Bits Per Inch (BPI) • 128 BPI • 210 BPI • Custom BPI <p>Raw Bit Density Per Track</p> <p>The User can select the Configurable Bit Density, Character Size, Reverse Bit Order and Add Leading Zero options for each individual magnetic encoding track.</p>

Using the Encoding Mode dropdown list

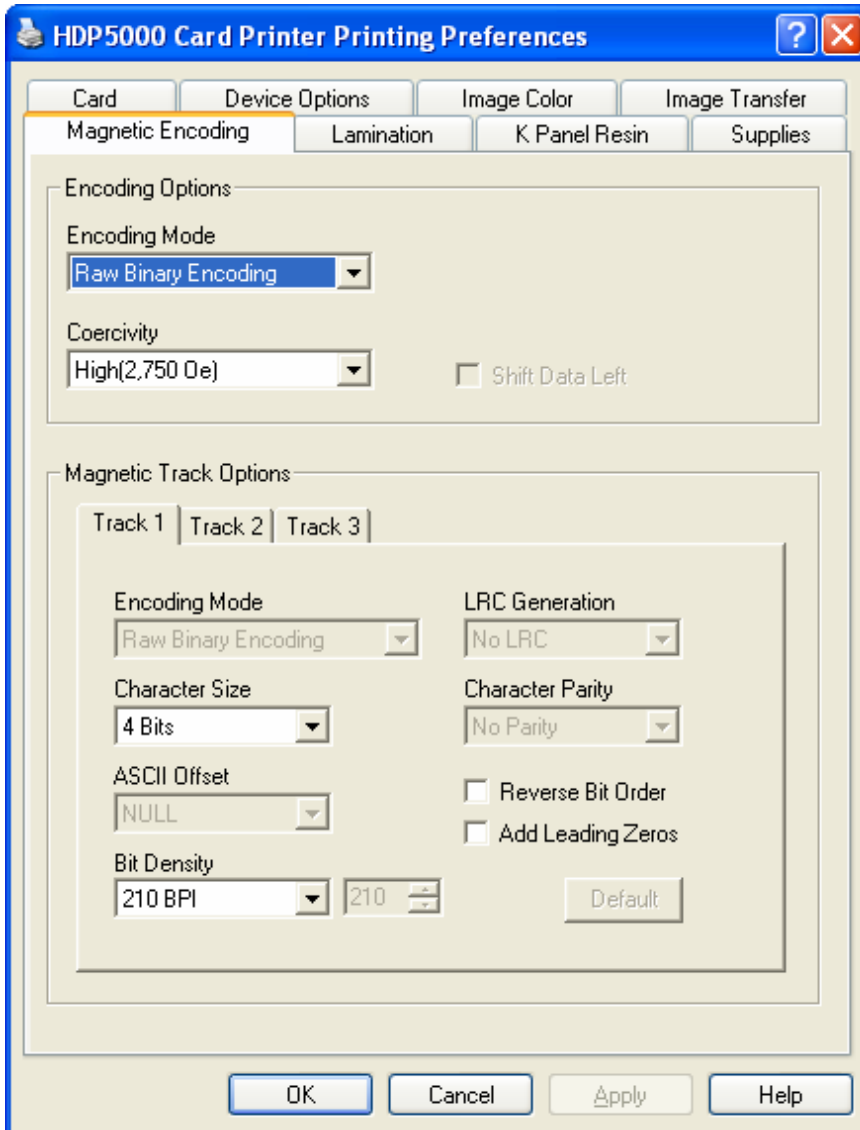

Using the Encoding Mode dropdown list

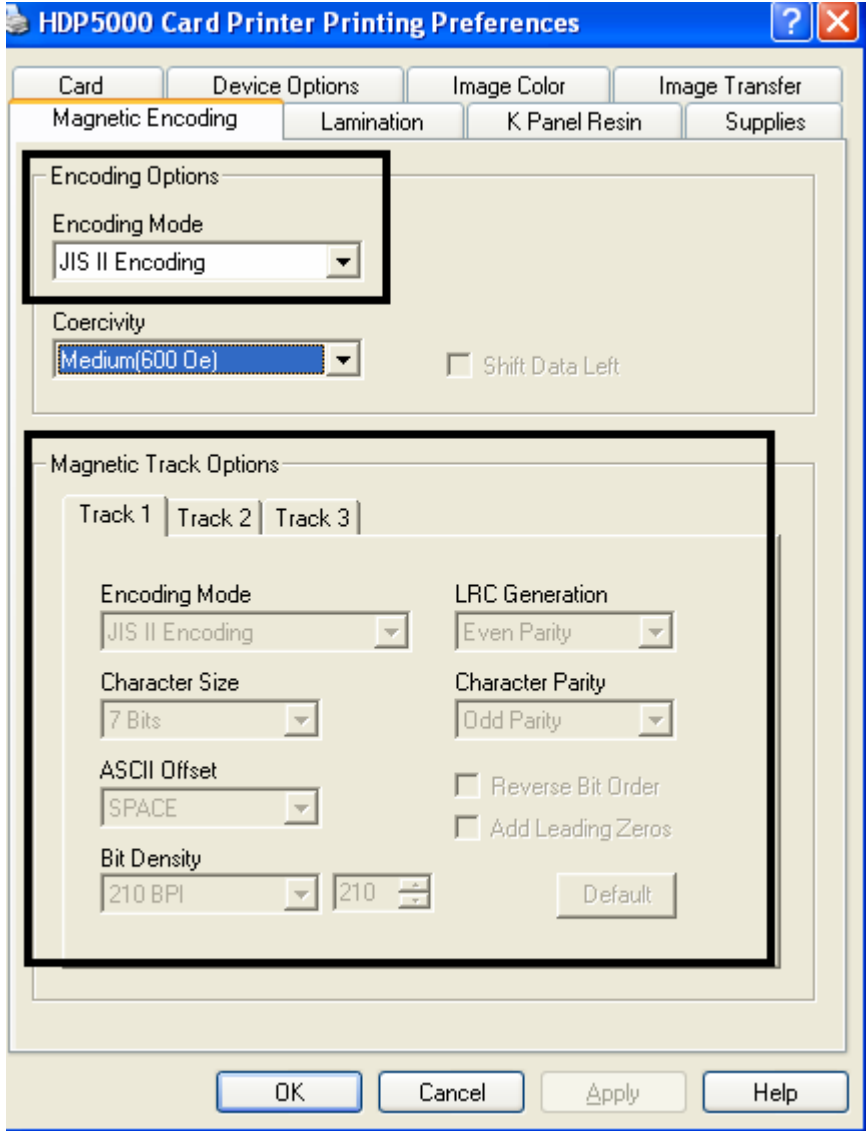
Category	Description
<p>JIS II Encoding selection (active and inactive functions)</p>	<p>If you select JIS II Encoding, specific standards are used. (Note: This selection disables all the Magnetic Track Options tabs. It also disables the Coercivity dropdown function and Shift Data Left checkbox option.)</p> <p>The default Coercivity is 600 Oe.</p>  <p>The screenshot shows the 'HDP5000 Card Printer Printing Preferences' dialog box. The 'Device Options' tab is selected. Under 'Encoding Options', the 'Encoding Mode' dropdown is set to 'JIS II Encoding'. Below it, the 'Coercivity' dropdown is set to 'Medium(600 Oe)'. The 'Shift Data Left' checkbox is unchecked. The 'Magnetic Track Options' section is disabled, indicated by a greyed-out background. The 'Magnetic Track Options' section contains settings for Track 1, Track 2, and Track 3, including 'Encoding Mode', 'LRC Generation', 'Character Size', 'Character Parity', 'ASCII Offset', 'Bit Density', 'Reverse Bit Order', and 'Add Leading Zeros'. The 'OK', 'Cancel', 'Apply', and 'Help' buttons are at the bottom.</p>

Selecting the Coercivity/Magnetic Track

Use the **ISO** option for encoding capability for either high- or low-coercivity cards on tracks 1, 2 and 3 and is the industry's standard mode of magnetic encoding.

Step	Procedure
1	<p>Select the Coercivity option (Oersted) to use the Magnetic Stripe type that matches the card type.</p> <ul style="list-style-type: none"> • High Coercivity to Super Coercivity = 2750-4000 Oersted (Fargo's High Coercivity UltraCard IIIs are 2750 Oe) • Medium Coercivity = 600 Oersted • Low Coercivity = 300 Oersted
2	<p>Select the Magnetic Track Selection option to specify which track is to be configured through the Magnetic Track Options (if the application being used requires customization of the standard ISO encoding process).</p>

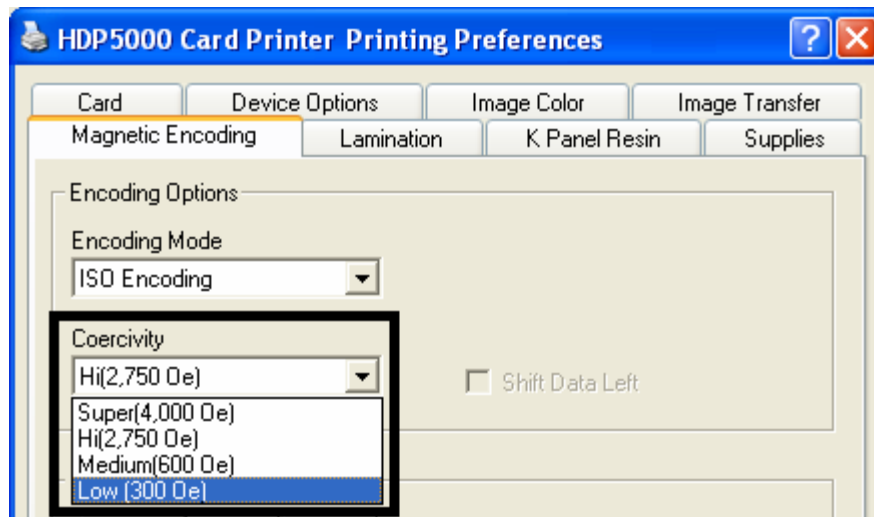

Reviewing the Shift Data Left Function

Use the **Shift Data Left** option, which applies to all tracks when selected. (**Note:** When this option is unchecked, it is the default.)

Step	Procedure
1	Select this option to shift the recorded magnetic data to the left-hand side of the card's Magnetic Stripe. (Note: This is useful in situations that require cards to be readable with insert type readers.)

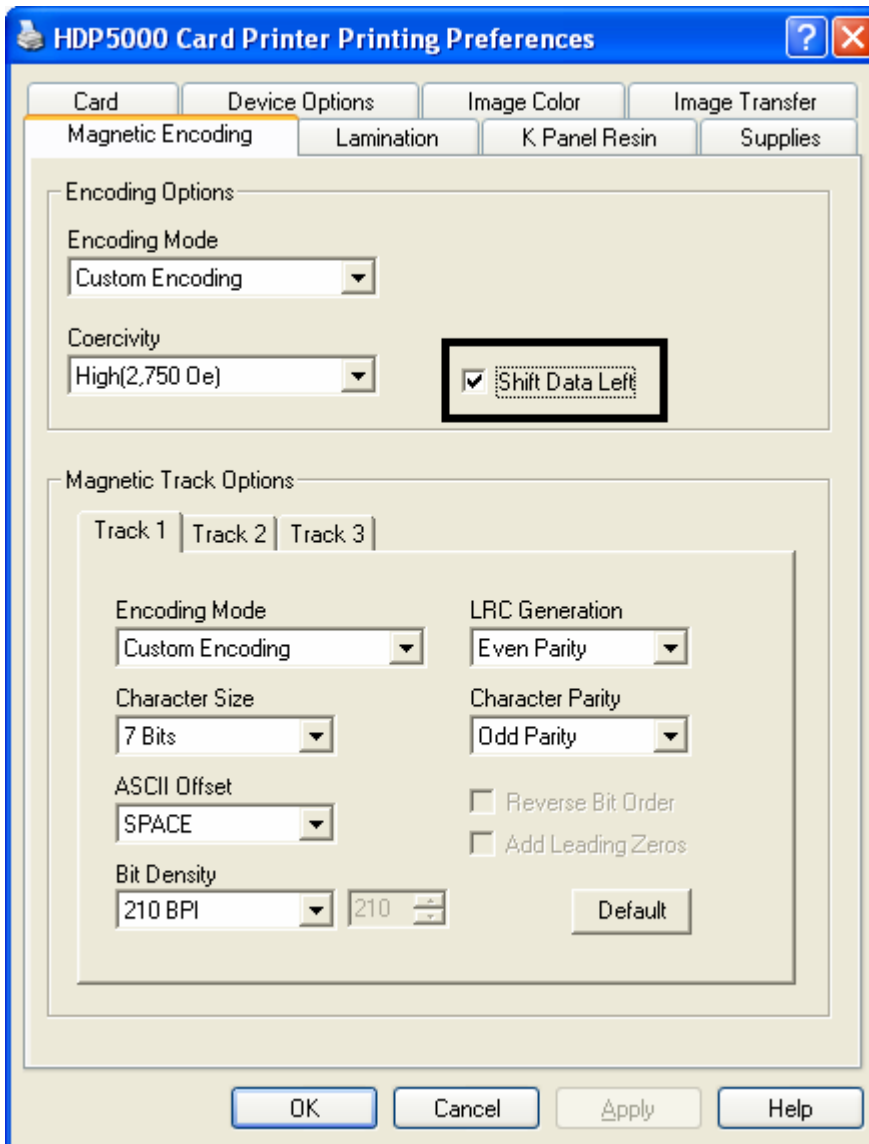

Using the Character Size buttons

Use this option to customize the Character Data Size (Bits per Character) used to encode the magnetic data on the currently selected track. (**Note:** This character size includes the parity bit (if enabled).)

Step	Procedure
1	<ul style="list-style-type: none"> Select 4 Bits to change the bits per character to 4 BPC. Select 5 Bits to change the bits per character to 5 BPC. (Note: This is the default for Tracks 2 and 3). <p style="text-align: center;">OR</p> <ul style="list-style-type: none"> Select 7 Bits to change the bits per character to 7 BPC. (Note: This is the default for Track 1). <p style="text-align: center;">OR</p> <ul style="list-style-type: none"> Select 8 Bits to change the bits per character to 8 BPC.

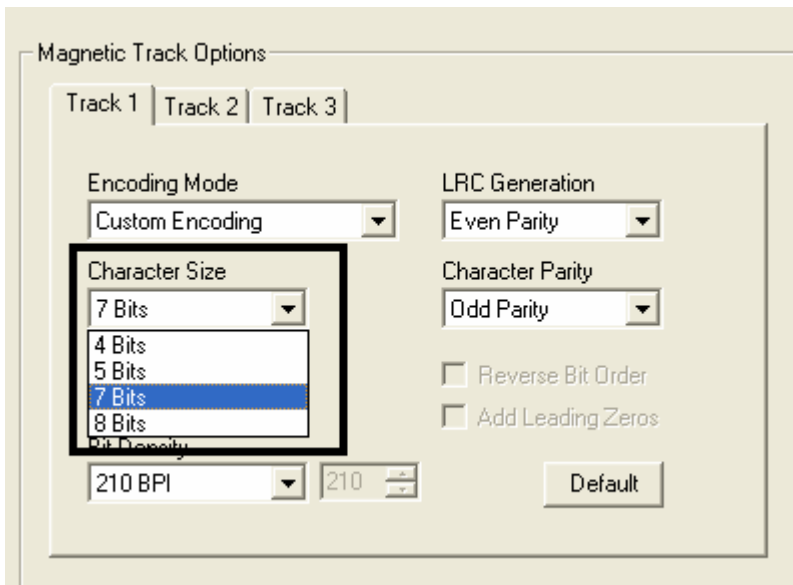

Using the ASCII Offset dropdown list

Use this option to customize the Character ASCII Offset used to encode the magnetic data on the currently selected track. (**Note:** This character-offset value is subtracted from the ASCII value of each Magnetic Stripe data character prior to encoding on the track.)

Step	Procedure
1	<ul style="list-style-type: none"> Select NULL to change the ASCII Offset to NULL. <p>OR</p> <ul style="list-style-type: none"> Select SPACE to change the ASCII Offset to SPACE. (Note: This is the default for Track 1.) <p>OR</p> <ul style="list-style-type: none"> Select ZERO to change the ASCII Offset to ZERO. (Note: This is the default for Tracks 2 and 3.)

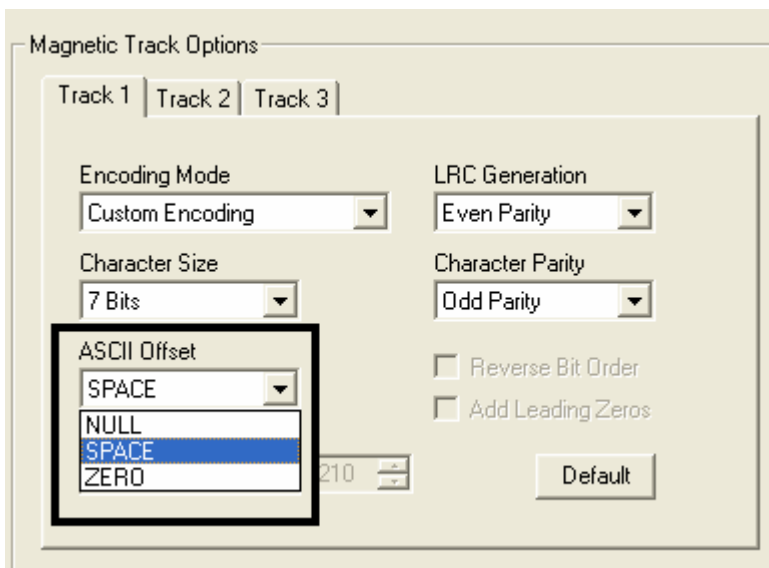

Using the Bit Density dropdown list

Use this option to customize the Bit Recording Density (Bits per Inch) used to encode the magnetic data on the currently selected track.

The default ISO Standard selections for this option are as follows:

Step	Procedure
1	<ul style="list-style-type: none"> • Select 75 BPI to change the bits per inch to 75 BPI. (Note: This is the default for Track 2.) <li style="text-align: center;">OR • Select 128 BPI to change the bits per inch to 128 BPI. <li style="text-align: center;">OR • Select 210 BPI to change the bits per inch to 210 BPI. (Note: This is the default for Tracks 1 and 3.) <li style="text-align: center;">OR • Select Custom BPI, which enables the custom BPI text box. (Note: The lower limit is 75 and upper limit is 210.)

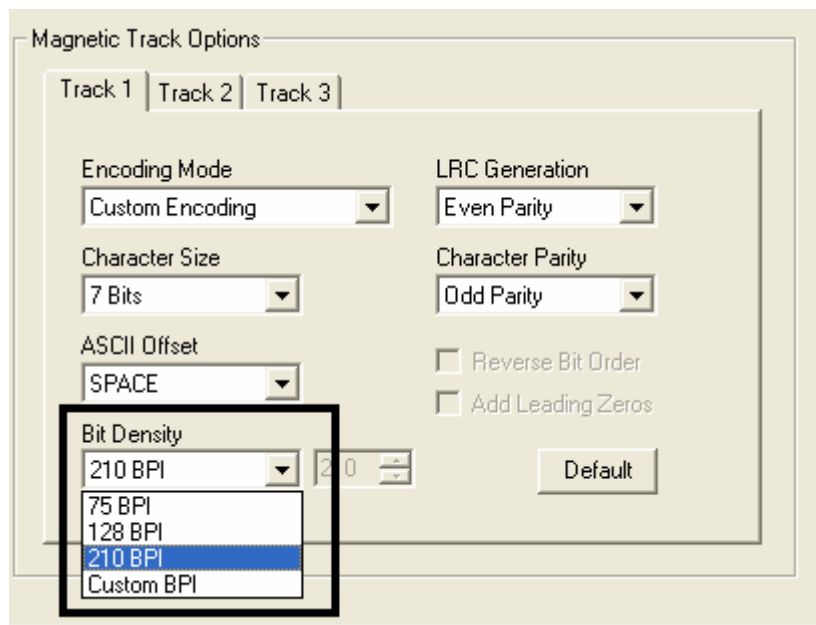

Using the LRC Generation dropdown list

Use this option to customize the LRC Generation Mode (used to encode the magnetic data on the currently selected track).

Step	Procedure
1	<ul style="list-style-type: none"> Select No LRC to change the LRC Generation to none. <p>OR</p> <ul style="list-style-type: none"> Select Even Parity to change the LRC Generation to Even Parity. (Note: This is the default for all tracks.) <p>OR</p> <ul style="list-style-type: none"> Select Odd Parity to change the LRC Generation to Odd Parity.

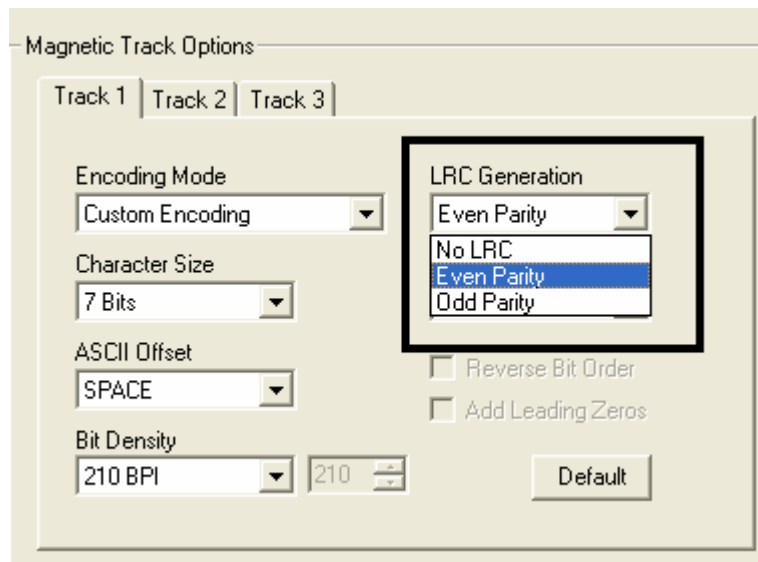

Using the Character Parity Mode dropdown list

Use this option to customize the Encoding Mode (used to encode the magnetic data on the currently selected track).

Step	Procedure
1	<ul style="list-style-type: none"> Select No Parity to change the Character Parity to none. OR Select Even Parity to change the Character Parity to Even Parity. OR Select Odd Parity to change the Character Parity to Odd Parity. (Note: This is the default for all tracks.)

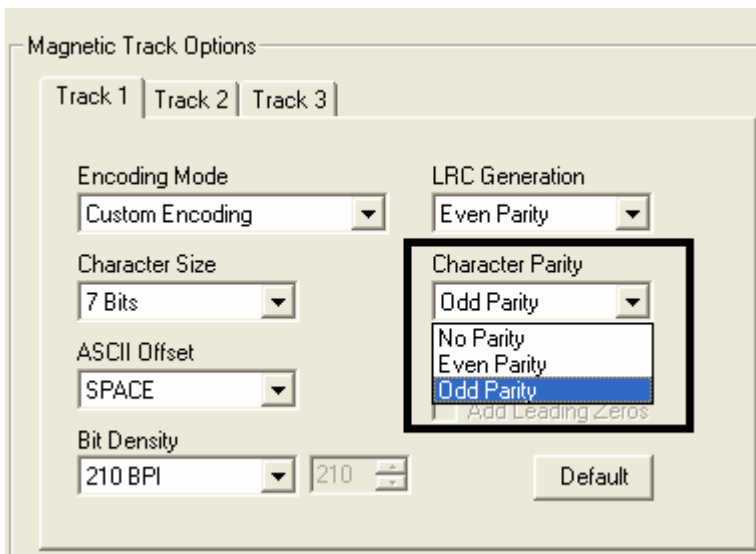

Reviewing the ISO Track Locations

The magnetic Encoding Module encodes onto tracks in accordance with an ISO 7811-2 Magnetic Stripe. For track locations, review the display below.

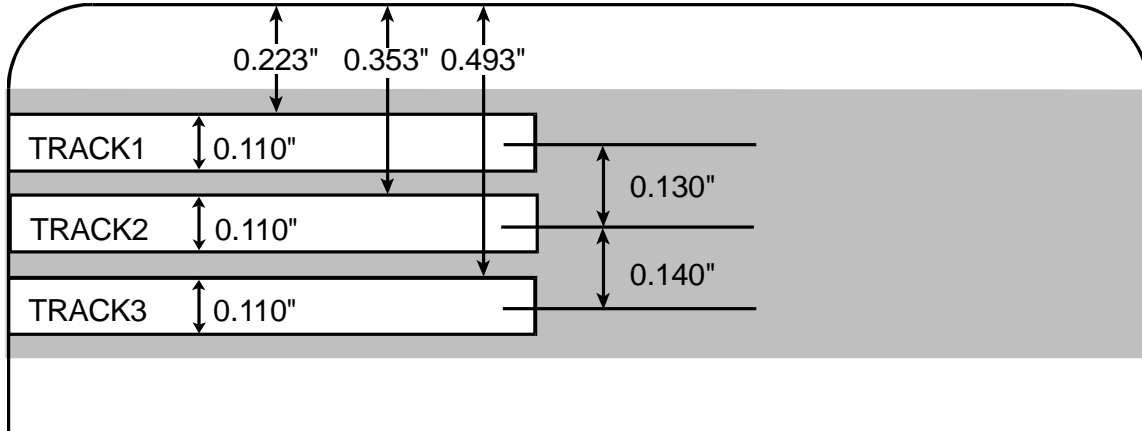

Sending the Track Information

Magnetic track data is sent in the form of text strings from the application software to the Printer Driver.

- In order for the Printer Driver to differentiate between Magnetic Track data and the rest of the printable objects, specific characters must be added to the magnetic data to be encoded.
- These specify the data that is to be encoded, the tracks to encode and mark the start and stop of the data string.
- In some cases, these specific characters are automatically added to the string of track data by ID software applications.
- In most cases, the User must carefully add these characters to the string of Magnetic Track data. If these characters are not added to the track data, the text intended for the Magnetic Track will appear as printed text on the card.
- To avoid this, track information must be entered as described below.

Step	Procedure
1	<p>When entering track data, the ~ (tilde) character is entered first, followed by the track number (1, 2 or 3) on which the data should encode. This is followed by the data to be encoded.</p> <ul style="list-style-type: none"> • The first character of this data string must be the track's specific Start Sentinel (SS) and the last character must be the specific End Sentinel (ES). • The characters or data in between the SS and ES can include all of the valid characters specific to each track. • The number of these characters, however, is limited by each track's maximum character capacity. • When segmenting track data, the appropriate Field Separator (FS) must be used. The table below shows the SS, ES, FS and the valid characters defined for each track.

Reviewing the Sample String

- Track 1: ~1%JULIEANDERSON^1234567890?
- Track 2: ~2;1234567890987654321?
- Track 3: ~3;1234567890987654321?

Track	Start Sentinel	End Sentinel	Field Separator	Valid Characters	Maximum Number of Characters
Track 1	%	?	^	ASCII 32-95 (See the table below.)	78
Track 2	;	?	=	ASCII 48-63 (See the table below.)	39
Track 3	;	?	=	ASCII 48-63 (See the table below.)	106

Reviewing the ASCII Code and Character Table

ASCII Code	Character	ASCII Code	Character	ASCII Code	Character
32	space	56	8	80	P
33	!	57	9	81	Q
34		58	:	82	R
35	#	59	;	83	S
36	\$	60	<	84	T
37	%	61	=	85	U
38	and	62	>	86	V
39	'	63	?	87	W
40	(64	@	88	X
41)	65	A	89	Y
42	*	66	B	90	Z
43	+	67	C	91	[
44	'	68	D	92	\
45	-	69	E	93]
46	.	70	F	94	^
47	/	71	G	95	_
48	0	72	H		
49	1	73	I		
50	2	74	J		
51	3	75	K		
52	4	76	L		
53	5	77	M		
54	6	78	N		
55	7	79	O		

Using the Default button

Step	Procedure
1	Use the Default button to reset defaults for the current Track tab only. See below.

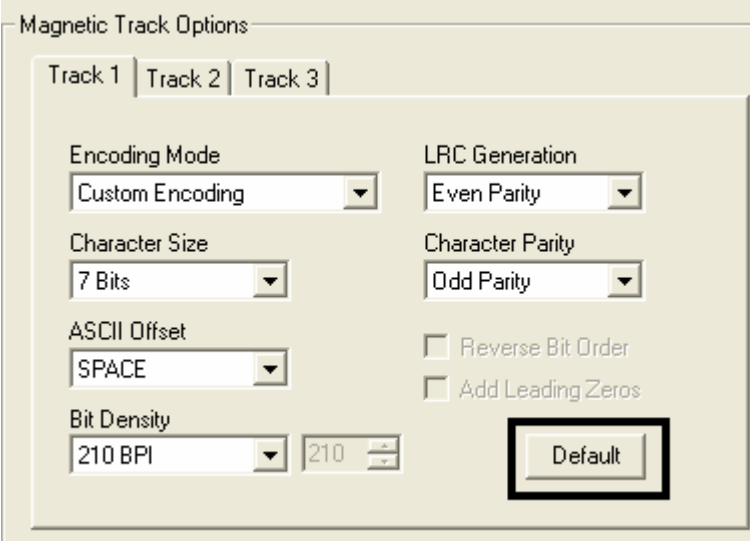

Magnetic Track Options

Track 1 | Track 2 | Track 3

Encoding Mode: Custom Encoding

LRC Generation: Even Parity

Character Size: 7 Bits

Character Parity: Odd Parity

ASCII Offset: SPACE

Reverse Bit Order

Add Leading Zeros

Bit Density: 210 BPI

210

Default

Using the Lamination tab (HDP5000-LC)

Use this option to control specific Printer functions. These options allow you to control the Printer's Lamination process. (**Note:** When no Laminator is detected, the Lamination tab is active but all functions are grayed out.)

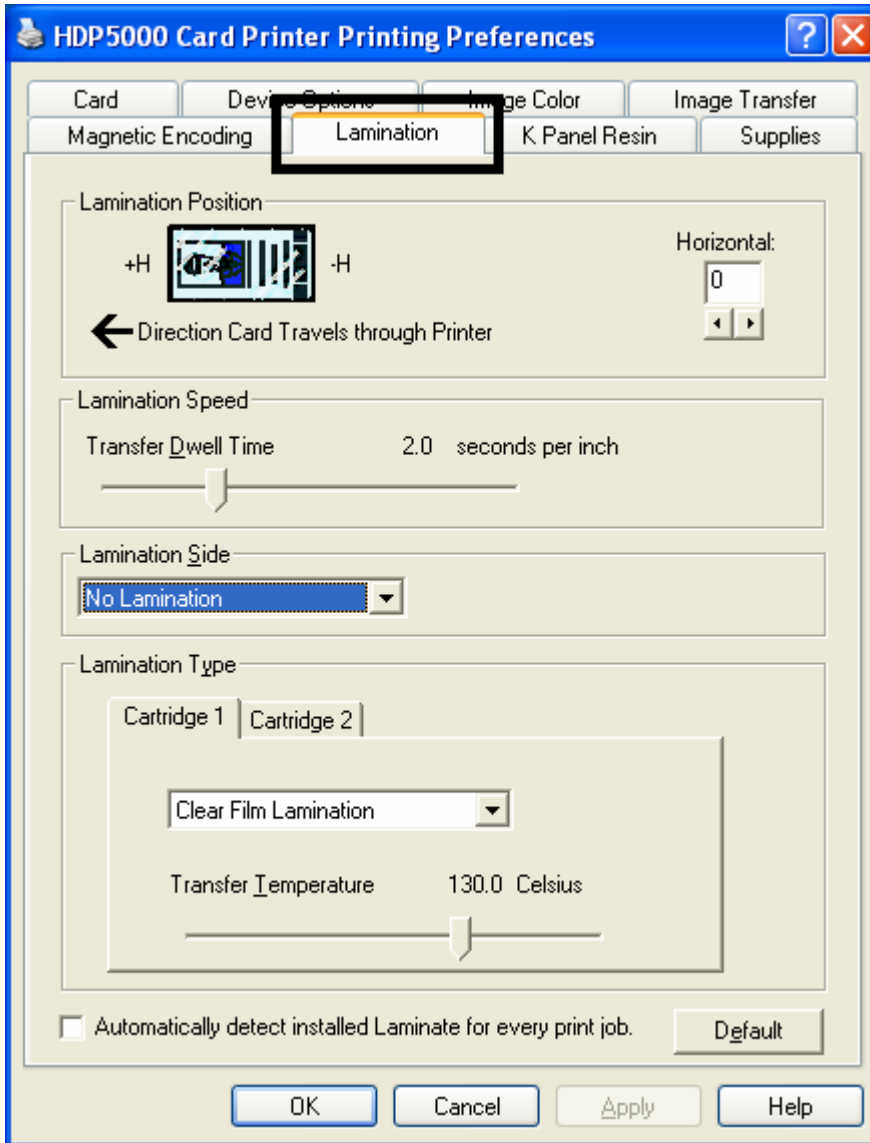

Selecting the Lamination Position

Step	Procedure
1	<p>Use the Lamination Position control to adjust the horizontal position of the PolyGuard Overlaminates. (Note: This control functions in the same manner as the Image Position controls, except only the horizontal position of the overlaminates requires adjustment.)</p> <ul style="list-style-type: none"> To adjust the Lamination position, click on the Horizontal adjustment arrows. To move the overlaminates more toward the card output side of the Printer, enter a positive number. To move the overlaminates more toward the card input side of the Printer, enter a negative number. (Note: The adjustment arrows point in the direction the patch will move on the card. The maximum value for the Horizontal adjustment is ± 100 Pixels (10 Pixels = about .03/.8mm) The default is 0.)

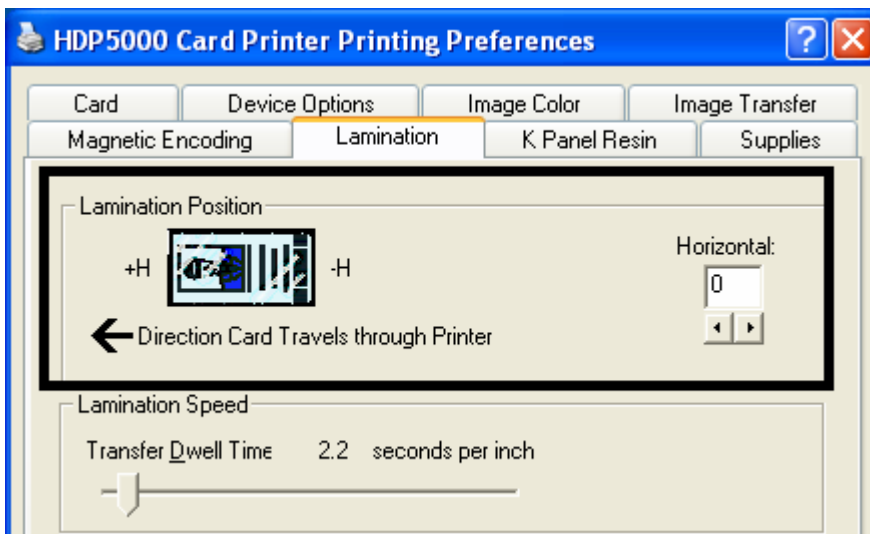

Adjusting the Lamination Speed - Transfer Dwell Time

Step	Procedure
1	<p>Adjust the Transfer Dwell Time to control the Lamination Dwell Time or through-put speed of a card in seconds per inch and the Lamination Temperature.</p> <ul style="list-style-type: none"> • Default = 2.0 seconds per inch • Upper Limit = 5.5 seconds per inch • Lower Limit = 0.8 seconds per inch

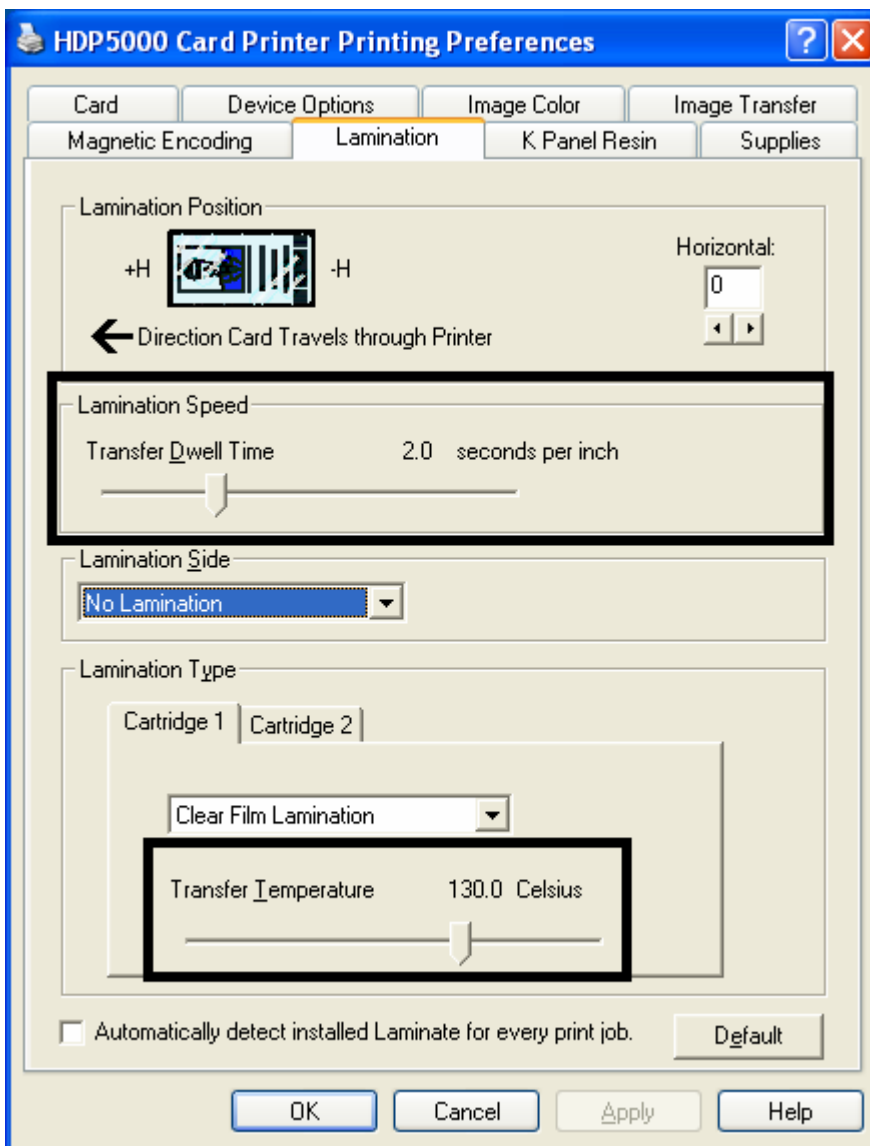

Selecting the Lamination Side dropdown menu

Step	Procedure
1	a. Select the No Lamination option if you do not want to use the Printer's built-in Laminator. b. Select Laminate Front Side , Laminate Back Side , Laminate Both Sides or Laminate Opposite Sides to specify the side(s) of the card to laminate.

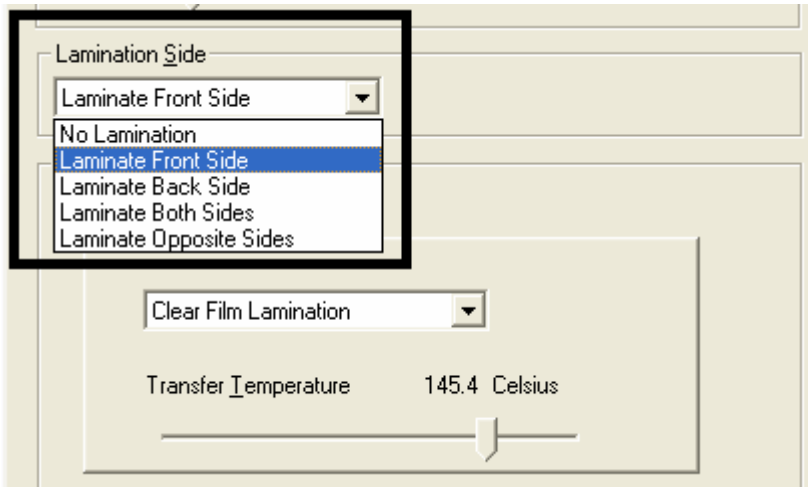

Selecting the Lamination Type

Step	Procedure
	<p>Select one of the Lamination Type options, according to which type of Lamination media is currently installed. Two types of overlaminates are supported by the Driver: Film Lamination and PolyGuard Lamination. Custom versions of each type are also available.</p> <ul style="list-style-type: none">• Select the Clear Film Lamination option if the Thermal Transfer Film Overlaminates type is installed in the Lamination Module.• Select the 0.6 PolyGuard Lamination option or 1.0 PolyGuard Lamination option for either patch thickness. (Note: These require different heat settings and Lamination speeds. Select the appropriate option according to the thickness of the PolyGuard material you are using.)• Select Registered Film Lamination if you have a registered thermal transfer film.• PolyGuard Alternating Patch and Holographic Film Lamination are options.

Selecting the Lamination Type

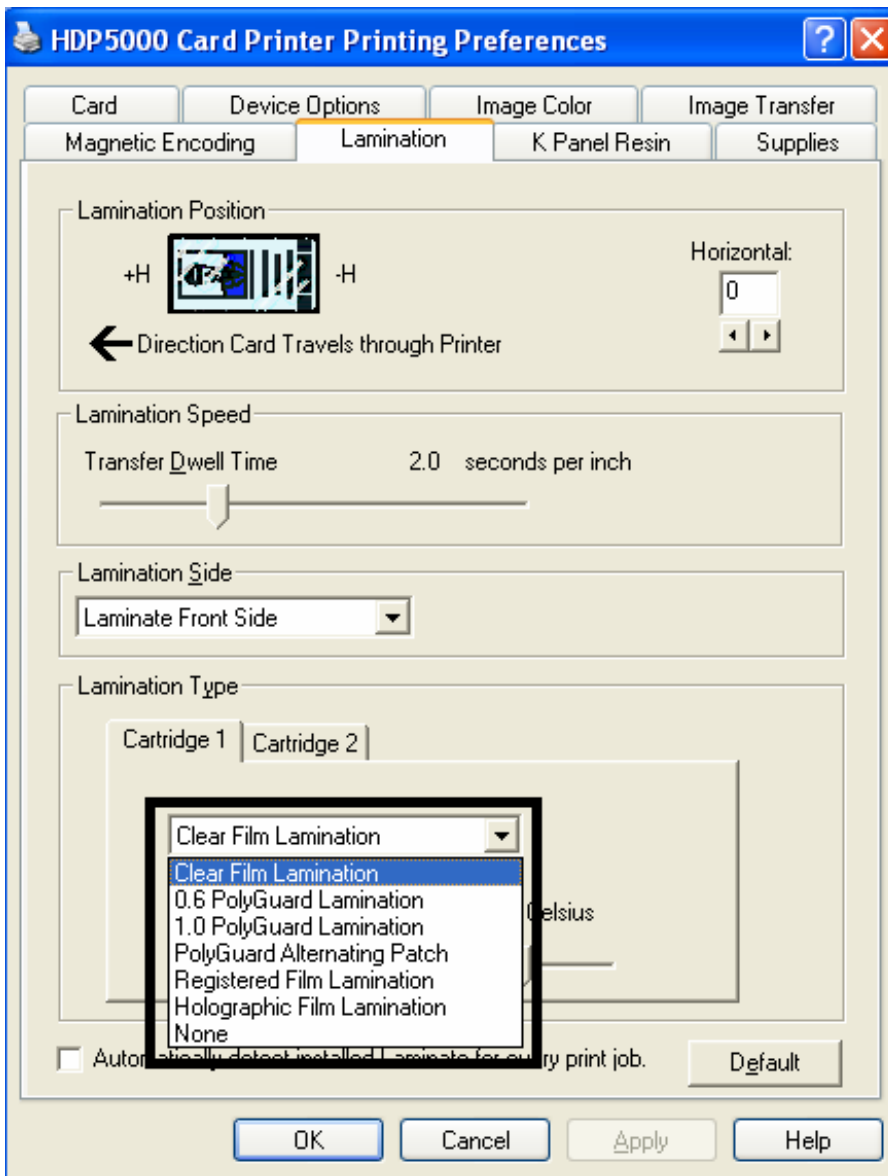

Selecting the Defaults button

Step	Procedure
1	Click on the Default button to return the Transfer Dwell Time and Transfer Temperature to the Default settings for the Lamination Type (being used).

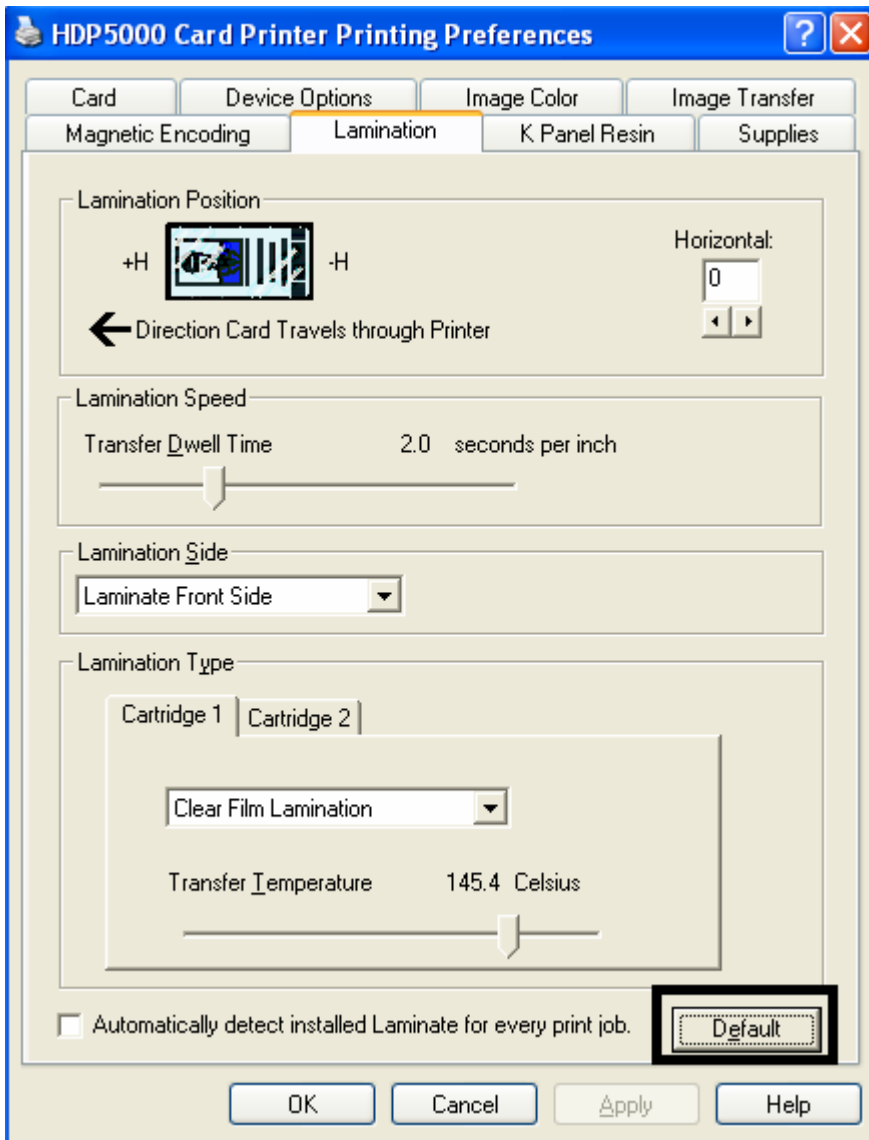

Using the K Panel Resin tab

Use this tab to adjust the Card Size, the Direction the Card Travels through the Printer, the Print All Black with K Panel (options) and the Defined Areas. Use this tab to control where the resin black (K) Panel of a full-color Ribbon is printed. (**Note:** When Disable Printing under the Device Options tab is selected, this tab will be active while all functions will be grayed out.)

- If printing with a Ribbon type that does not have a K Panel, such as the YMC Ribbon type, all K Panel Resin options will be grayed out. Resin black text is desirable due to its sharp, saturated color and resin black barcodes are required to ensure readability when scanned by an infrared barcode reader. (**Note:** The Printer Driver will automatically print all TrueType black text and TrueType barcodes only with the resin black (K) Panel of the Print Ribbon by default.)
- If printing black text or barcodes that are not TrueType fonts or black graphics, select one of the three options listed under **Print All Black with K Panel** (see the next page). (**Note:** The Printer Driver will print areas of the image where it finds black coloring with the Print Ribbon's resin black (K) Panel as specified by each of the following options.)

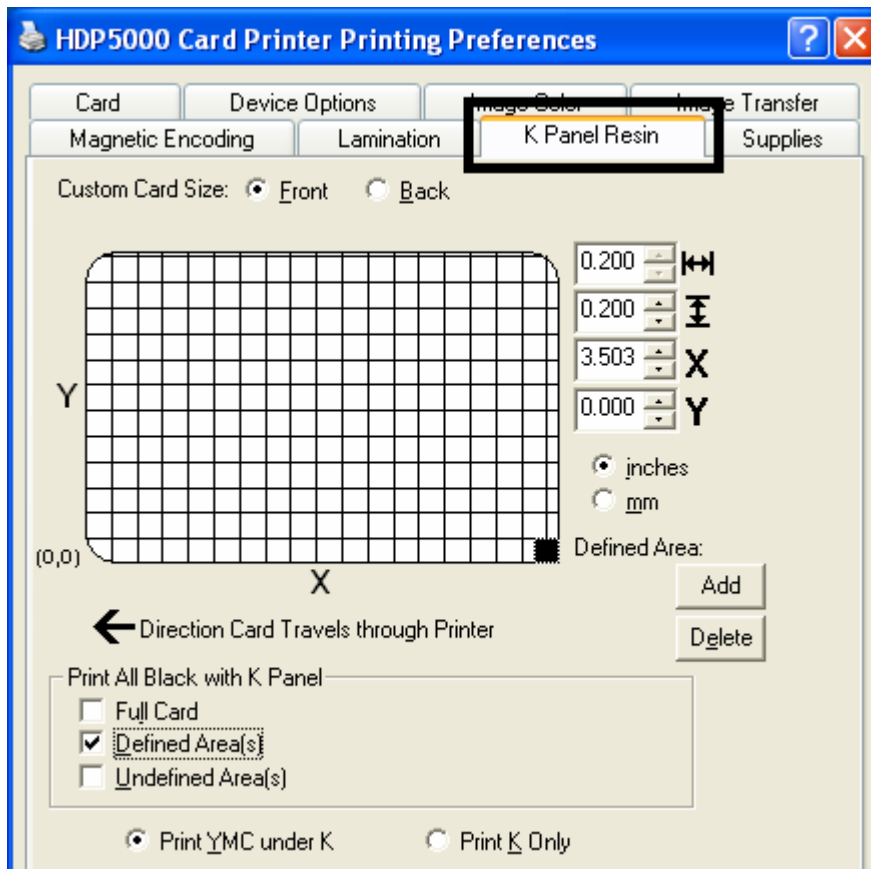

Using the Click and Drag capability

Click and drag the corners and the sides of an area to change size and location of area.

- The Horizontal, Vertical size and X, Y coordinates update accordingly.

Click and drag the area to change the location.

- The X, Y coordinates update accordingly.

Selecting “inches or mm” radio button

Select from the **inches** or **mm** radio button to change the measurement type. (**Note:** This is similar to the choice on the Card tab.)

- The **inches** radio button displays the area size and the location in inches.
- The **mm** radio button displays the area size and the location in mm.

Using the Add and Delete buttons

Step	Procedure
1	Use the Add button for these capabilities: <ul style="list-style-type: none"> • Add an area default sized to .2 (.2 at location “0” with focus on the added area). • Add multiple areas in the same location with the same affect (as if there were only one area). (Note: Intersecting/overlapping areas do not cancel each other out; instead, they act as one area.)
2	Using the Delete button to delete the area with focus from the graphic.

Selecting the Full Card

Step	Procedure
1	<p>Select the Full Card option to print the resin black (K) Panel for all black found within all areas of the image, as shown below.</p> <ul style="list-style-type: none"> • The Card image becomes fully black. • The resin prints anywhere for black. • The Add and Delete buttons become inactive and are grayed out. • The Defined Area object size and location scroll controls become inactive and are grayed out. • The inches and mm dials become inactive and are grayed out.

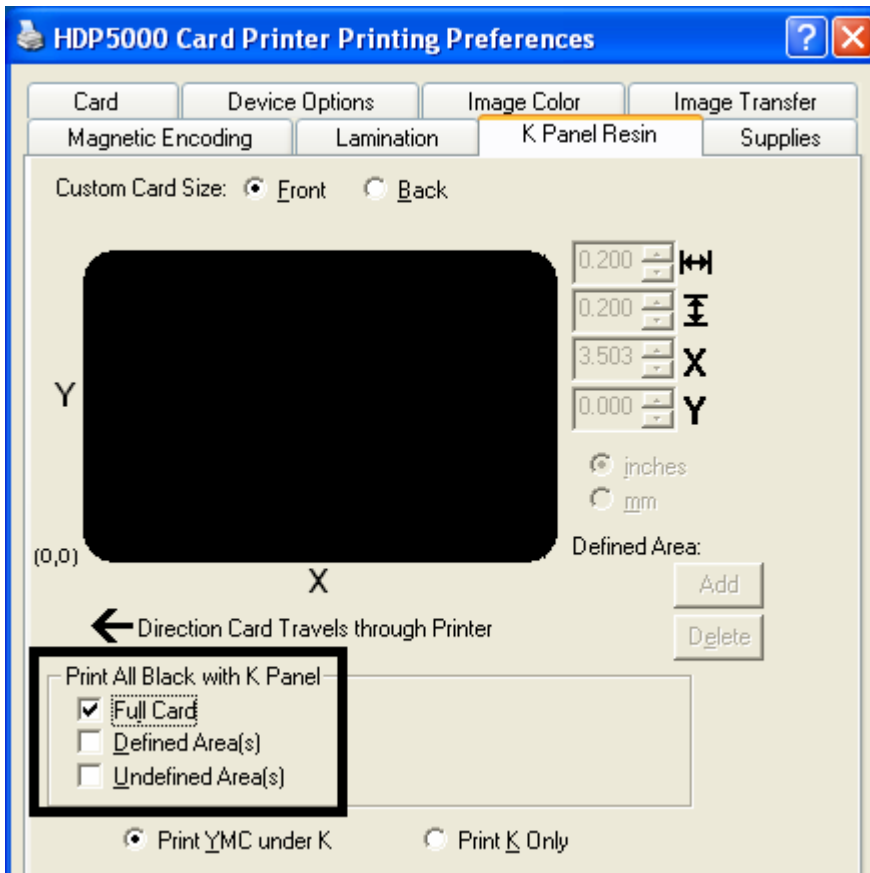

Selecting the Defined Area(s)

Step	Procedure
1	<p>Select the Defined Area(s) option to print the resin black (K) Panel for all black found only in an area or areas defined, as shown below.</p> <ul style="list-style-type: none"> The card image becomes white with the grid and one area (available for the User to start with). The defined areas print black with resin.

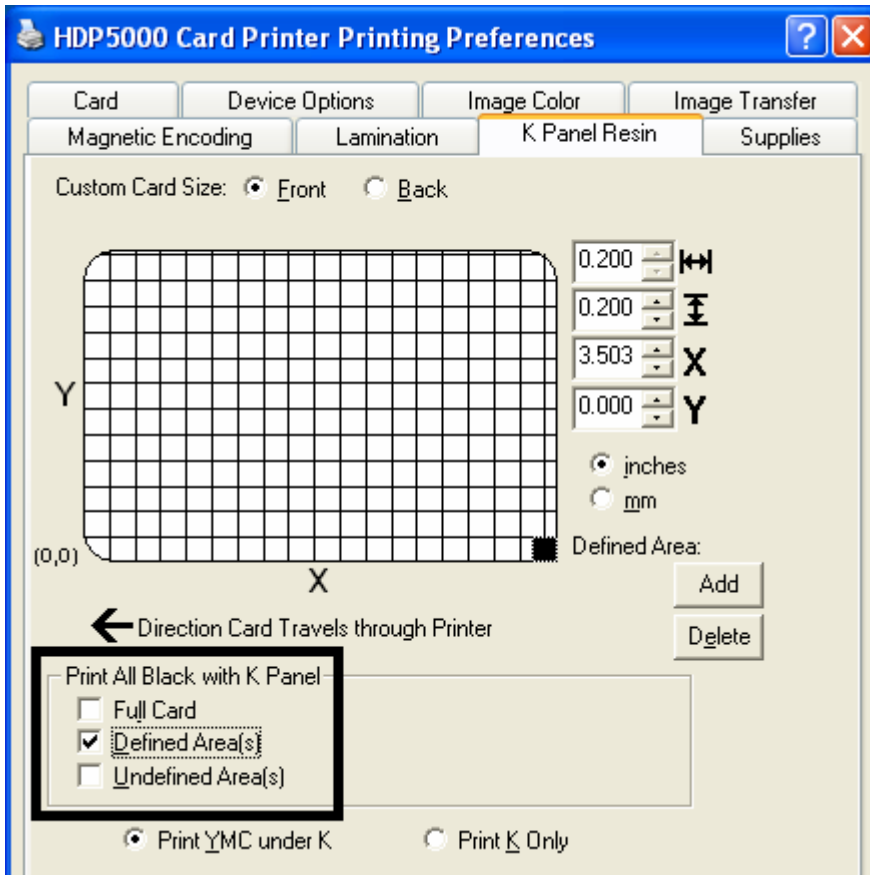

Selecting the Undefined Area(s)

Step	Procedure
1	<p>Select the Undefined Area(s) option to print the resin black (K) Panel for all black found only in the space outside the areas defined, as shown below.</p> <ul style="list-style-type: none"> The card image becomes black with the grid and one area (available for the User to start with). The defined area does not print black with resin.

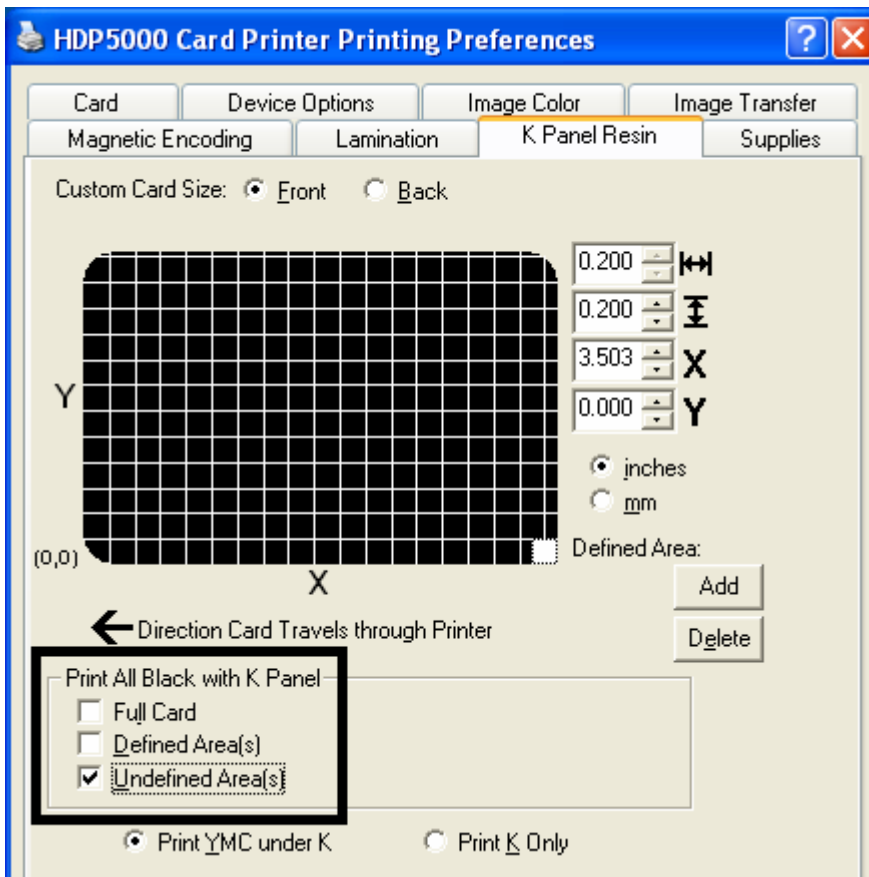

Defining the Area to activate the Card Grid

Step	Procedure
1	<p>Select on the appropriate Defined Area (see below) to activate the card grid in the upper half of the window.</p> <ul style="list-style-type: none"> It is through this card grid that up to five areas can be defined, as shown below. When the card grid is first activated, then a small black square will appear at its default size of .2 x .2 (5mm x 5mm) and at its default location in the lower left-hand corner (0,0). (Note: This square represents the first defined area.)

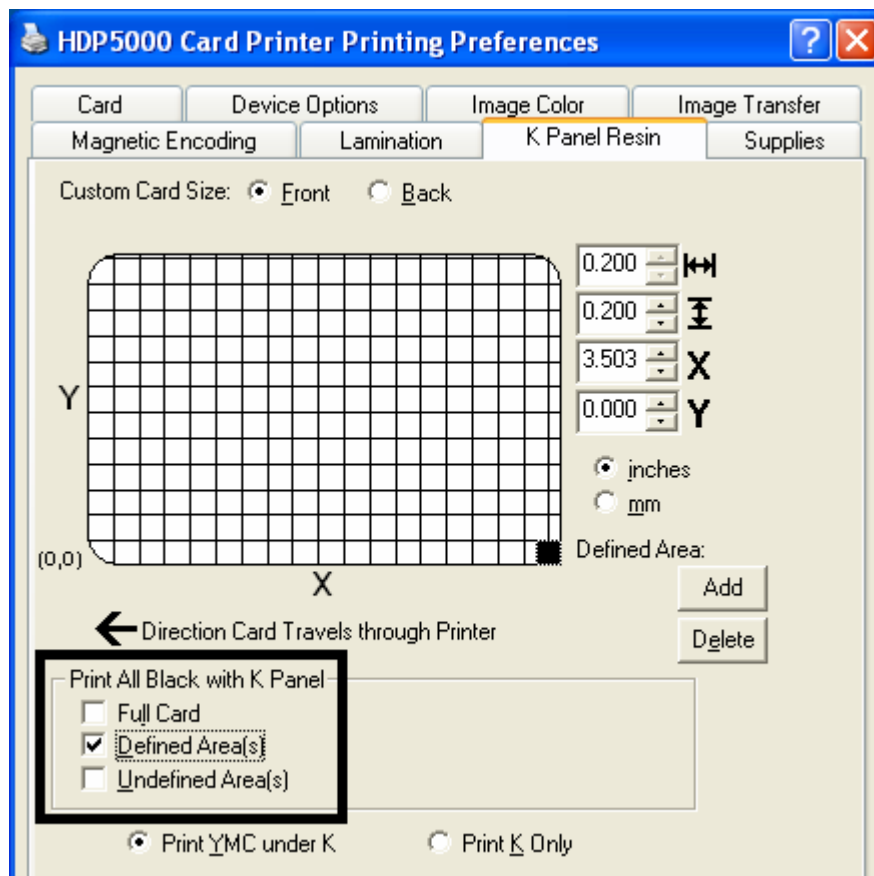

Selecting the Print YMC under the K and Print K Only options

Step	Procedure
1	<p>Use the Defined Area function.</p> <ol style="list-style-type: none"> a. Define another area by clicking on the Defined Area. (Note: Another .2 x .2 (5mm x 5mm) area will appear in the lower left-hand corner. This is the location in which all newly defined areas will first appear. Up to 5 areas can be defined.) b. Delete an area by selecting the area and clicking on the Delete button. (Note: If all areas are deleted, the K Panel Resin options will automatically be deselected.)
2	<p>Select the Print YMC Under K option to print all black in the designated Defined/Undefined areas with the Yellow (Y), Magenta (M) and Cyan (C) Ribbon Panels directly beneath the resin black (K) Panel. (Note: Select this option if printing resin black text or barcodes onto a colored background to provide a more gradual transition between the two.)</p> <p>OR</p> <p>Select the Print K Only option to print all black in the designated Defined/Undefined areas only with the resin black (K) Panel or to print resin black onto a white background to maximize the sharpness of printed text and barcodes.</p>

Selecting the Print YMC under the K and Print K Only options

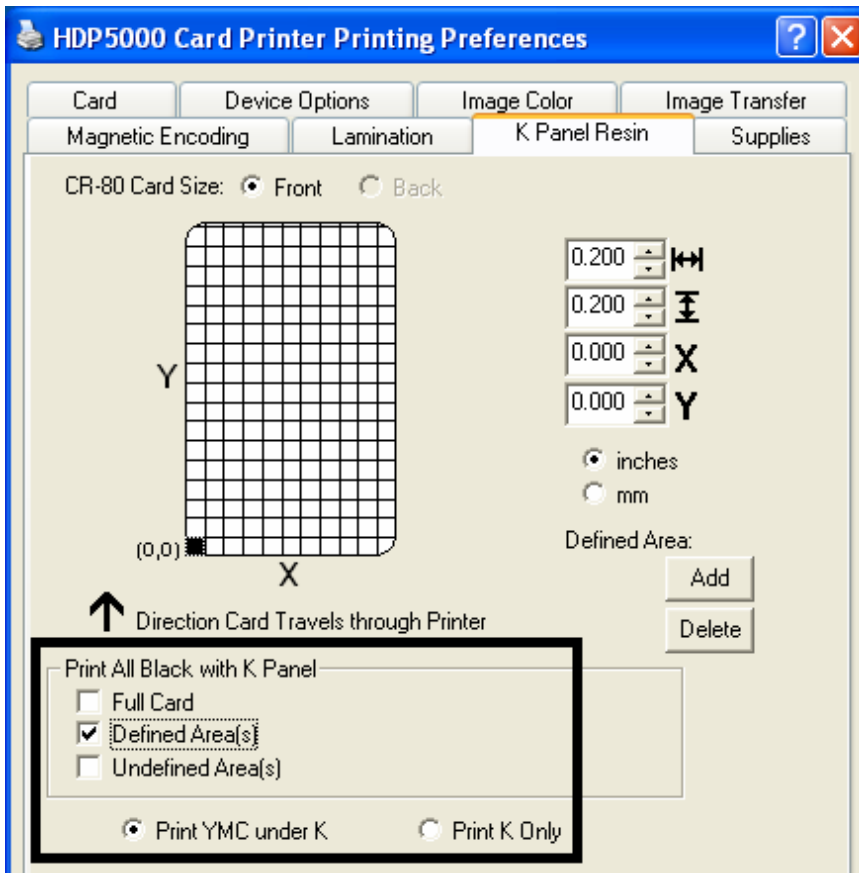

Using the Printer Supplies tab

Use the options on this tab to view information about the Ribbon, HDP Film, Laminate (Cartridge 1) and Laminate (Cartridge 2) installed in the Printer. (**Note:** The gauges are horizontal.)

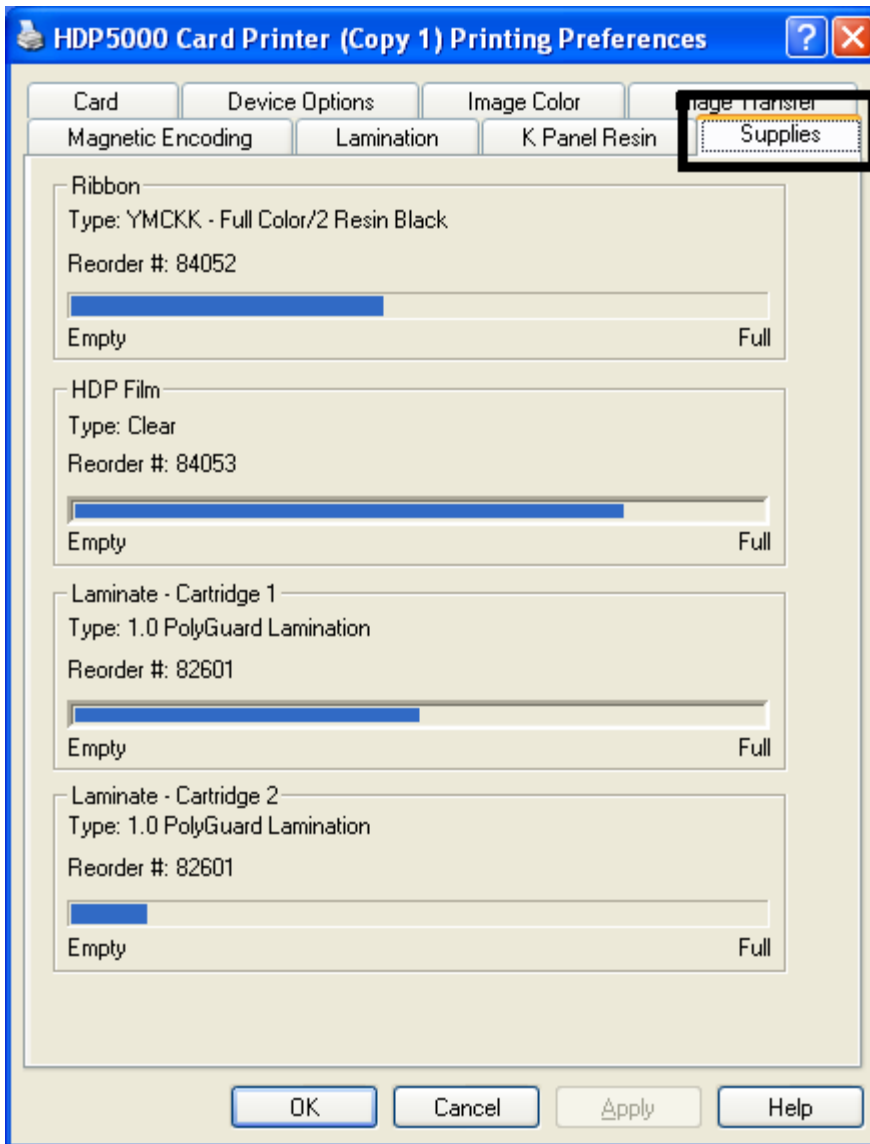

Reviewing Information on the Supplies tab

Here are the guidelines for automatic positioning on the Supplies tab.

Step	Procedure
1	<p>Use this tab to determine the following information (see below):</p> <ul style="list-style-type: none">• Ribbon Level: Type, Reorder Number and Gauge Indicator.• HDP Film Level: Type, Reorder Number and Gauge Indicator.• Lamination - Cartridge 1 Level: Type, Reorder Number and Gauge Indicator. (Note: This is visible only when the Laminate – Cartridge 1 is detected.)• Lamination – Cartridge 2 Level: Type, Reorder Number and Gauge Indicator. (Note: This is visible only when the Laminate – Cartridge 2 is detected.)

Section 5: Accessory Procedures

Using the Security Lock Slot on the HDP5000

Important: Compatible locks are not sold by HID Global; however, they are readily available from computer stores.

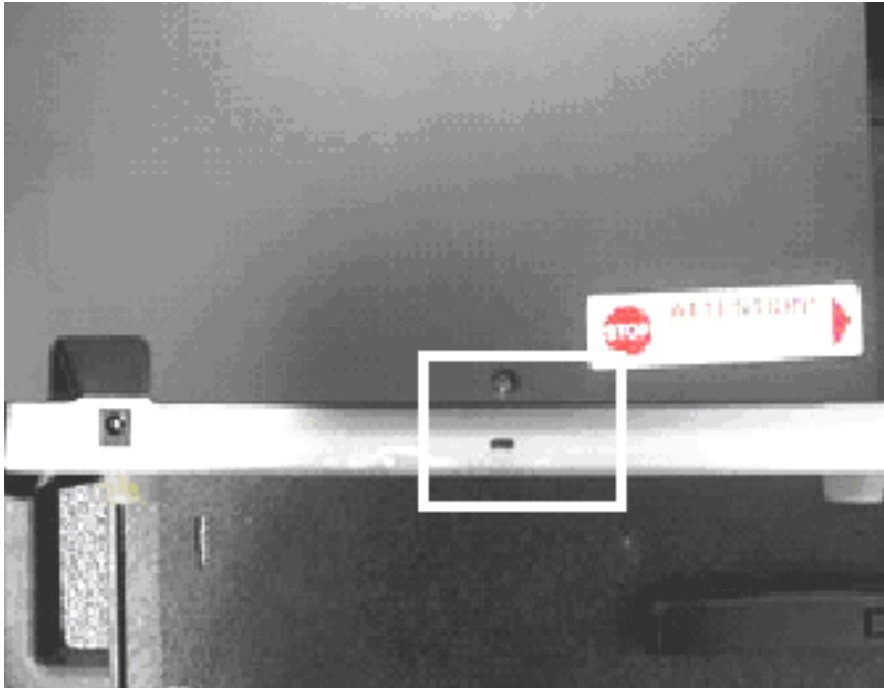

Using the Security Lock Slot on the HDP5000

The HDP5000 Printer has a Security Lock Slot located in the back lip of the metal chassis to accommodate a standard laptop security lock.

- To prevent unauthorized removal of the HDP5000, attach an industry standard security cable to an immovable object and then lock the cable to the Security Lock Slot. (**Note:** HID Global does not sell any type of locking device, but provides this feature for your added security.)
- The lock slot has a plastic covering that needs to be penetrated by the lock. (**Note:** Simply push the lock end into the slot with adequate force to break the protective film.)

Follow the locking procedure recommended by the lock vendor.



Installation and Removal Procedures Flipper Module Accessory

Removing the Output Side Upgrade Cover

Tools needed: Press the Release tab with a flat blade. Use the Snap and Clip process.

Estimated Repair Time: 1 minute

Step	Procedure
1	 Caution: Power off the Printer by unplugging the power cord from the Printer.
2	Press the release tab in back while simultaneously pulling at the center of the bottom edge.
3	Reverse instructions to re-assemble. Leave it off if your printer is upgraded for the Flipper or Lamination Module.

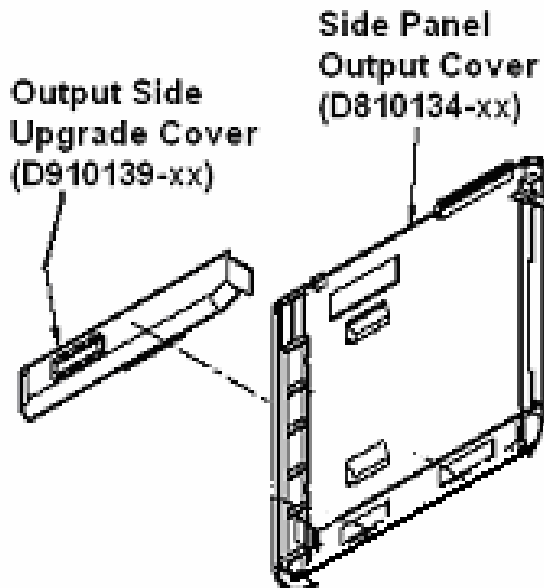

Installing the Flipper Module Accessory

Parts included: Flipper Module Accessory Kit, PCB-INTF Board, Torx tool and screws

Tools needed: Torx Tool (included in kit)

Estimated Repair Time: 20 minutes

Step	Procedure
1	 Caution: Power off the Printer by unplugging the power cord from the Printer.
2	Remove all USB, Serial, Ethernet communication connections. Remove the Card Output Hopper. Important: Do not remove the Covers for this procedure.
3	The Flipper Module is installed at the output side of the Printer. If there is a Lamination Module attached, the Flipper Module is placed in between the Printer and Lamination Module.
4	<ol style="list-style-type: none"> a. Remove the Output Side Upgrade Cover (D910139-01). b. Release the latch on the upgrade cover. c. Pull on the bottom of the upgrade cover to remove it from the printer.
5	<ol style="list-style-type: none"> a. Turn the Printer and the Flipper Module on their back. b. Use the Torx tool provided to remove the two (2) screws from the bottom of the Flipper Module. Save the screws for later for reattachment.
6	Position the Flipper Module attachment tabs and the PCB-INTF Board into the appropriate slots at the base of Printer. See Display A (below).
7	Use the two (2) screws to attach the Flipper Module to the Printer. Please refer to the pictures below.

Installing the Flipper Module Accessory

Display A - Slide the Flipper Module attachment tabs and the PCB-INTF Board into the appropriate slots at the base of Printer Module. This picture shows the Printer and the Flipper Module.

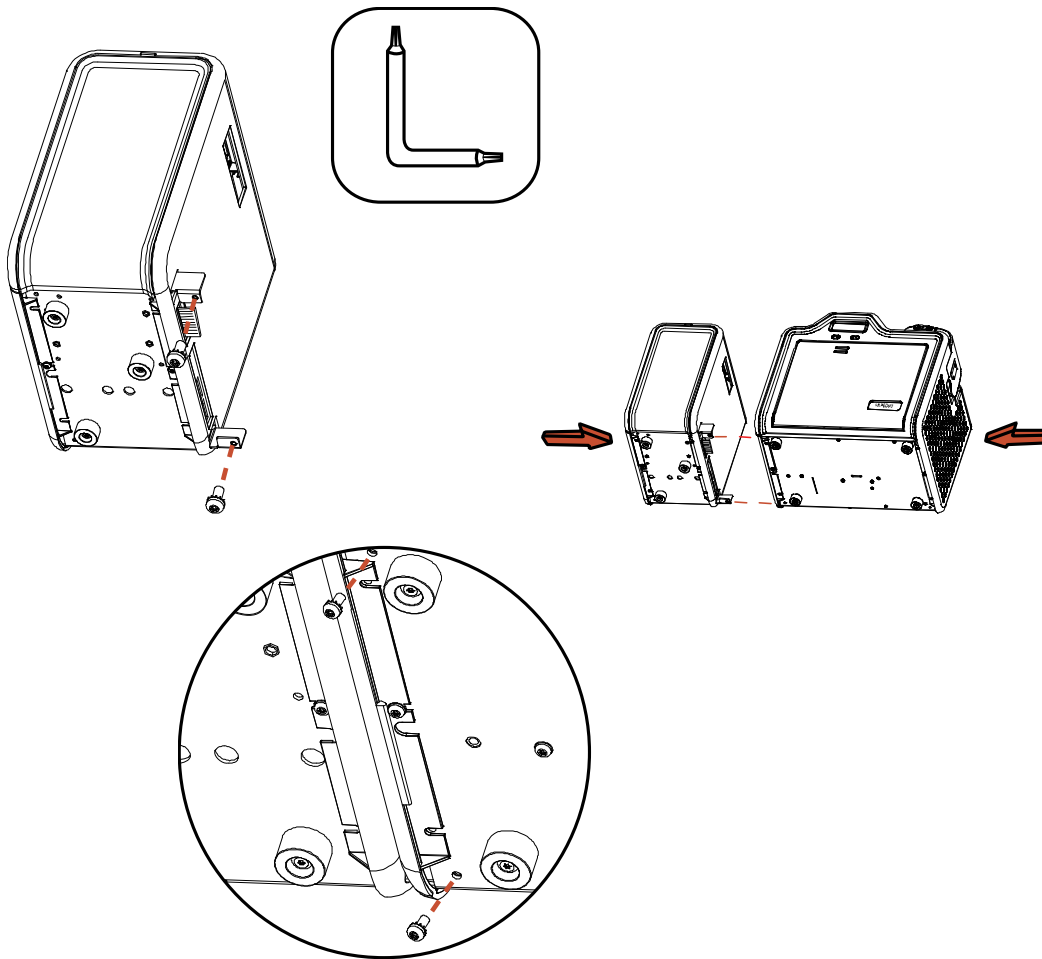

Section 6: General Troubleshooting

The purpose of this section is to provide the User with specific procedures relating to the LCD Messages, Communication Errors, Card Feeding Errors, Encoding Errors, Printing Process Errors, Transfer Process Errors and Diagnosing the Image Problems for the HDP5000.

Important! Fargo Card Printers require highly specialized print Ribbons to function properly. To maximize Printer life, reliability, printed card quality and durability, you must use only Fargo Certified Supplies. For this reason, your Fargo warranty is void, where not prohibited by law, if you use non-Fargo Certified Supplies. To order additional materials, please contact your authorized reseller.

Troubleshooting - LCD and Printer Error Message Tables.

The LCD display shows the current status of the Printer. Refer to the cause and solution tables in this section for all possible LCD messages.

This section provides two troubleshooting tables for the LCD error messages and the Printer error messages. Each table uses a 3-column presentation to present a specific LCD or Printer error message, its cause and its solution.

- This allows the troubleshooter to identify the error and its cause, and then perform the procedure (provided in the solution column).
- This standard mode of identifying the problem and its solution should provide an efficient method of troubleshooting this printer.
- If you encounter problems beyond the capabilities of these two error message tables, you should contact www.hidglobal.com

How to use the LCD Error Message Table (example provided)

The PC Error Message in Column 1 (LCD Error Message) provides the Lower Left Corner Number. This number identifies the PC Error Message screenshot with its respective LCD Error Message.

- Note the correlation between Column 1 (below) and the PC Error Message window (below).
- This allows you to correlate the LCD Error Message with the PC Error Message (identifying number), then troubleshoot your Printer as needed.

Display – Single Example from the LCD Error Message Table

LCD Error Message	Cause	Solution
Unable to Feed Card (PC Error Message Nos. <u>14</u> and 81) Matches with the screenshot below.	The Printer is unable to feed a card from the Card Cartridge.	Verify there are cards in the cartridge. Verify cards are not stuck together or jammed, and they are the correct thickness.

Display – Unable to Feed Card (screenshot; Lower Left Corner Number, 14)



Troubleshooting with the LCD Error Message Table

LCD Error Message	Cause	Solution
Calibrate Failed (PC Error Message No. 155 and 170)	Film or Ribbon calibration has failed.	Verify the film is installed correctly and there is not a Ribbon installed. If this problem persists, call for technical assistance.
Calibrate Film (PC Error Message No. 159)	Film Sensors need to be calibrated.	Select Cancel and then perform the Film calibration procedure.
Calibrate Ribbon (PC Error Message Nos. 128 and 170)	The print Ribbon Sensor is out of calibration.	Select Cancel and then perform the Ribbon calibration procedure.
Card Feed Stop (PC Error Message No. 137)	The Front Cover was opened. This caused the card transfer to stop OR the pause button was selected.	Press Resume or Cancel .
Card Jam (PC Error Message Nos. 82, 112, and 200)	A card is jammed in the Print Station or card flipping area of the Printer.	Clear the jam.
Card Jam: Prox (PC Error Message No. 86)	A card is jammed in the PROX card encoding area of the Printer.	Clear the jam.
Card Jam: Smart (PC Error Message No. 85)	A card is jammed in the smart card encoding area of the Printer.	Clear the jam.

Troubleshooting with the LCD Error Message Table

LCD Error Message	Cause	Solution
Card Jam: Trans (PC Error Message No. 83)	Card became jammed in the Printer during transfer.	Clear the jam.
Card Not Found (PC Error Message No. 69)	Card cannot be found in the Printer.	Verify card not jammed in Printer and select Cancel .
Check Film (PC Error Message No. 244)	The film is not able to move correctly. Check for jams/breaks.	Check for obstruction. If the problem persists, call for technical assistance.
Check Laminate 1 (PC Error Message Nos. 213 and 231)	The Laminator was unable to find the mark on the material in Cartridge 1.	Make sure there are no obstructions to the Sensor, and recalibrate the Laminator Sensor.
Check Laminate 2 (PC Error Message No. 232)	The Laminator was unable to find the mark on the material in Cartridge 2.	Make sure there are no obstructions to the Sensor, and recalibrate the Laminator Sensor.
Clean Printer (PC Error Message No. 71)	For best Printer performance, replace the Cleaning Roller Tape and clean the Printer's Feed Rollers and Printhead at this time.	See Cleaning the Printer .

Troubleshooting with the LCD Error Message Table

LCD Error Message	Cause	Solution
Cover is Open (PC Error Message No. 46)	The Cover was left open.	Ensure that the Cover is properly closed.
E-Card Encoder Startup Error (PC Error Message No. 141)	A problem was detected during Printer start-up.	Reset the Printer and try again. If this problem persists, call for technical assistance.
E-Card Startup Error (PC Error Message No. 141)	A problem was detected during Printer start-up.	Reset the Printer and try again. If this problem persists, call for technical assistance.
EEPROM Corrupt (PC Error Message Nos. 38, 39, 40, and 144)	EEPROM restored with factory default values.	If changes were made, then go into the setting values and reset these numbers.
Ejecting Card (PC Error Message No. 72)	The card has been ejected already.	Click OK to clear the message. The User might want to know that a card has been sent to the reject bin, or out of the printer, and is either incomplete or poses a security risk if not disposed of properly.

Troubleshooting with the LCD Error Message Table

LCD Error Message	Cause	Solution
Empty Reject Bin (PC Error Message No. 265)	The reject bin is full.	Remove the large number of rejected cards from the reject bin. Click OK to clear the notification message. (Note: In some cases, rejected cards are incomplete or pose a security risk, and should be disposed of properly.)
Failed To Initialize (PC Error Message No. 141)	A problem was detected during Printer start-up.	Reset the Printer and try again. If this problem persists, call for technical assistance.
Film Align Error (PC Error Message Nos. 26 and 176)	The film is not able to move correctly. Check for jams/breaks.	Check for obstruction. If the problem persists, call for technical assistance.
Film Break/Jam (PC Error Message No. 158)	The film is not able to move correctly. Check for jams/breaks.	Check for obstruction. If the problem persists, call for technical assistance.
Film Low (PC Error Message No. 156)	The HDP film will soon run out.	If printing a large number of cards, replace the Film now or monitor the Printer until the Film is gone and install a new Film.
Film Out (PC Error Message Nos. 156 and 157)	The HDP film has run out.	Install a new roll of film and press Resume to continue or Cancel to reset.

Troubleshooting with the LCD Error Message Table

LCD Error Message	Cause	Solution
Film: Wrong Material (PC Error Message No. 173)	The HDP Film is not installed properly or has been damaged.	Verify the correct film is installed in the film Cartridge.
Flipper Jam (PC Error Message Nos. 74 and 199)	A card is jammed in the card flipping area of the Printer.	<p>Open the Printer's Flipping Module Cover.</p> <p>Clear any cards in the Flipping Module by opening the Printers Cover and using the Forward and/or Back buttons located on the Printer's Front Cover.</p> <p>Ensure that the Flipper Module can rotate freely. Close the Printer's Flipping Module Cover.</p> <p>Press the Resume button on the Printer's Front Cover to continue printing.</p> <p>To cancel the print, press the Cancel Print button from the Driver's display dialog.</p>
Head Loading (PC Error Message No. 111)	An unrecoverable error has occurred during printing.	Reset the Printer and try again. If this problem persists, call for technical assistance.

Troubleshooting with the LCD Error Message Table

LCD Error Message	Cause	Solution
Head Resistance (PC Error Message No. 6)	The EE setting in Driver for head resistance is out of range.	Enter a value for head resistance in the EE settings in the Driver. Reset the correct value according to the steps in the Troubleshooting Section. If this problem persists, call for technical assistance.
Head Sensor Error (PC Error Message No. 8)	The Printhead Temperature Sensor is not functioning or is not connected properly. OR The Printhead is not cooling properly.	If the problem persists, call for technical assistance.
Head Voltage Err (PC Error Message Nos. 103 and 105)	A hardware fault has prevented setting the correct Printhead voltage.	Reset the Printer and try again. If this problem persists, call for technical assistance.
Headlift Error (PC Error Message Nos. 102, 103, 104, and 105)	This is a problem with the Printhead Lift or Transfer Roller Headlift.	Reset the Printer and try again. If this problem persists, call for technical assistance.
Heater Error (PC Error Message No. 161)	The Transfer Heater Roller is too hot.	Reset the Printer and try again. If this problem persists, call for technical assistance.

Troubleshooting with the LCD Error Message Table

LCD Error Message	Cause	Solution
Invalid Film (PC Error Message Nos. 94, 95, 96, 164, 165, and 166)	An unauthorized film is installed in the Printer.	Get the correct Film from your dealer.
Invalid Password (PC Error Message No. 136)	Printing disabled at this time.	Press Cancel to abort this print job and then check security settings at host computer.
Invalid Ribbon (PC Error Message No. 93)	An unauthorized Ribbon is installed in the Printer.	Get the correct Ribbon from your dealer.
Job Data Error (PC Error Message No. 106)	The print data sent to the Printer is corrupt or has been interrupted.	Reset the Printer and try again. If this problem persists, call for technical assistance.
Lam 1 Tag Err (PC Error Message No. 259)	A RFID read or write error occurred on Cartridge 1.	Retry, and if it fails again the material cannot be used.
Lam 2 Tag Err (PC Error Message No. 260)	A RFID read or write error occurred on Cartridge 2.	Retry, and if it fails again the material cannot be used.
Lam Async Error (PC Error Message No. 245)	The Printer timed out waiting for communication from the Laminator.	Check Lam power/connections and restart the Printer.

Troubleshooting with the LCD Error Message Table

LCD Error Message	Cause	Solution
Lam Card Jam (PC Error Message No. 53, 212, 214, and 215)	A jam occurred somewhere between the Printer and the Laminator.	Open covers and clear the obstruction/jam.
Lam Check Card (PC Error Message No. 213)	A jam occurred inside the Laminator.	Open Lam cover and clear the obstruction.
Lam Com Error (PC Error Message No. 246)	There was a communication failure between the Printer and Laminator.	Check Lam power/connections and restart the Printer.
Lam Error (PC Error Message Nos. 237 and 238)52	A generic unknown error as occurred.	Reset the Printer and try again. If this problem persists, call for technical assistance.
Lam Card Not Ejected (PC Error Message No. 216)	The card is not ejected from the Laminator.	The Lamination material is stuck to the card.
Lam Handler Startup Error (PC Error Message No. 66)	A problem was detected during Printer start-up.	Reset the Printer and try again. If this problem persists, call for technical assistance.

Troubleshooting with the LCD Error Message Table

LCD Error Message	Cause	Solution
Lam Handler Startup Error (PC Error Message No. 141)	After powering up the Printer, the Laminator was detected, but an error occurred which would prevent its use.	Check Laminator power and connections and restart the Printer.
Lam Internal Error (PC Error Message No. 48)	A generic unknown error as occurred in the Laminator.	Check Laminator power and connections and restart the Printer.
Lam No Film (PC Error Message No. 157)	There is no material loaded in the Laminator.	Load Laminator material.
Lam Timeout (PC Error Message No. 247)	The Printer timed out while processing information related to the Laminator.	Check Lam power/connections and restart the Printer.
Lam1 Wrong Film (PC Error Message No. 233)	Material in Cartridge 1 of the Laminator does not match the material type specified by the job.	Make sure Driver material matches what is actually in the Laminator.
Lam2 Wrong Film (PC Error Message No. 234)	Material in Cartridge 2 of the Laminator does not match the material type specified by the job.	Make sure Driver material matches what is actually in the Laminator.
Laminate 1 Bad (PC Error Message No. 259 and 261)	The Lamination material in Cartridge 1 is not valid for this Laminator.	Install valid material.

Troubleshooting with the LCD Error Message Table

LCD Error Message	Cause	Solution
Laminate 1 Jam (PC Error Message No. 229)	A Jam occurred with the Laminator material in Cartridge 1.	Open Lam cover and clear the obstruction
Laminate 1 Low (PC Error Message Nos. 239)	The material is getting low in Lamination Cartridge 1.	Make sure more is on hand for when it runs out.
Laminate 1 Out (PC Error Message No. 208)	The Laminate in Cartridge 1 has run out.	Replace it with a new roll of material.
Laminate 2 Bad (PC Error Message No. 260 and 262)	The Lamination material in Cartridge 2 is not valid for this Laminator.	Install valid material.
Laminate 2 Jam (PC Error Message No. 230)	A Jam occurred with the Laminator material in Cartridge 2.	Open Lam cover and clear the obstruction.
Laminate 2 Low (PC Error Message No. 240)	The material is getting low in Lamination Cartridge 2.	Make sure more is on hand for when it runs out.
Laminate 2 Out (PC Error Message No. 209)	The Laminate in Cartridge 2 has run out.	Replace it with a new roll of material.

Troubleshooting with the LCD Error Message Table

LCD Error Message	Cause	Solution
Lm1 Headlift Err (PC Error Message No. 217)	The Laminator failed to move or sense the lower (Lam module 1) head.	Check head connections and call for service/repair.
Lm2 Headlift Err (PC Error Message No. 218)	The Laminator failed to move or sense the upper (Lam Module 2) head.	Check head connections, call for service/repair.
Mag Encoder Paused (PC Error Message No. 143)	The Magnetic Encoder is in a pause state.	
Mag Encoder Startup Error (PC Error Message No. 63 and 141)	A problem was detected during Printer start-up.	Reset the Printer and try again. If this problem persists, call for technical assistance.
Mag Verify Error (PC Error Message No. 30)	Print could not verify MAG write. OR The magnetic stripe was not encoded properly.	Check the Cards and click on Cancel Print.
Multiple Feed (PC Error Message No. 70)	Multiple cards were fed into the Printer.	Remove all cards and try again.

Troubleshooting with the LCD Error Message Table

LCD Error Message	Cause	Solution
No E-card Encoder (PC Error Message No. 202)	You are trying to send encoding data, but the Printer is not configured with this Encoder type.	You are trying to send encoding data, but the Printer is not configured with this Encoder type.
No Film (PC Error Message No. 28)	Film is not installed in the Printer. OR Film RFID tag is bad.	Install the Film and press Resume . To cancel the print, press the Cancel Print button or the Cancel button located on the Printer.
No Flip Module (PC Error Message No. 201)	Two-sided job sent to a one-sided Printer.	Verify the Printer has flipper capabilities via the LCD Menu. If Flipper capabilities are present, ensure that the Print Both Sides option in the Driver is set correctly. Press the Resume button on the Printer's Front Cover to continue printing. To cancel the print, press the Cancel Print button from the Driver's display dialog.
No Flip Module (PC Error Message No. 45 and 201)	The desired lamination requires a Flipper Module.	Change the Cartridge location of the Lamination material (if it is dual sided), or buy a Flipper Module.

Troubleshooting with the LCD Error Message Table

LCD Error Message	Cause	Solution
No iClass Encoder (PC Error Message No. 177)	You are trying to send encoding data, but the Printer is not configured with this Encoder type.	You are trying to send encoding data, but the Printer is not configured with this Encoder type.
No Mag Module (PC Error Message No. 31)	MAG encoding job sent to Printer without a MAG Encoder. You are trying to send encoding data, but the Printer is not configured with this Encoder type.	
No MiFare Encoder (PC Error Message No. 203)	You are trying to send encoding data, but the Printer is not configured with this Encoder type.	To cancel, click on Cancel Print .
No Prox Encoder (PC Error Message No. 32)	You are trying to send encoding data, but the Printer is not configured with this Encoder type.	To cancel, click on Cancel Print .
No Ribbon (PC Error Message No. 25)	No Ribbon is installed in the Printer. OR The Ribbon RFID tag is bad.	Install the correct Ribbon and press the Resume button located on the Printer's LCD display. To cancel the print, press the Cancel Print button from the Driver's display dialog and the Cancel button located on the Printer's LCD display.

Troubleshooting with the LCD Error Message Table

LCD Error Message	Cause	Solution
No Smart Encoder (PC Error Message No. 33)	You are trying to send encoding data, but the Printer is not configured with this Encoder type.	To cancel, click on Cancel Print .
Printing Error (PC Error Message No. 107)	An error was detected during printing.	Reset the Printer and try again. If this problem persists, call for technical assistance.
Reboot Required (PC Error Message Nos. 9, 65, 67, and 163)	Unspecified system error detected by the Printer Firmware.	Reset the Printer and try again. If this problem persists, call for technical assistance.
Reinsert Ribbon (PC Error Message No. 141)	The Ribbon must be reinserted for proper functioning of the Printer.	Reinsert the Ribbon or press Resume .
Remove Card (PC Error Message No. 68)	A card is jammed in the Print Station or card flipping area of the Printer.	Clear the jam and press Cancel .
Remove Ribbon (PC Error Message No. 139)	The print Ribbon is not installed properly or has been damaged.	Verify the correct Ribbon is installed in the Ribbon Cartridge. Remove it and replace it with the correct Ribbon.
Remove Lam Mtl (PC Error Message No. 210)	Single Sided Lam job specified but the material is loaded in both Modules.	Remove either Lamination Cartridge.

Troubleshooting with the LCD Error Message Table

LCD Error Message	Cause	Solution
Remove Lam1 Mtl (PC Error Message No. 204)	Single sided lamination on the back side is specified but material is loaded in the Lam 1 Module.	Remove Cartridge 1.
Remove Lam2 Mtl (PC Error Message No. 205)	Single sided lamination on the front side is specified but material is loaded in the Lam 2 Module.	Remove Cartridge 2.
Ribbon Break/Jam (PC Error Message No. 99, 108, and 109)	The Ribbon is not able to find the next panel correctly. Check for jams/breaks.	If jammed, clear the jam. If broken, repair by taping the Ribbon back on to the take-up core. Press Resume to continue or Cancel to abort.
Ribbon Low (PC Error Message No. 92)	The print Ribbon will soon run out.	If printing a large number of cards, replace the Ribbon now or monitor the Printer until the Ribbon is gone and install a new Ribbon.
Ribbon Miscue (PC Error Message No. 97)	The Ribbon is not able to find the next panel correctly. Check for jams/breaks.	If jammed, clear the jam. If broken repair by taping the Ribbon back on to the take-up core. Press Resume to continue or Cancel to abort.
Ribbon Out (PC Error Message No. 91, 100 and 101)	The print Ribbon has run out.	Install a new Ribbon and press Resume to continue.

Troubleshooting with the LCD Error Message Table

LCD Error Message	Cause	Solution
Ribbon Tension (PC Error Message No. 98)	The Ribbon tensions may be out of range.	Check and adjust the setting through the TOOLBOX under the Advanced Settings tab. If this problem persists, call for technical assistance. Press Resume to continue or cancel to abort.
Ribbon: Wrong Material (PC Error Message No. 93, 122, and 172)	The print Ribbon is not installed properly or has been damaged.	Verify the correct Ribbon is installed in the Ribbon Cartridge.
System Fault (PC Error Message No. 164)	Unspecified system error is detected by the Printer Firmware.	Reset the Printer and try again. If this problem persists, call for technical assistance.
Unable to Feed (PC Error Message Nos. 14 and 81)	The Printer is unable to feed a card from the Card Cartridge	Verify there are cards in the Card Cartridge. Verify cards are not stuck together or jammed, and they are the correct thickness.
Utility Error (PC Error Message Nos. 129)	Command resulted in an error.	See Resolving the Communication Errors .

Troubleshooting with the LCD Error Message Table

LCD Error Message	Cause	Solution
Waiting for Data (PC Error Message No. 147)	The Printer has stopped receiving data from the PC.	Reset the Printer and try again. If this problem persists, call for technical assistance.
Wrong Film (PC Error Message Nos. 162 and 163)	The print film installed in the Printer does not match the film type selected in the Printer Driver. OR A Self-test job cannot be printed with the print media installed.	Replace film in Printer with type specified in the Driver. A reboot is required.
Wrong Ribbon (PC Error Message No. 93)	The print Ribbon installed in the Printer does not match the Ribbon type selected in the Printer Driver. OR A Self-test job cannot be printed with the print media installed.	Replace Ribbon in Printer with type specified in the Driver.

Troubleshooting with the Printer Error Message Table

Printer Error Message	Cause	Solution
General Error	A general Printer error has occurred.	Press Cancel on the printer or click on Cancel Print .
Card Not Found	The Printer is unable to find the card.	Please check Printer for a card or other obstruction, remove the card and cancel the print by pressing the Cancel Print button from the Driver's display dialog or the Cancel button, located on the Printer.
Cover Open	The Printer cannot start printing because the Cover is open.	Close the Cover to continue printing.
Unable to Feed Card	The Printer is unable to feed a card from the Card Cartridge.	Ensure that cards are available and loaded correctly, press the Resume button located on the Printer's LCD display to continue printing. To cancel the print, press the Cancel Print button from the Driver's display dialog and the Cancel button located on the Printer's LCD display.

Troubleshooting with the Printer Error Message Table

Printer Error Message	Cause	Solution
Card Jam	A Card has become jammed in the Printer.	<ol style="list-style-type: none"> a. Open the Printer's Front Cover and remove the Print Ribbon and Film Cartridges. b. Clear any cards in the printer by using the Forward and/or Back Buttons located on the printer's LCD display. c. Re-insert the Ribbon and close the Printer's Front Cover. d. Press the Resume button located on the Printer's LCD display to continue printing. e. To Cancel the print, press the Cancel Print button from the Driver's display dialog and the Cancel button located on the Printer's LCD display.
Card Jam (Encoder)	A Card has become jammed in the Printer's Encoding station.	<ol style="list-style-type: none"> a. Open the Printer's Front Cover and remove the Print Ribbon. b. Open the Printer's Flipping Module Cover. c. Clear any cards in the Encoding Module by using the Forward and/or Back buttons located on the Printer's LCD display. d. Re-insert the Print Ribbon and close the Printer's Front Cover. e. Press the Resume button located on the Printer's LCD display to continue printing. f. To cancel the print, press the Cancel Print button from the Driver's display dialog or the Cancel button located on the Printer's LCD display.

Troubleshooting with the Printer Error Message Table

Printer Error Message	Cause	Solution
Card Jam (Flipper)	A Card has become jammed in the Printer's Flipper Table.	<ol style="list-style-type: none"> a. Open the Printer's Front Cover and the Flipper Module Cover. b. Clear any cards in the Flipper Table by using the Forward and/or Back buttons located on the Printer's LCD display. c. Close the Printer's Front Cover. d. Press the Resume button located on the Printer's LCD display to continue printing. e. To cancel the print, press the Cancel Print button from the Driver's display dialog or the Cancel button on the Printer's LCD display.
Card Jam (Laminator)	A Card has become jammed in the Printer's Lamination Module.	<ol style="list-style-type: none"> a. Open the Printer's Module's Front Cover and remove the Overlaminates. b. Clear any cards in the Lamination Module by using the Forward Arrow and/or Back Arrow buttons located on the Printer's LCD display. The Printer's Front Cover must be open for use of the Forward and Back buttons. c. Re-insert the Overlaminates and close the Lam Module's Front Cover. d. Press the Resume button located on the Printer's LCD display to continue printing. e. To cancel the print, press the Cancel Print button from the Driver's display dialog or the Cancel button on the Printer's LCD display.

Troubleshooting with the Printer Error Message Table

Printer Error Message	Cause	Solution
Card Eject Error	The Printer is unable to eject a card.	<p>Please check Printer for a card jam or other obstruction and press the Resume button located on the Printer's LCD display to continue printing.</p> <p>To cancel the print, press the Cancel Print button from the Driver's display dialog or the Cancel button located on the Printer's LCD display.</p>
Flipper Jam	The Flipper Table has jammed while either aligning itself or flipping a card.	<ol style="list-style-type: none"> a. Open the Printer's Flipper Module Cover. b. Clear any cards in the Flipper Module by using the Forward and/or Back buttons located on the Printer's Front Cover. c. Ensure that the Flipper Table can rotate freely. Close the Printer's Flipper Module Cover. d. Press the Resume button on the Printer's Front Cover to continue printing. e. To cancel the print, press the Cancel Print button from the Driver's display dialog.

Troubleshooting with the Printer Error Message Table

Printer Error Message	Cause	Solution
No Flipper	The Printer does not have flipping capabilities.	<ul style="list-style-type: none"> a. Verify the Printer has flipper capabilities via the LCD Menu. b. If Flipper capabilities are present, ensure that the Print Both Sides option in the driver is set correctly. c. Press the Resume button on the Printer's Front Cover to continue printing. d. To cancel the print, press the Cancel Print button from the Driver's display dialog or press the Cancel button located on the Printer's LCD display.
Ribbon RFID Error	The ribbon tag information is corrupted or incorrect.	<p>Check that the Ribbon is installed properly. Cancel is the only option.</p> <p>Press the Cancel Print button from the Driver's display dialog, or the Cancel button located on the Printer's LCD display.</p>
Wrong Ribbon Installed	An incorrect ribbon has been installed, or a driver setting is incorrect.	<p>Check that the ribbon is correct for the printer and job. Press the Resume button located on the Printer's LCD display to continue printing.</p> <p>To cancel the print, press the Cancel Print button from the Driver's display dialog, or the Cancel button located on the Printer's LCD display.</p>

Troubleshooting with the Printer Error Message Table

Printer Error Message	Cause	Solution
No Ribbon Installed	No Print Ribbon is installed in the Printer.	Install the correct Ribbon and press Resume on the LCD display.
Ribbon Out	The Print Ribbon installed in the printer is empty.	Install a new Ribbon and press Resume on the LCD display.
Ribbon Break/Jam	A Ribbon break/jam has been detected inside the Printer.	<p>The printer has determined that the installed ribbon has either jammed or broken.</p> <ol style="list-style-type: none"> a. Open the Printer Cover and remove the Print Ribbon. If ribbon is jammed, remove jam and tighten ribbon. b. Clear any cards in the printer by using the Forward and/or Back buttons located on the Printer's LCD display. c. Tape the ends of the Ribbon together and wind any excess onto the Take-up Spool of the Print Ribbon. d. Re-install the Print Ribbon, close the Printer Cover and press the Resume button located on the Printer's LCD display to continue printing. e. To cancel the print, press the Cancel Print button from the Driver's display dialog and the Cancel button located on the Printer's LCD display.

Troubleshooting with the Printer Error Message Table

Printer Error Message	Cause	Solution
Ribbon Miscue	A Ribbon Miscue has been detected inside the Printer.	<p>Open the Printer's Cover and remove the Print Ribbon. Check the Ribbon and see if it is broken.</p> <ol style="list-style-type: none"> If the Print Ribbon is not broken, re-install the Print Ribbon, close the Printer's Cover and press the Resume button on the Printer to continue printing. If the Print Ribbon is broken, tape the ends of the Print Ribbon together and wind any excess onto the Take-up Spool. Re-install the Print Ribbon, close the Printer's Cover and press the Resume button on the Printer to continue printing. To cancel the print, press the Cancel Print button on the Driver's display dialog or the Cancel button on the printer.
Ribbon Sensor Error	The Printer cannot find the next panel on the Print Ribbon.	<p>Recalibrate the Ribbon Sensor using the Calibrate Ribbon Tab within the Toolbox.</p> <p>To cancel the print, press the Cancel Print button from the Driver's display dialog and the Cancel button on the Printer's LCD display.</p>

Troubleshooting with the Printer Error Message Table

Printer Error Message	Cause	Solution
Invalid Ribbon	An incorrect Print Ribbon has been installed in the Printer. (This is if you are using a SecureMark Ribbon).	<p>A non-SecureMark Ribbon is installed in a SecureMark Printer.</p> <ol style="list-style-type: none"> Replace with the appropriate SecureMark Ribbon and press the Resume button located on the Printer's LCD display to continue printing. To cancel the print, press the Cancel Print button from the Driver's display dialog and the Cancel button located on the Printer's LCD display. Install a Certified Print Ribbon and press the Resume button located on the Printer's LCD display to continue printing. To cancel the print, press the Cancel Print button from the Driver's display dialog and the Cancel button located on the Printer's LCD display.
Invalid Ribbon	The ribbon installed does not match the SecureMark configuration of the printer.	<p>Install a Certified Print Ribbon and press the Resume button located on the Printer's LCD display to continue printing.</p> <p>To cancel the print, press the Cancel Print button from the Driver's display dialog and the Cancel button located on the Printer's LCD display.</p>

Troubleshooting with the Printer Error Message Table

Printer Error Message	Cause	Solution
Invalid Ribbon	An incorrect Print Ribbon has been installed in the Printer.	Check that the ribbon is correct for the printer and retry. To cancel, click on Cancel Print .
Ribbon Error	The Print Ribbon caused a general error.	Press the Resume button located on the Printer to continue. To cancel, press the Cancel Print button or the Cancel button located on the Printer.
No Magnetic Encoder Installed	A print job with Magnetic encoding was sent with no Magnetic Encoder installed in the printer.	Ensure that no encoding data is being sent with the print job and reprint the card.
Mag Verify Error	The printer is unable to verify encoded data.	Check the Cards and click on Cancel Print .
No Mag Strip Present	The Printer is unable to find a Magnetic stripe on the card.	Check the Cards and click on Cancel Print .
No Smart Card Encoder	No Smart Card Encoder is installed in the printer.	To cancel, click on Cancel Print .

Troubleshooting with the Printer Error Message Table

Printer Error Message	Cause	Solution
No Prox Card Encoder	No Proximity Card Encoder is installed in the printer.	To cancel, click on Cancel Print .
Headlift Error	The Headlift Sensor is not detecting movement from the Headlift Cam.	Reboot the Printer by cycling power. To cancel, press the Cancel Print button.
Invalid Password	The Password entered is not a valid password.	Press OK to enter another password. To cancel, press the Cancel Print button.
Laminator (General Error)	The Laminator has reported a general fault.	Press the Resume button located on the Printer to continue. To cancel, press the Cancel Print button or the Cancel button located on the Printer.
Laminator (Check Power)	The Laminator's power is OFF.	Ensure that the laminator's power cord is properly connected, cycle power and press the Resume button to continue. To cancel, press the Cancel Print button or the Cancel button located on the Printer.

Troubleshooting with the Printer Error Message Table

Printer Error Message	Cause	Solution
Laminator (Heater Off)	The Laminator's Heater is OFF.	<p>Press the Resume button to continue.</p> <p>To cancel, press the Cancel Print button or the Cancel button located on the Printer.</p>
Laminator (Heater Timed Out)	The Laminator cannot reach the desired operating temperature.	<ol style="list-style-type: none"> Reboot the Printer by cycling power. Check the Laminator settings in the Printer Driver. Click on the Default button located on the Lamination Tab of the driver to set the Laminator settings to the factory default. Resend the print job. To cancel, press the Cancel Print button or the Cancel button located on the Printer.
No Laminator Film Installed	No laminator Film is installed in the laminator unit.	<p>Ensure that the appropriate Laminator Film is installed.</p> <p>To cancel the print, press the Cancel Print button or the Cancel button located on the Printer.</p>

Troubleshooting with the Printer Error Message Table

Printer Error Message	Cause	Solution
Wrong Laminator Film Installed	An incorrect laminator film has been installed, or a driver setting is incorrect.	<p>Ensure that the appropriate Laminator Film is installed and press the Resume button located on the Printer to continue printing.</p> <p>To cancel, press the Cancel Print button or the Cancel button located on the Printer.</p>
Laminator Film Out	The Film installed in the laminator is empty.	The Film installed in the laminator is empty.
Laminator Film Break/Jam	A Film break/jam has been detected inside the Laminator.	<p>The printer has determined that one or both overlaminates have either jammed or broken.</p> <ol style="list-style-type: none"> Open the Laminator Cover and remove the Laminator Cartridge(s). If overlaminates are jammed, remove the jam and tighten the material. Clear any cards in the printer by using the Forward and/or Back buttons located on the Printer's LCD display. Tape the ends of the overlaminates together and wind any excess onto the Take-up Spool of the Overlaminates. Re-install the Laminator Cartridge(s), close the Laminator Cover and press the Resume button located on the Printer's LCD display to continue printing. To cancel the print, press the Cancel Print button from the Driver's display dialog and the Cancel button located on the Printer's LCD display.

Troubleshooting with the Printer Error Message Table

Printer Error Message	Cause	Solution
Laminator Film Sensor Error	The Laminator cannot find the next panel on the Film.	Check that the Film is installed properly and press Resume . To cancel, press the Cancel Print button or the Cancel button located on the Printer.
Remove Laminator Film	To continue, remove the laminator's film.	Open the Laminator's Front Cover. Remove the film and close the Laminator's Front Cover.
Print Film Out	The Print Film installed in the printer is empty.	Install new Film and press the Resume button to continue printing. To cancel the print, press the Cancel Print button or the Cancel button located on the Printer.
Print Film is not Installed	No Print Film is installed in the Printer.	Install the Film and press Resume . To cancel the print, press the Cancel Print button or the Cancel button located on the Printer.
Print Film Sensor Error	The Printer cannot find the next panel on the Print Film.	Check that the Print Film is installed properly and press Resume . To cancel the print, press the Cancel Print button or the Cancel button located on the Printer.

Troubleshooting with the Printer Error Message Table

Printer Error Message	Cause	Solution
Wrong Print Film Installed	An incorrect Print Film has been installed, or a driver setting is incorrect.	<p>Ensure that the appropriate Print Film is installed and press the Resume button located on the Printer to continue printing.</p> <p>To cancel, press the Cancel Print button or the Cancel button located on the Printer.</p>
Invalid Print Film Installed	The Print Film installed does not match the SecureMark configuration of the printer.	<p>A non-SecureMark Film is installed in a SecureMark Printer.</p> <p>Replace with the appropriate SecureMark Film and press the Resume button on the Printer to continue printing.</p> <p>To cancel, press the Cancel Print button or the Cancel button on the Printer.</p>
Print Film Error	The Print Film caused a general error.	<p>Ensure that the appropriate Print Film is installed and press the Resume button located on the Printer to continue printing. To cancel, press the Cancel Print button or the Cancel button.</p>

Communications Errors

Resolving the Communication Errors

Symptom(s): Incorrect output, communications error on PC or Printer, stalling, no response from Printer, no job printed, “paper out” error.

Step	Procedure
1	Confirm that the system meets the minimum requirements, as shown here: <ul style="list-style-type: none"> • IBM-PC or compatible. • Windows 32 bit 2000/XP, Pentium™ class 500 MHz computer with 256 MB of RAM or higher • 500 MB free hard disk space or higher • USB Port (Optional Ethernet connection)
2	Confirm the correct installation of the Printer Driver. <ol style="list-style-type: none"> a. Close the software program and check the Printer Driver. b. Reboot the computer. c. Ensure the Printer Driver is installed correctly. (Note: This pertains especially if an obsolete Driver was recently removed.) Ensure the correct setup options within the Printer Driver are selected. Confirm that the Driver is current by checking at: www.hidglobal.com
3	Confirm the correct installation of the Flipper Table Module Assembly. <ol style="list-style-type: none"> a. Reboot the computer. b. Ensure that the Print Both Sides option in the Printer Driver is set correctly. c. Verify the Flipper Table Module Assembly is functioning properly by printing out cards in a test run.

Resolving the Communication Errors

Step	Procedure
4	<p>Determine the problem with printing from the application.</p> <ol style="list-style-type: none"> a. Print a self-test from the Printer by pressing Options -> Menu-> Select -> Print on the printer's LCD to ensure that the Printer (itself) is functioning properly. See the next procedure. b. Print the Windows test page that is located in the General tab of the Driver. c. Use WordPad (a Windows 2000/XP word processing program in the Accessories Program Group). <ol style="list-style-type: none"> 1) Go to the File menu and select Page Setup. 2) Click on the Printer button and select the HDP5000 Card Printer. 3) Click OK and reset all four margins to zero. (Note: The WordPad will automatically replace the values with its minimum margins.) 4) Open the program and type: "This is a Test." then, go to File on the menu bar and select Print.
5	<p>Determine whether there is adequate hard Drive space.</p> <p>(Note: A large volume of temporary files on the computer can cause communications errors.)</p> <ol style="list-style-type: none"> a. Access the temporary files by following this process: <ul style="list-style-type: none"> • Search for all folders called TEMP. Once found, clear out the contents of the folders. • If using Windows 2000/XP/2003 run the System Utility - Disk Defragmenter found in the Accessories folder of the Start Menu. • Use a disk cleanup utility (such as Disk Cleanup found in the System Tools folder of the Start menu) or use a third party application.

Printing a Test Image using the Workbench Diagnostic

Step	Procedure
1	Open the Diagnostic Tool from the Driver. Choose Run Tests to select a preset test image. Select Self Tests (Note: These images help to determine if the Printer is functioning properly.)
2	Scroll to the desired Self Test image from the Choose Test window options and press the Run Test button.

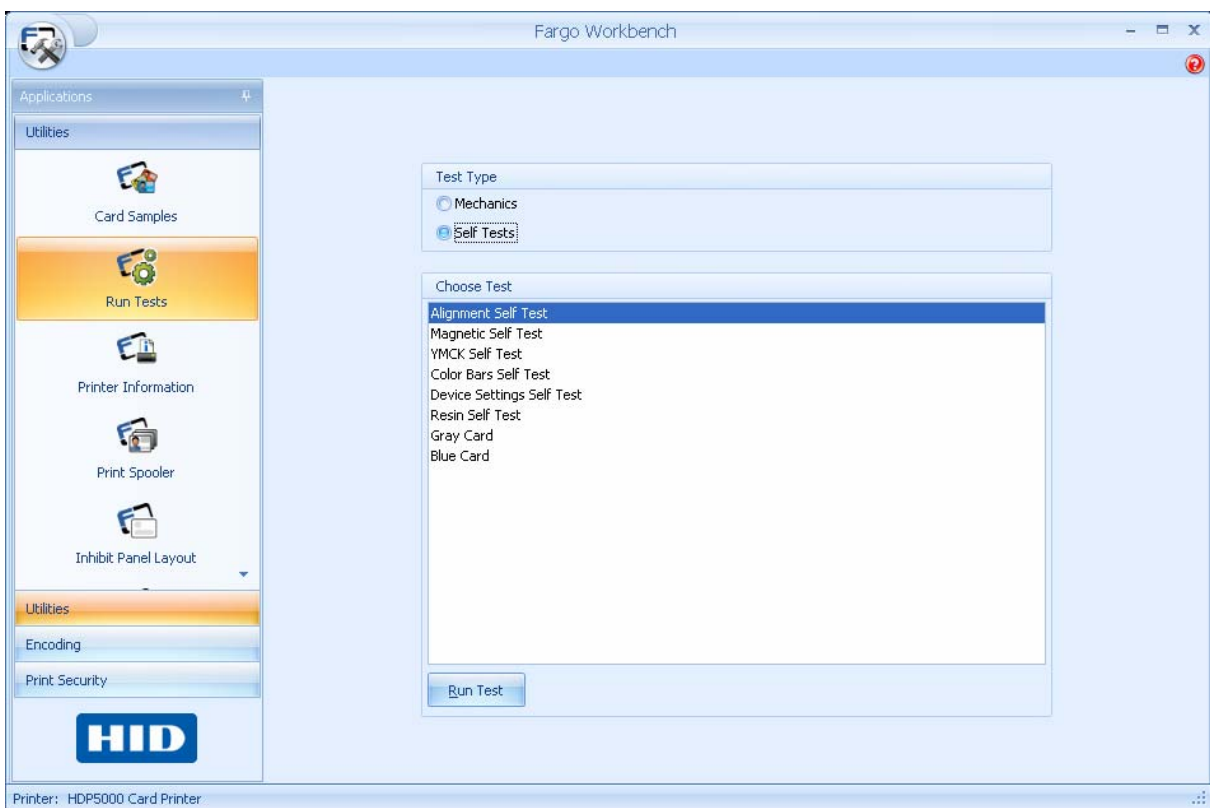

Reviewing the Alignment Self Test Card

Step	Procedure
1	<p>Use this card to determine Image Placement and confirm that the Printer is working properly. (Note: The image consists of sixteen (16) gray scale boxes and alignment arrows. The gray boxes are composed from a composite of YMC color panels.)</p> <p>Adjust the TOF and EOF settings to change image placement.</p>

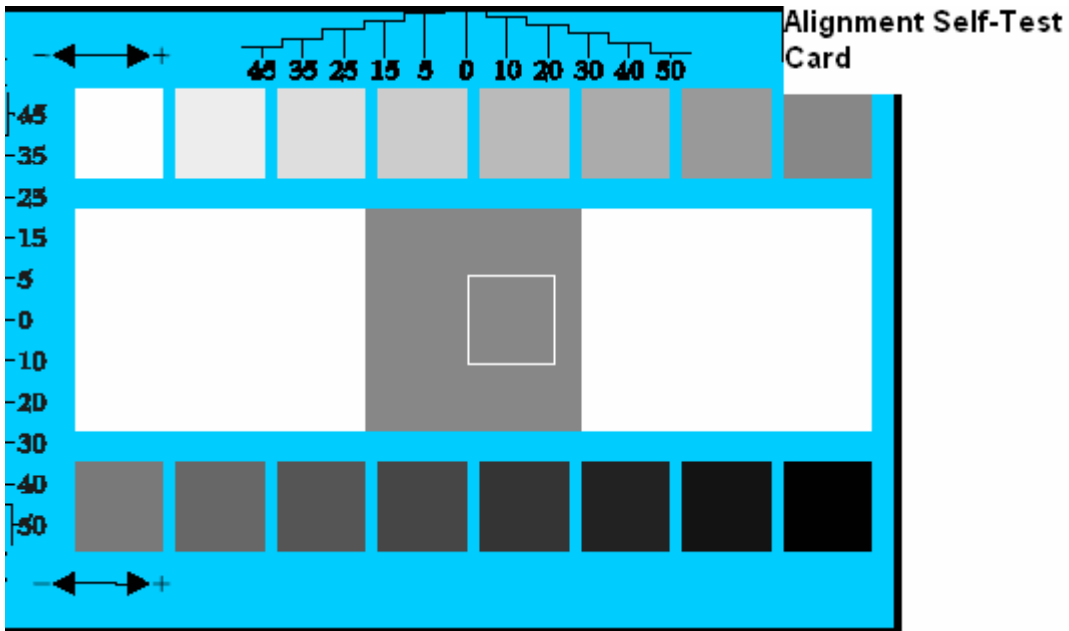

Reviewing the Magnetic Self Test

Step	Procedure
1	This option only applies if a Magnetic Encoding Module is installed in the Printer. (Note: The Printer will feed, encode and eject a card. Be sure to have high coercivity cards installed when running this test.)

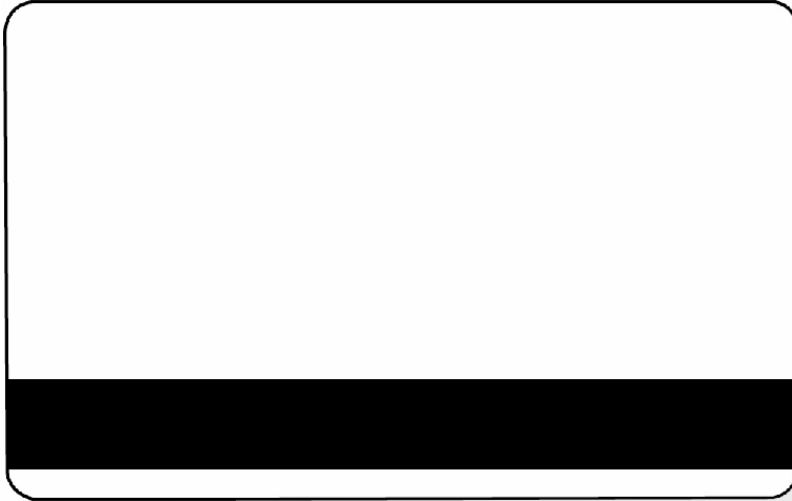

Reviewing the YMCK Self Test

Step	Procedure
1	Use this card to confirm that image colors are properly reproduced. Image consists of sixteen graduated steps of RGB and YMCK. (Note: This print will provide maximum image size, giving complete card Coverage on a CR-80 sized card.)

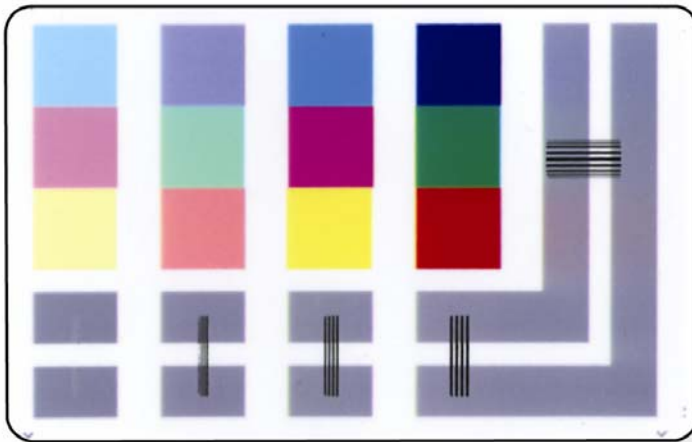

Reviewing the Color Bars Self Test

Step	Procedure
1	Use this card to confirm that image colors are properly reproduced. Image consists of sixteen graduated steps of RGB and YMCK. (Note: This print will provide maximum image size, giving complete card Coverage on a CR-80 sized card.)

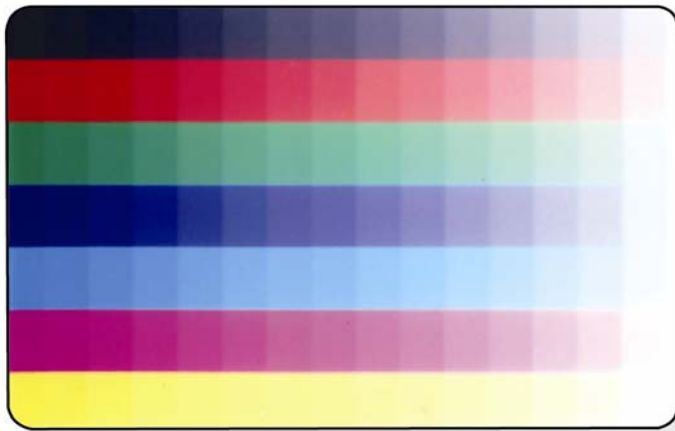

Reviewing the Device Settings Self Test

Step	Procedure
1	<p>Use this card to view the Printer settings and counts for Card Count (CC), Card Cleaning Count (TC) and others.</p> <p>The Card Count is the total number of cards the Printer has produced.</p>

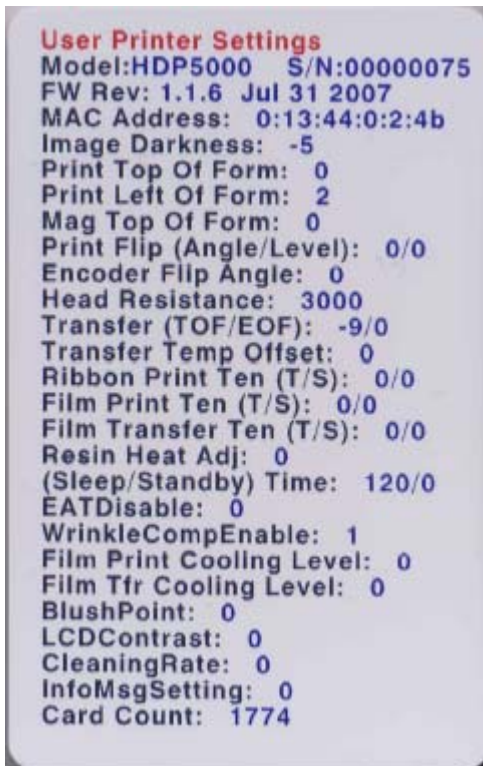

Reviewing the Resin Self Test

Step	Procedure
1	Use this card to determine that the Resin Panel is printing properly.

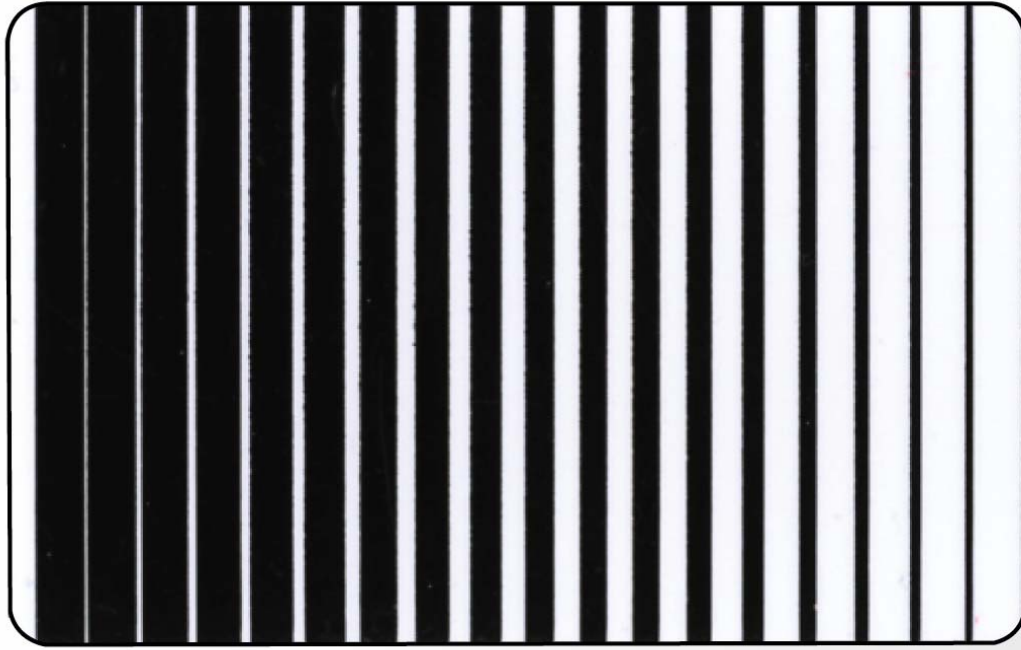

Section 7: Ethernet Option Section

Introduction

The Ethernet option includes the Ethernet port and the internal Printer Server.

- **Printer Management:** The Printer Driver provides bi-directional status information so you can monitor and manage the Printer just as you would any other networked Printer.
- **Compatibility:** The Fargo Ethernet option provides compatibility with TCP/IP and 802.3 Ethernet protocols with an IEEE 802.3 10/100Base-T Ethernet female RJ45 connector.
- **Application:** The Ethernet Option applies to the Fargo HDP5000 High Definition Card Printer/Encoder. With the Ethernet Option properly installed and configured, these Printers are able to print in the same manner as a Printer directly connected to the PC via a USB interface.

Technical Specification - Ethernet Option

Here are the system requirements for Ethernet.



Caution: For safety purposes, Ethernet is not intended for a direct connection outside of the building.

Function	Requirement
Network	An IEEE 802.3 10/100 Base-T Ethernet network is required.
Printer	A Fargo Printer with the Ethernet option installed is required.
Printer Configuration	Since TCP/IP is used for the network communication, the Printer must be configured with an IP address and a subnet mask (before it can be seen on the network). An additional network setting for the Default Gateway can also be configured, which allows communication across the subnets.
Host Computer	A PC running Windows 2000, Windows XP, Windows 2003, Vista (32 bit & 64 bit) (connected to the network) is required.
Host Printer Driver	The host PC must have installed the correct Printer Driver with Ethernet support. (Note: This Driver must be configured for printing to the IP address of the Printer.)

Functional Specification - Ethernet Option

The Fargo Ethernet option includes these features.

Feature	Description
Simultaneous Printing	Provides the ability to simultaneously print from multiple PCs to the network Printer.
Printer Feedback	Provides status information from the network Printer to the PC.
Web Pages	Provides easy Printer configuration with any web browser.
Log Messages	Provides logging of usage and error events via e-mail, UDP or TCP/IP.
Password Security	Provides security with passwords and configurable User permission levels.
Telnet	Provides a Telnet command line interpreter for Printer configuration.
SNMP	Provides an SNMP agent that supports MIB-II.
Upgrades	Provides support for Firmware upgrades over the network.
Troubleshooting	Provides a Ping client for network troubleshooting.
IP Tracer	Provides a utility (IP Tracer) used to find Fargo Printers with Ethernet connection on a local network. (Note: This utility is included on the CD-ROM)

Network Services - Overview

The Ethernet option provides the services described in this section. (**Note:** Other additional services include a Ping client, address assignment and Printer discovery functions.)

Reviewing the Print Server

The Print Server provides printing services in the same manner as a Printer connected directly to a USB interface except that the Printer is connected through the local area network to the client PC. The Print Server must be properly configured in order to provide this printing capability.

- The Print Server is capable of queuing up to eight (8) client PCs while printing. Communications between each PC and the Ethernet-enabled Fargo Printer are implemented over a bi-directional TCP/IP interface.
- All clients are able to send print jobs to the Printer and monitor Printer jobs and errors with the standard Windows printing system using the Fargo Printer Driver installed on their local PC.

In this way, the User knows whether or not a print job has been successful. Also, the User knows what problems have been encountered while processing the print job. Printing using Ethernet works in a manner similar to the USB-connected PC/Printer.

Reviewing the Web Page Server

An HTTP service serves web pages that provide an interface through which to configure and monitor the Printer. (**Note:** Users may also monitor all print jobs that have been sent to the Printer from any client PC.)

Reviewing the Network Management Interface

The Ethernet enabled Printer operates as an SNMP agent to allow central administrators to monitor and configure the network interface and the Printer. (**Note:** A standard host MIB-II is implemented to maximize the utility of the Printer on the network.)

Reviewing the Telnet Server

The Ethernet interface has a command line interpreter. (**Note:** The User can connect to the Printer using a Telnet session on their PC, issue commands to the Printer and receive response from the Printer.)

The Telnet commands are primarily used for network administration, and they will not be used by most Users. (**Note:** These commands will query the state of the Printer and configure various settings for the Printer. These include network settings, logging setting, User names and User passwords.)

Network Management Interface

The SNMP interface is described below.

Interface	Description
SNMP	<ul style="list-style-type: none"> The Ethernet interface is a fully-manageable SNMP agent that supports MIB-II. The Ethernet interface is MIB II compliant, allowing SNMP managers to monitor protocol, network and routing statistics.

Telnet Command Line Interface

Initiating a Telnet Session

This procedure shows how to initiate a Telnet session from a PC in order to access the Telnet services provided by the Printer.

	Description
Initiating a Telnet session	<p>Follow these instructions to issue Telnet commands.</p> <ol style="list-style-type: none"> Identify the IP address of your Printer. (Note: See Switching to the Automatic IP Address Mode.) Initiate a Telnet session from a DOS window on your PC. At the DOS prompt, enter telnet [IP Address] <ul style="list-style-type: none"> Example: C:\>telnet 192.168.11.12 All Telnet responses from the Printer will then be displayed in the Telnet session on the PC. All commands entered will be sent to the Telnet client in the Printer. Enter "help" or "?" to get an on-window list of supported Telnet commands. .

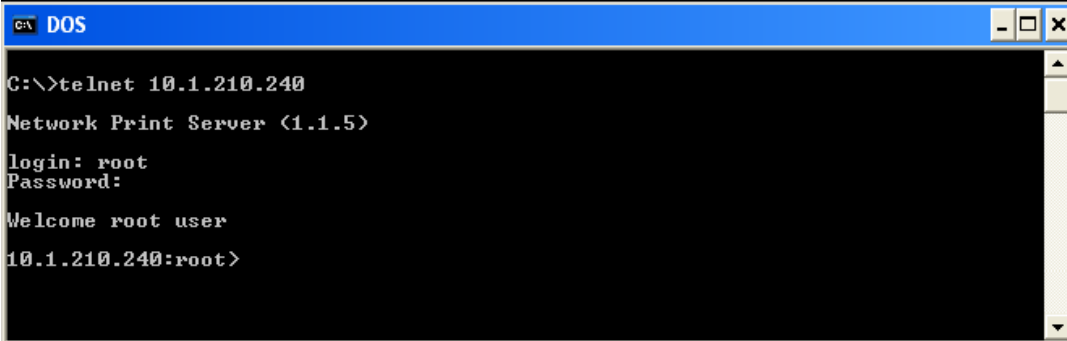

```

C:\>telnet 10.1.210.240
Network Print Server (1.1.5)
login: root
Password:
Welcome root user
10.1.210.240:root>

```

Reviewing the Telnet Command Table

The following table describes available Telnet commands. (**Note:** You can enter partial full-word commands: the Printer will respond with additional help. For example, you can enter “list”, and the Printer will respond with all subcommands to the list command.)

Telnet Command	Command Purpose	Command Format
?	Display help for Telnet commands.	?
help		
reset	Reset the Ethernet interface for the HDP5000 Printer/Encoder.	reset
ping	Send a ping command to another IP address as a test of the Ethernet interface.	ping <IPADDR>

Reviewing the Telnet Command Table

Telnet Command		Command Purpose	Command Format
	diff	Display all differences between current and stored network settings.	list diff
	uptime	Display how long since the interface was last reset.	list uptime
	sysinfo	Display information about the Printer (i.e., model, label, contact, location, Firmware version and date, and serial number).	list sysinfo
	ribbon	Display information about the installed Ribbon in the Printer.	list ribbon
	net	Display information about the current network settings of the Ethernet interface.	list net
stored	net	Display information about the stored network settings of the Ethernet interface.	list stored net
default	net	Display information about the default network settings of the Ethernet interface.	list default net
User		Display information about the defined User names and their type (root or guest privileges).	list User
lpq		Display information about print jobs and their settings.	list lpq
Printer		Display information about the Printer (i.e., model number, Firmware version and serial number).	list Printer
Printer	sm	Display information about the secure mark settings of the Printer.	list Printer sm

Reviewing the Telnet Command Table

Telnet Command		Command Purpose	Command Format	
set	sysinfo	contact	Set the contact string.	set sysinfo label [<STRING>]
		location	Set the location string.	set sysinfo location [<STRING>]
		label	Set the label string.	set sysinfo label [<STRING>]
		from	Set all strings from default or current settings.	set sysinfo from default current
	syslog	name	Change the name of a system log path	set syslog <LOG_NAME> name <NEW_NAME>
		type	Change the type of a system log path. This starts or stops logging on start of jobs or on faults.	set syslog <LOG_NAME> type [[-]job] [[-]pfaul]
		dest	Change the destination of a system log path. This may be set to none, e-mail, udp or tcp.	set syslog <LOG_NAME> dest none email udp tcp
		email	Change the e-mail address for e-mail notification for a system log path. It must specify a valid e-mail address.	set syslog <LOG_NAME> email <EMAIL>
		udp	Specify the IP address of the UPD system logging program.	set syslog <LOG_NAME> udp <IPADDRESS>
		from	Restore system log path settings from the default or current settings.	set syslog from default current

Reviewing the Telnet Command Table

Telnet Command			Command Purpose	Command Format
set	User	add	Add a new User definition. The HDP5000 allows only two (2) User definitions.	set User add <NAME>
		del	Delete a User definition.	set User del <NAME>
		passwd	Define a new password for a User.	set User passwd <NAME> [<PASSWORD>]
		type	Specify a User as root or guest. Only root Users have administrative rights to change network interface settings.	set User type <NAME> root guest
		from	Restore User setting from default or stored settings.	set User from default stored

Reviewing the Telnet Command Table

Telnet Command			Command Purpose	Command Format
store	net	addr	Store a new IP address.	store net addr <ADDRESS>
		mask	Store a new address mask.	store net mask <MASK>
		gateway	Store a new default gateway.	store net gateway <ADDRESS>
		dns	Store a new DNS server address.	store net dns <ADDRESS>
		domain	Store a new DNS domain suffix.	store net domain <STRING>
		opts	Enable or disable automatic address assignment using DHCP. Static (non-automatic) addresses will come from the stored or default settings, depending on the other settings.	To enable automatic address assignment: store net opts dhcp To disable automatic address assignment: store net opts -dhcp
	from	Restore the network settings from either the default settings or the current settings.	store net from default current	
	ifc	mode	Specify the Ethernet interface mode as: automatic, full or half duplex; 10 or 100 mHz. (NOTE: 100 mHz. is not supported by the HDP5000).	store ifc mode auto 10half 10full 100half 100full
from		Set the Ethernet mode settings from the default or current settings.	store ifc from default current	

Reviewing the Telnet Command Table

Telnet Command	Command Purpose	Command Format
save	Save all current settings as the stored settings in the permanent memory.	save
load	Take the settings from the stored memory and make them the current settings.	load
lpstat	Display information about the Printer status. This includes the status and device response. See the Printer web page description.	lpstat
cancel	Cancel a specific print job from the print queue.	cancel 10
quit	Stop the current Telnet session.	quit

Ethernet Web Pages – Standard Procedures

Reviewing Web page security

You can use the web pages from your Fargo Ethernet-connected Printer to view several attributes about the Printer. Users must have administrative rights, and they must enter the correct password to alter settings of the Printer.

Logging In

When a User attempts to change any setting, they are asked for a User name and password. (**Note:** The Guest Users can only view settings.)

Step	Procedure
1	Enter the correct User name: <ul style="list-style-type: none"> • The default administrative User name is root. • The default non-administrative User name is guest. • Non-administrative Users can only view settings.
2	Enter the correct password: <ul style="list-style-type: none"> • The default password is an empty string. If the password has not been changed, leave the field blank. • See Password page procedure for changing passwords.
3	Press Enter or click on the OK button.
4	If the name and password is not accepted, another login prompt will appear on screen. (Note: Repeat this procedure with the correct User name and password.)

Logging In



Accessing the Home page

Step	Procedure
1	Open a window for your network browser application on your local PC.
2	Find the IP address of the Printer. (Note: See Accessing the HDP5000 IP Address as needed to get this from the LCD of the Printer.)
3	Enter the IP address of the Printer you want to access into the address bar of the browser. (Note: The IP address will change for your printer installation.)
4	Press Enter or click on GO .
5	View the Home page. The Home Page displays general information about the Printer. See the next page.

Display A – See Procedural Steps 2 and 3 (above)

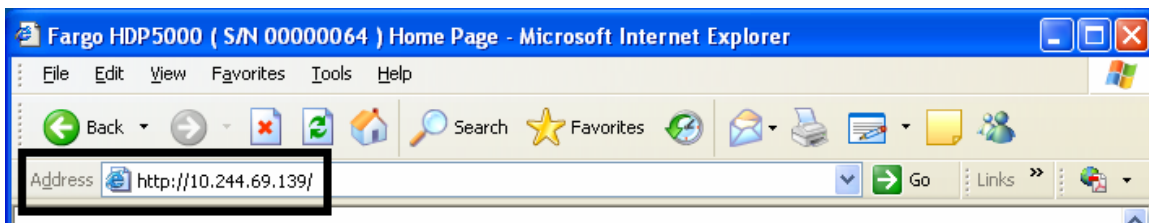

Reviewing the Home Page

This section provides a display of the HDP5000 Home Page.

Home | [Network](#) | [Print Path](#) | [Status](#) | [System Log](#) | [Administration](#) | [Help](#)

FARGO®

HDP5000 Home

Contact [Fargo Electronics Inc.](#) for product information, technical support, and downloads.

Printer Information:

Label:	FRGO000240
Location:	
Contact:	
Serial Number:	00000064
Printer Firmware Version:	1.1.6
Boot Loader Firmware Version:	00.00.12
Hardware Address:	00:13:44:00:02:40

Reviewing the Home Page Categories and Fields (table)

You can view these categories and fields in the following table.

Category	Field	Purpose
Fixed for Printer	Serial Number	Displays the unique fixed serial number of the Printer.
	Hardware Address	Displays the unique fixed hardware address (MAC) of the Printer, which is the unique Ethernet device identifier.
Set by User (May be configured via Telnet or from the Administration web page.)	Label	Indicates the label that the User assigns to the Printer. This label is reported to the DHCP server as the Host Name (that may be used by the DNS server to resolve the IP address of the Printer). If left blank, the Printer will use a unique label based on the MAC address of the Printer.
	Location	Indicates the location string that the User assigns to the Printer.
	Contact	Indicates the contact person string that the User assigns to the Printer.
Set by Firmware	Printer Firmware Version	Displays the current Firmware version.
	Boot Loader Firmware Version (HDP5000 only)	Displays the current boot loader Firmware version.

Configuring the Network Settings

The procedures needed to configure the network settings are presented in this section.

Accessing the Network Settings page

The Network page displays the current network settings and allows the User to change the settings.

Step	Procedure
1	Select the Network link from any web page of the Printer.

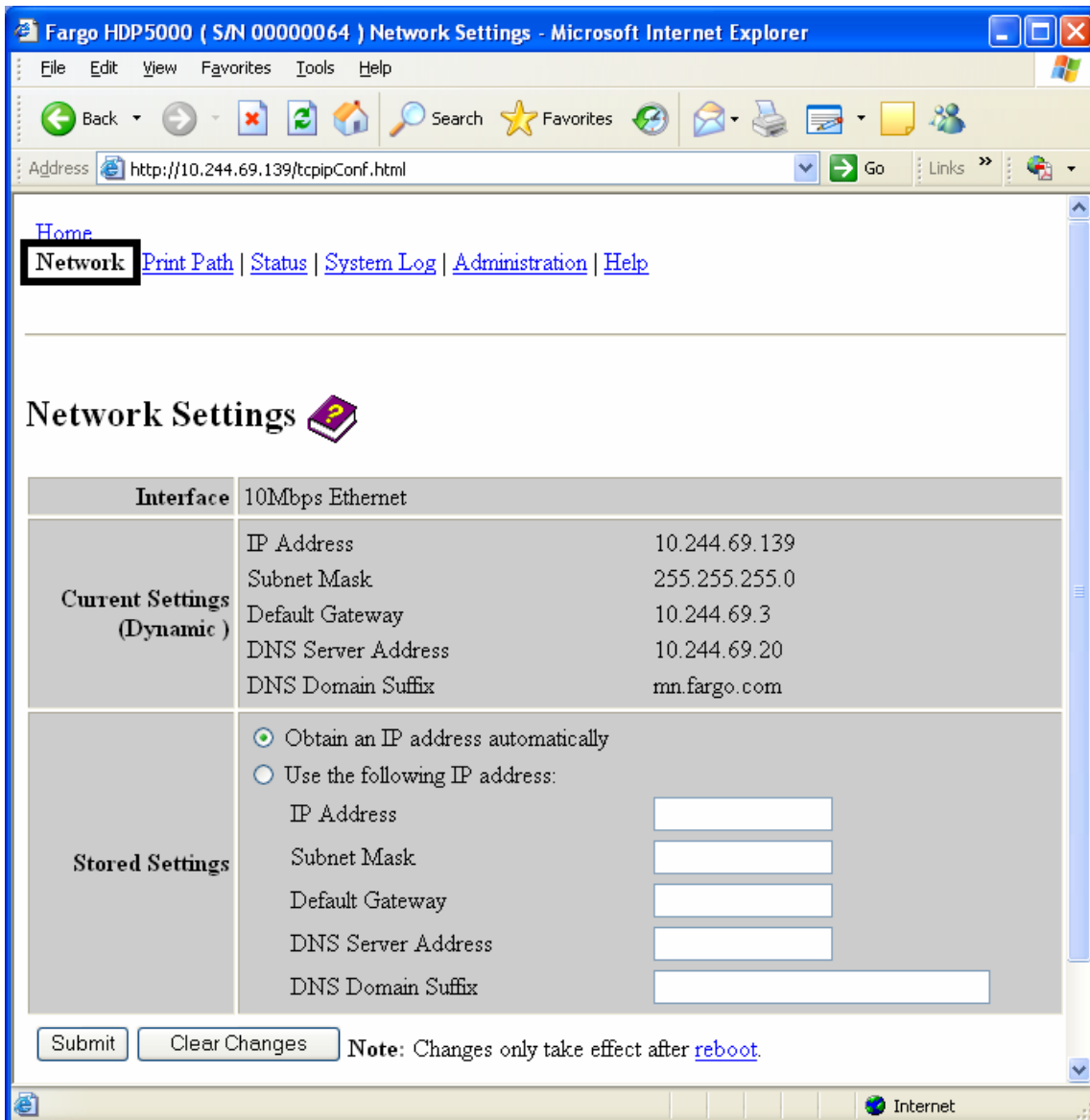

Reviewing the Interface

The Interface display indicates the network speed supported by the Printer.

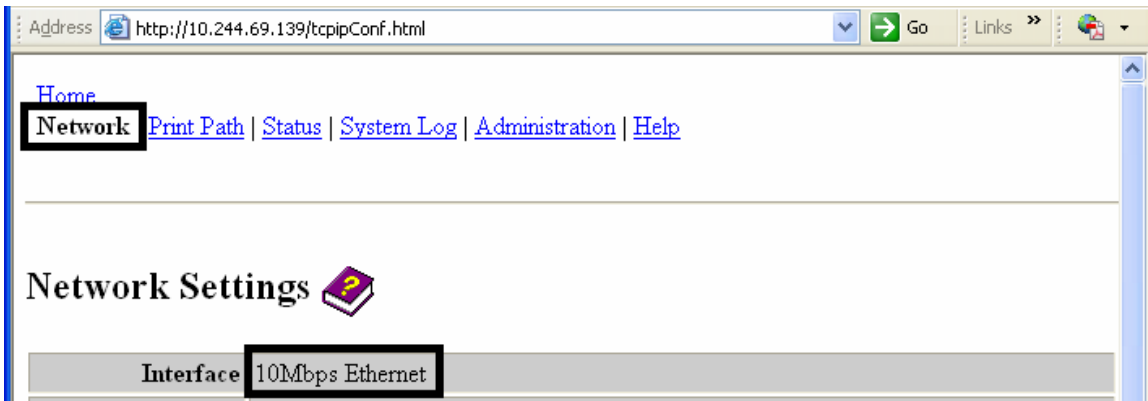

Reviewing the Current Settings

The Current Settings page section displays the current active network settings for the Printer.

- These are also labeled as “Dynamic” if they were provided by DHCP or “Static” if they came from the Stored Settings.
- The current settings will be “Dynamic” only if **Obtain an IP address automatically** was selected when the Printer was restarted last.

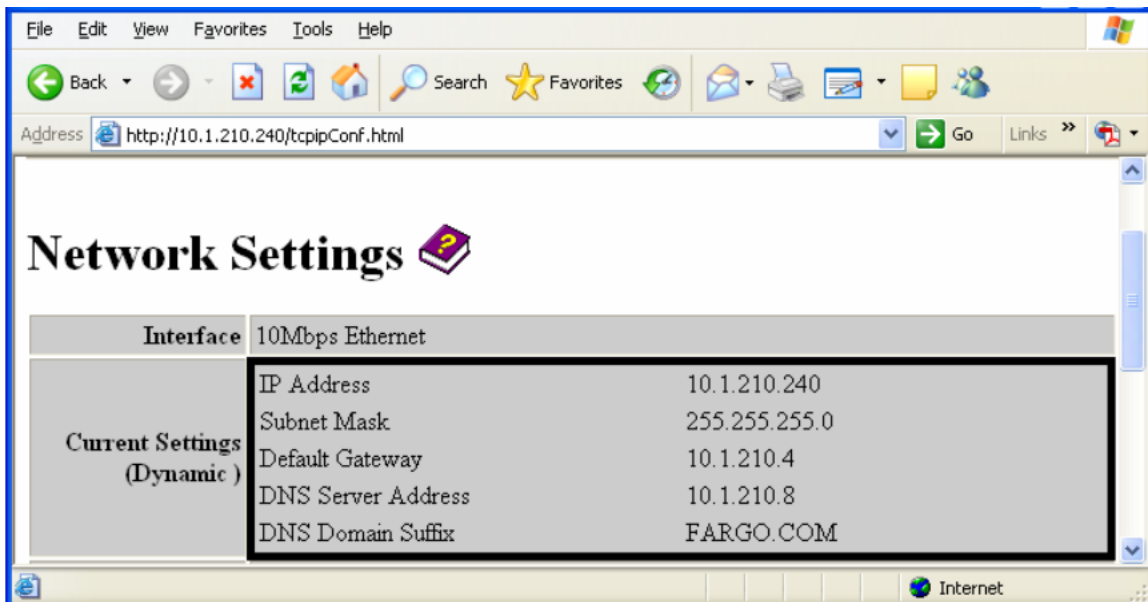

Switching to the Automatic IP Address Mode

Step	Procedure
1	Select the Network link from any web page of the Printer.
2	Select the Obtain an IP address automatically radio button to enable the DHCP/BOOTP, which automatically assigns the network settings. Even with this button selected, the User can enter Stored Settings, and the Stored Settings will remain in memory. See below. (Note: This is the default method.)
3	Click on the Submit button to save this setting.
4	Login as a root User if you are so prompted. (Note: Any change of setting will only be accepted after you have successfully logged in.)
5	Reboot the Printer to affect this change.

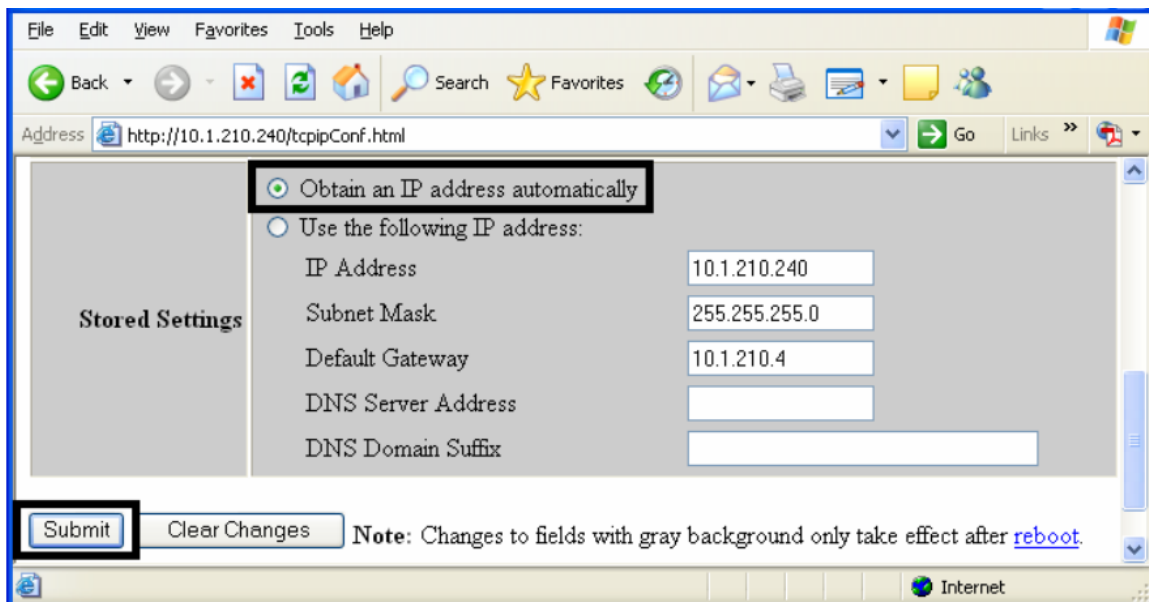

Changing to the Static IP Address Mode

Step	Procedure
1	Select the Network link from any web page of the Printer.
2	Select the Use the following IP address radio button, which prepares the Printer to use network settings (that the User has manually set). These manual settings will then be used the next time the Printer is rebooted.
3	Enter the network settings which are required for Ethernet communications from within the same subnet. With only these entries the User will be unable to print from a subnet other than the subnet on which the Printer is connected. These required settings are the following: <ul style="list-style-type: none"> • IP Address • Subnet Mask
4	Enter the optional network settings for Ethernet communications across a router from other subnets, as follows: <ul style="list-style-type: none"> • Default Gateway
5	Enter the optional network settings for DNS. These are the following: <ul style="list-style-type: none"> • DNS Server Address • DNS Domain Suffix
6	Select the Submit button to save these changes to stored settings in the memory of the Printer. (Note: These settings will not be lost if the power is removed from the Printer.)

Changing to the Static IP Address Mode

Step	Procedure
7	Login as a root User if you are so prompted. (Note: Any change of setting will only be accepted after you have successfully logged in.)
8	Reboot the Printer to effect this change. See the Reviewing Web page security procedure.

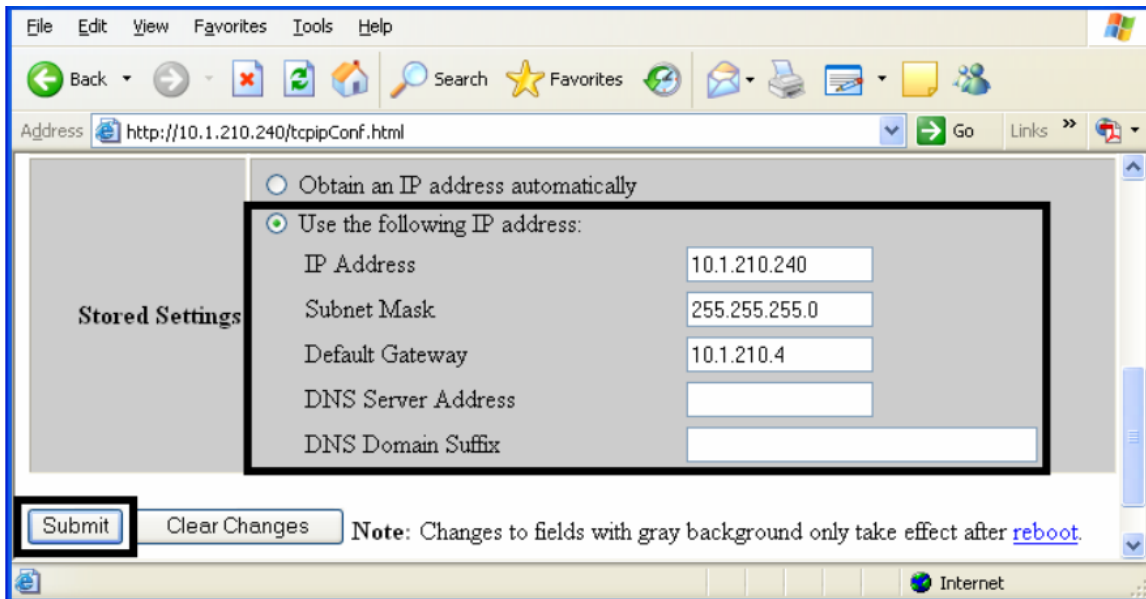

Using the Clear Changes button

Step	Procedure
1	Click on the Clear Changes button to delete the information in the textboxes in Stored Settings area. See the lower left corner of this display.

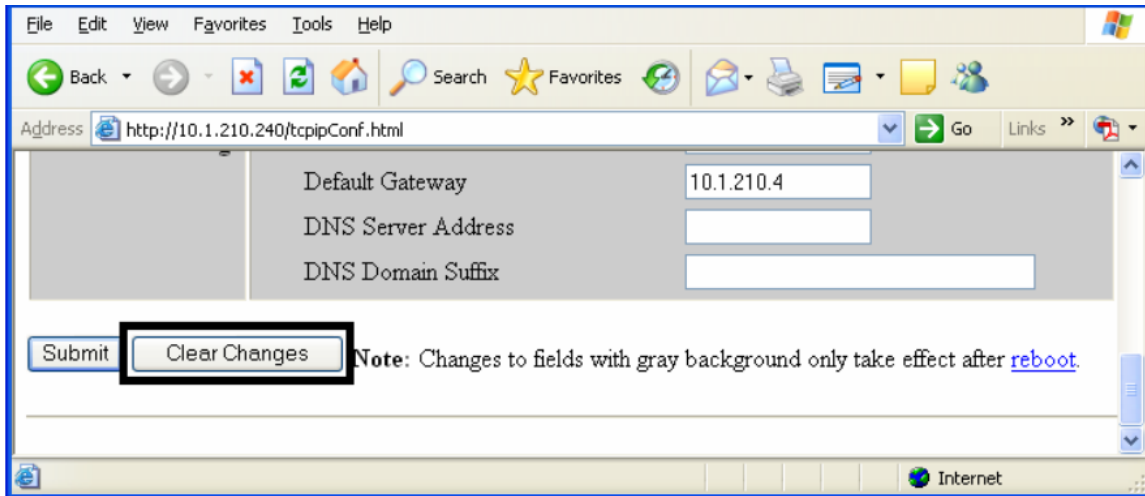

Using the Media Information page

This page displays Media information about the Ribbon and Film (currently installed in the Printer).

Step	Procedure
1	Select the Status link from any web page of the Printer.
2	Select the Media page link.
3	View currently-installed Ribbon information pertaining to the following: <ul style="list-style-type: none"> • Part Number • SecureMark Part Number • Percent Remaining • Ribbon Type

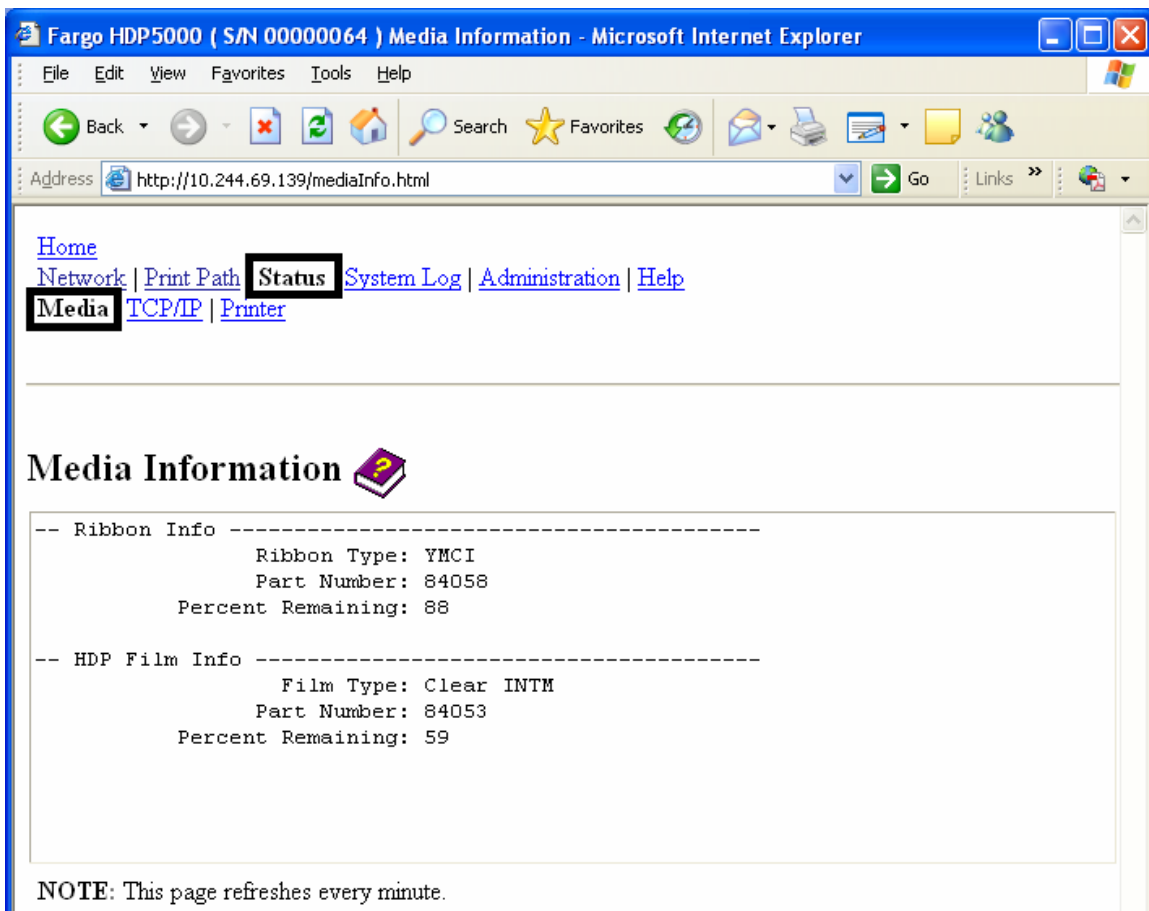

Fargo HDP5000 (S/N 0000064) Media Information - Microsoft Internet Explorer

File Edit View Favorites Tools Help

Back Forward Stop Refresh Home Search Favorites Mail Print Mail Stop Links

Address http://10.244.69.139/mediaInfo.html Go Links

[Home](#) | [Network](#) | [Print Path](#) | [Status](#) | [System Log](#) | [Administration](#) | [Help](#)
[Media](#) | [TCP/IP](#) | [Printer](#)

Media Information

```

-- Ribbon Info -----
      Ribbon Type: YMCI
      Part Number: 84058
      Percent Remaining: 88

-- HDP Film Info -----
      Film Type: Clear INTM
      Part Number: 84053
      Percent Remaining: 59
  
```

NOTE: This page refreshes every minute.

Using the TCP/IP page

The TCP/IP page displays the TCP/IP Status of each Printer connection, which are not configurable. See the next two pages for displays.

Step	Procedure
1	Select the Status link from any web page of the Printer.
2	Select the TCP/IP page link.
3	View information on all current network connections in the TCP connections area.

Using the TCP/IP page

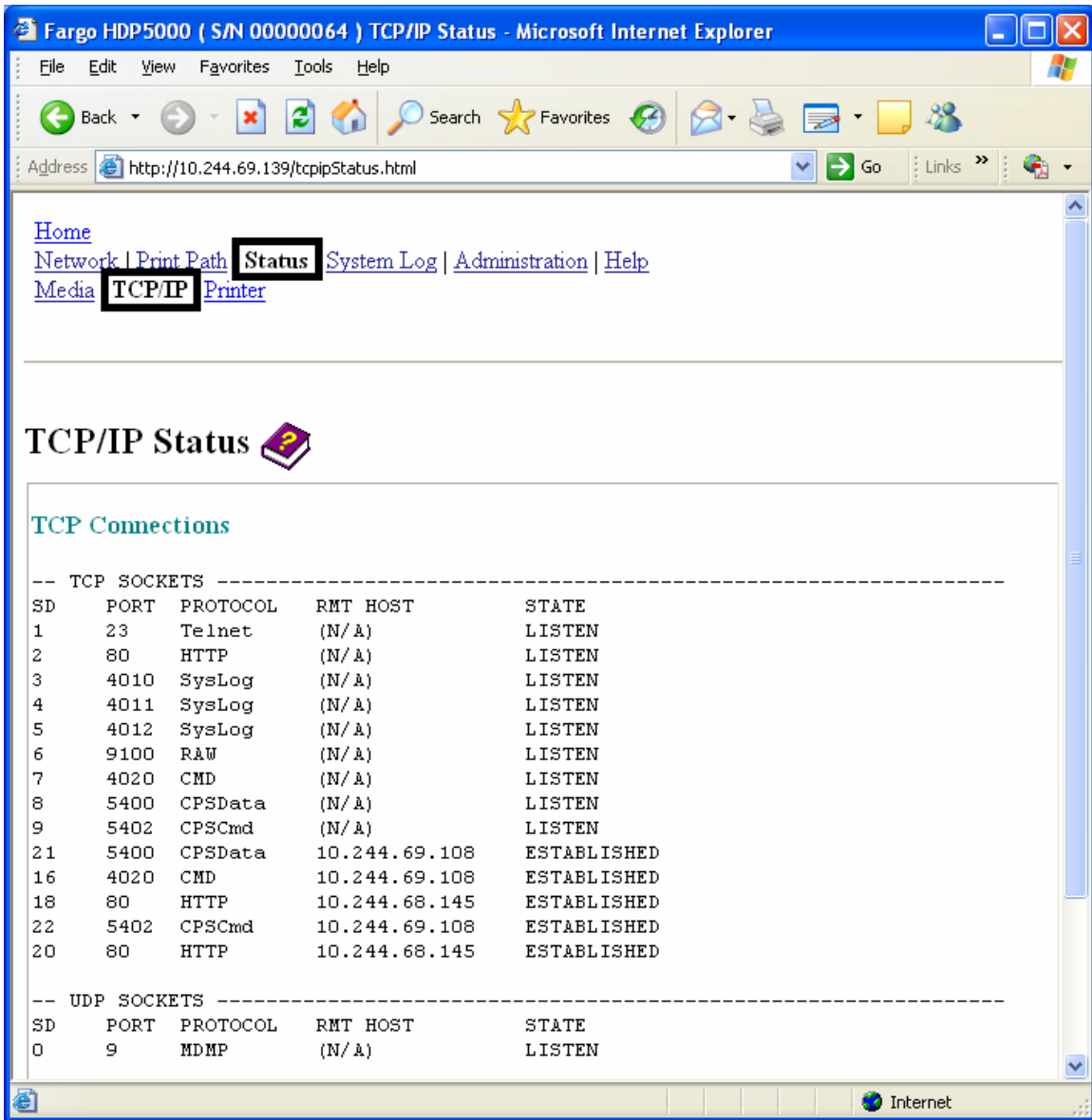

Using the Printer page

You can use the Printer page to review current information about the Printer device settings and print jobs. Device settings include the following:

- The **status** which displays information about the current print job.
- The **device** which displays information about the Printer.

The fields are described below. See the next page to view the entire Printer page.

Field	Status	Description
status	Idle	Indicates that no print job is active.
	Printing	Indicates that the job is being sent to the Printer.
	printing – waiting	Indicates that the communication is being slowed by print operations.
	printing – blocked	Indicates that the communication has been stopped by some condition.
	canceled	Indicates that the current job was canceled and is being rerouted .
device	online	Indicates it is ready to print.
	offline	Indicates that the Cover is open or the Printer is not ready to print.
	Printer – error	Indicates that an error is detected.
	Busy	Indicates that printing is in progress.
Print Jobs		This is a display of the current print jobs that have been sent to the Printer. (Note: The current job that is being received by the interface is displayed as the active job.) Cancel a specific print job by selecting the appropriate Cancel button, which appears when a print job is queued.

Using the Printer page

See the previous page for descriptions of the fields.

[Home](#)
[Network](#) | [Print Path](#) | [Status](#) | [System Log](#) | [Administration](#) | [Help](#)
[Media](#) | [TCP/IP](#) | [Printer](#)

Printer

Device Settings

Status	ending job
Device	online

Print Jobs

Active:

	job: 33529
	type: CPS

Queued:

NOTE: This page refreshes every minute.

Using the System Log page

The System Log page displays the current system log settings and allows the User to change the settings. (**Note:** These settings configure how system logging occurs. There are two logs.)

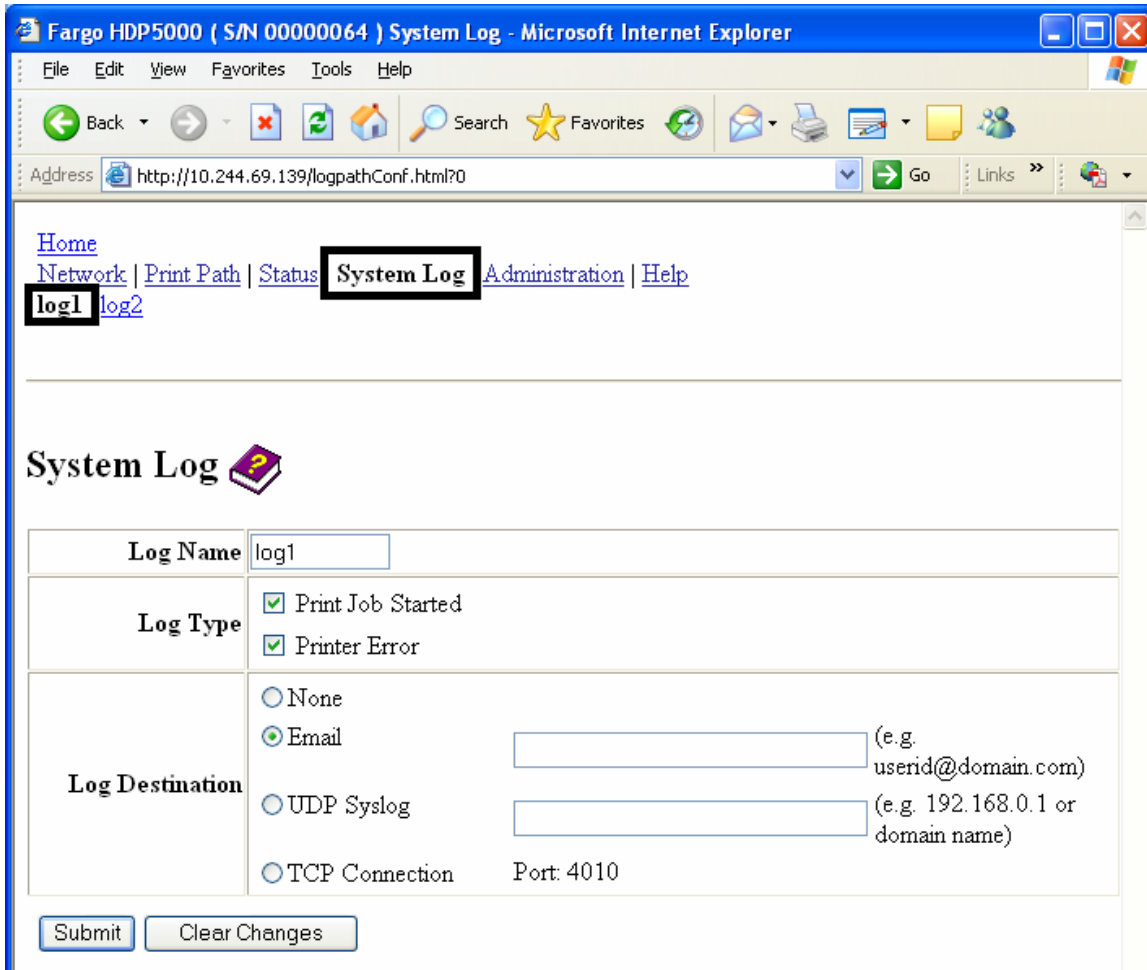

Changing the Log Name

By default the names are log1 and log2. However, you can rename them from this page.
(**Note:** This also updates the link to the corresponding web page.)

Step	Procedure
1	Select the System Log link.
2	Select the link for the log name you want to view or configure (the default choices are log1 or log2). See the previous page.
3	Enter a new log name in textbox.
4	Click on the Submit button to save this change.
5	Login as a root User if you are so prompted. (Note: Any change of setting will only be accepted after you have successfully logged in.)

Fargo HDP5000 (S/N 0000064) System Log - Microsoft Internet Explorer

File Edit View Favorites Tools Help

Back Forward Stop Home Search Favorites Refresh Mail Print Print Preview Links

Address http://10.244.69.139/logpathConf.html?0 Go Links

[Home](#) | [Network](#) | [Print Path](#) | [Status](#) | **System Log** | [Administration](#) | [Help](#)

[log1](#) | [log2](#)

System Log

Log Name	<input type="text" value="log1"/>
Log Type	<input checked="" type="checkbox"/> Print Job Started <input checked="" type="checkbox"/> Printer Error
Log Destination	<input type="radio"/> None <input checked="" type="radio"/> Email <input type="text"/> (e.g. userid@domain.com) <input type="radio"/> UDP Syslog <input type="text"/> (e.g. 192.168.0.1 or domain name) <input type="radio"/> TCP Connection Port: 4010

Selecting the Log Type

Step	Procedure
1	Select the System Log link. See the next page.
2	Select the link for the log name you want to view or configure (the default choices are log1 or log2).
3	Select the Print Job Started checkbox to generate the log entries for each Print Job Started.
4	Select the Printer Error checkbox to generate the log entries for each Printer Error.
5	Select the Submit button.
6	Login as a root User if you are so prompted. (Note: Any change of setting will only be accepted after you have successfully logged in.)

File Edit View Favorites Tools Help

Back Forward Stop Home Search Favorites Refresh Mail Print Mailbox Links

Address <http://10.244.69.139/logpathConf.html?0> Go Links

[Home](#) | [Network](#) | [Print Path](#) | [Status](#) | **System Log** | [Administration](#) | [Help](#)

log1 [log2](#)

System Log

Log Name

Log Type

- Print Job Started
- Printer Error

Log Destination

- None
- Email (e.g. userid@domain.com)
- UDP Syslog (e.g. 192.168.0.1 or domain name)
- TCP Connection Port: 4010

Selecting the Log Destination

Specify one destination for the log.

Step	Procedure – No event logging.
1	Select the System Log link.
2	Select the link for the log name you want to view or configure (the default choices are log1 or log2).
3	Select the None radio button when no log is required. (Note: This is the default.)
4	Select Submit .
5	Login as a root User if you are so prompted. Any change of setting will only be accepted after you have successfully logged in.

The screenshot shows a web browser window displaying the 'System Log' configuration page. The address bar shows 'http://10.244.69.139/logpathConf.html?0'. The page has a navigation menu with links for Home, Network, Print Path, Status, System Log, Administration, and Help. Below the navigation, there are links for log1 and log2. The main content area is titled 'System Log' and contains a form with the following fields:

- Log Name:** A text input field containing 'log1'.
- Log Type:** A list of checkboxes: 'Print Job Started' (checked), 'Printer Error' (checked).
- Log Destination:** A list of radio buttons: 'None' (selected), 'Email' (with an adjacent text input field for an email address), 'UDP Syslog' (with an adjacent text input field for an IP address), and 'TCP Connection' (with an adjacent text input field for a port number, currently set to 4010).

At the bottom of the form, there are two buttons: 'Submit' and 'Clear Changes'. The 'Submit' button is highlighted with a black box.

Setting up Email Event logging

Follow this procedure to enable logging using email notification:

Step	Procedure – Specify email logging.
1	Select the System Log link.
2	Select the link for the log name you want to view or configure (the default choices are log1 or log2).
3	Select the Email radio button to choose email log notification.
4	Enter a valid e-mail address in the associated textbox.
5	Select Submit .
6	Login as a root User if you are so prompted. (Note: Any change of setting will only be accepted after you have successfully logged in.)

File Edit View Favorites Tools Help

Back Forward Stop Refresh Home Search Favorites Recycle Bin Mail Print Mailbox Mailbox Mailbox Mailbox Mailbox

Address <http://10.244.69.139/logpathConf.html?0> Go Links

[Home](#) | [Network](#) | [Print Path](#) | [Status](#) | **System Log** | [Administration](#) | [Help](#)

log1 | [log2](#)

System Log

Log Name	<input type="text" value="log1"/>
Log Type	<input checked="" type="checkbox"/> Print Job Started <input checked="" type="checkbox"/> Printer Error
Log Destination	<input checked="" type="radio"/> None <input checked="" type="radio"/> Email <input type="text" value=""/> (e.g. userid@domain.com) <input type="radio"/> UDP Syslog <input type="text" value=""/> (e.g. 192.168.0.1 or domain name) <input type="radio"/> TCP Connection Port: 4010

Specifying UDP Event logging

Follow this procedure to enable logging to a UDP Syslog program.

Step	Procedure
1	Select the System Log link. <ul style="list-style-type: none">• The messages will be sent via UDP packets to the Syslog port (514) of the specified host.• It is up to the host program to listen to these messages for processing.• A syslog host program is necessary to use this method, such as, Kiwi Syslog Daemon or WinSysLog.
2	Select the link for the log name you want to view or configure (the default choices are log1 or log2).
3	Select the UDP Syslog radio button.
4	Enter a valid IP address or domain name.
5	Select Submit .
6	Login as a root User if you are so prompted. (Note: Any change of setting will only be accepted after you have successfully logged in.)

Specifying UDP Event logging

The screenshot shows a web browser window with the address bar displaying `http://10.244.69.139/logpathConf.html?0`. The browser's menu bar includes File, Edit, View, Favorites, Tools, and Help. The address bar contains a 'Go' button and a 'Links' dropdown. The page content includes a navigation menu with links for Home, Network, Print Path, Status, System Log (highlighted), Administration, and Help. Below the navigation menu, there are links for log1 and log2. The main heading is 'System Log' with a question mark icon. The configuration form has three sections: 'Log Name' with a text input field containing 'log1'; 'Log Type' with two checked checkboxes for 'Print Job Started' and 'Printer Error'; and 'Log Destination' with three radio button options: 'None', 'Email' (with an adjacent text input field for an email address), and 'UDP Syslog' (highlighted). Below the 'UDP Syslog' option is another text input field for a destination IP or domain name, with a note '(e.g. 192.168.0.1 or domain name)'. At the bottom of the form, there are two buttons: 'Submit' (highlighted) and 'Clear Changes'.

Specifying TCP Event logging

Follow this procedure to send logging messages to a pre-existing IP connection made on the TCP port.

Step	Procedure
1	Select the System Log link.
2	Select the link for the log name you want to view or configure (the default choices are log1 or log2).
3	Select the TCP Connection radio button.
4	Select Submit .
5	Login as a root User if you are so prompted. Any change of setting will only be accepted after you have successfully logged in.

The screenshot shows a web browser window with the address bar displaying `http://10.244.69.139/logpathConf.html?0`. The page content includes a navigation menu with links for [Home](#), [Network](#), [Print Path](#), [Status](#), [System Log](#) (highlighted with a red box), [Administration](#), and [Help](#). Below the menu, there are links for [log1](#) and [log2](#). The main heading is "System Log" with a help icon. The configuration form has the following fields:

- Log Name:**
- Log Type:**
 - Print Job Started
 - Printer Error
- Log Destination:**
 - None
 - Email (e.g. userid@domain.com)
 - UDP Syslog (e.g. 192.168.0.1 or domain name)
 - TCP Connection Port: 4010 (highlighted with a red box)

At the bottom of the form, there are two buttons: **Submit** (highlighted with a red box) and **Clear Changes**.

Specifying TCP Event logging

Step	Procedure
6	<p>Use a host program such as Telnet to receive these TCP logging messages (Note: Other programs such as HyperTerminal are also used to monitor TCP connections). See below.</p> <ul style="list-style-type: none"><li data-bbox="386 472 1388 535">• Telnet Client: You can use a Telnet client connected to the TCP port (log1 = 4010, log2 = 4011) rather than the default Telnet port (23).<li data-bbox="386 556 1388 682">• Telnet Session: If there is a Printer at IP address 192.37.23.155 (and you have configured log1 for TCP logging), then you could initiate a Telnet session from a DOS window of a PC by entering Telnet 192.37.23.155 4010.<li data-bbox="386 703 1388 808">• Log Messages: All system log messages would then be displayed in that Telnet session window. (Note: This is a one way connection for logging only. Any input to the Printer on this connection is ignored.)

Using the Administration pages

The purpose of the Administration pages is to allow the User to upgrade, reboot, modify passwords and enter User-specified system information strings.

Using the System Information page

The System Information page displays the current system information and allows the User to change the system information (which appears on the Home page). See the [Using the Home page](#) for definitions.

Step	Procedure
1	Select the Administration link.
2	Select the link for the System web page.
3	To change an attribute, type the new entry in one of these boxes: <ul style="list-style-type: none">• Label textbox• Location textbox• Contact textbox
4	Select the Submit button.
5	Login as a root User if you are so prompted. Any change of setting will only be accepted after you have successfully logged in.

Using the System Information page

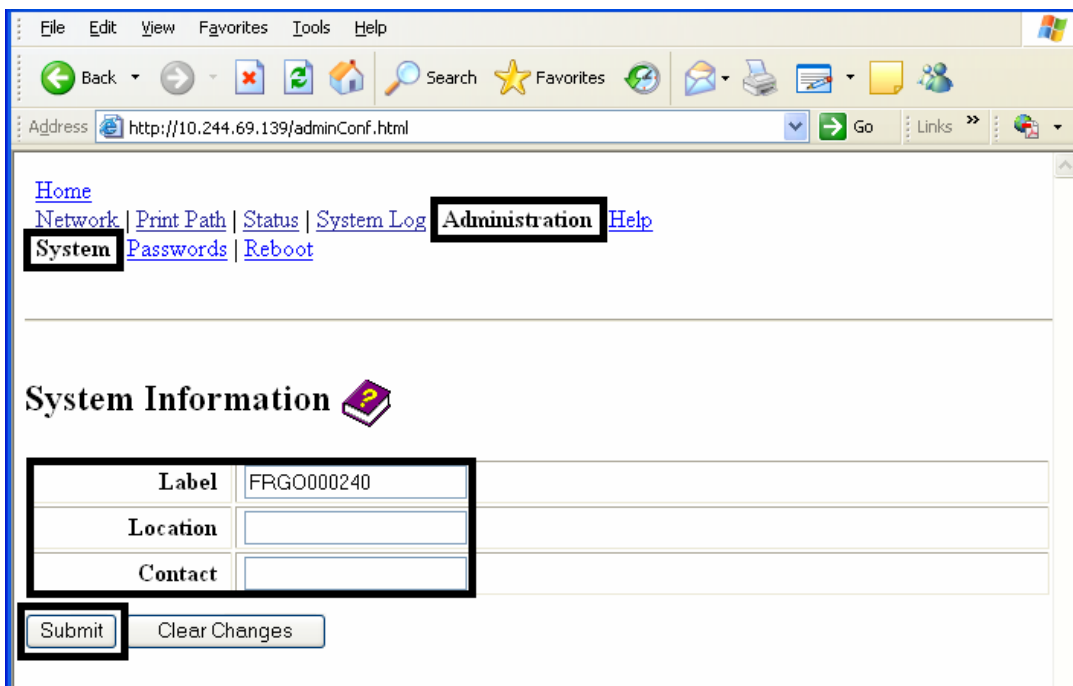

Changing the Root Password

The Passwords page allows the User to change the passwords needed to login as a User. Changes to all settings require a login. (**Note:** However, these changes are only protected by password after the password has been set. Users can only be added or removed using Telnet commands.)

Step	Procedure
1	Select the Administration link.
2	Select the Passwords link to get to the Password web page.
3	Enter the current password in the Root Password Old textbox or leave it blank if no password has been previously set.
4	Enter the new password in the Root Password New textbox or leave it blank if you want to remove the old password.
5	Re-enter the new password in the Root Password Confirm textbox or leave it blank if you want to remove the old password.
6	Select the Submit button.
7	Log in as a root User (using the password) if you are so prompted. (Note: Any change of setting will only be accepted after you have successfully logged in.)

Using the Reboot pages

Rebooting the HDP5000 restarts the complete Printer, which includes the Print Server.

Rebooting the Printer

The Reboot page allows the HDP5000 User to reboot or reset the Printer and/or enter the upgrade mode.

Step	Procedure
1	Select the Administration link.
2	Log in as a root User (using the password) if you are so prompted. (Note: Any change of setting will only be accepted after you have successfully logged in.)
3	Select the Reboot link.
4	Select the Reboot button.
5	Click Yes when prompted.
6	Wait for the Printer to reboot and display the home page. See the Reviewing the HDP5000 Home Page display.

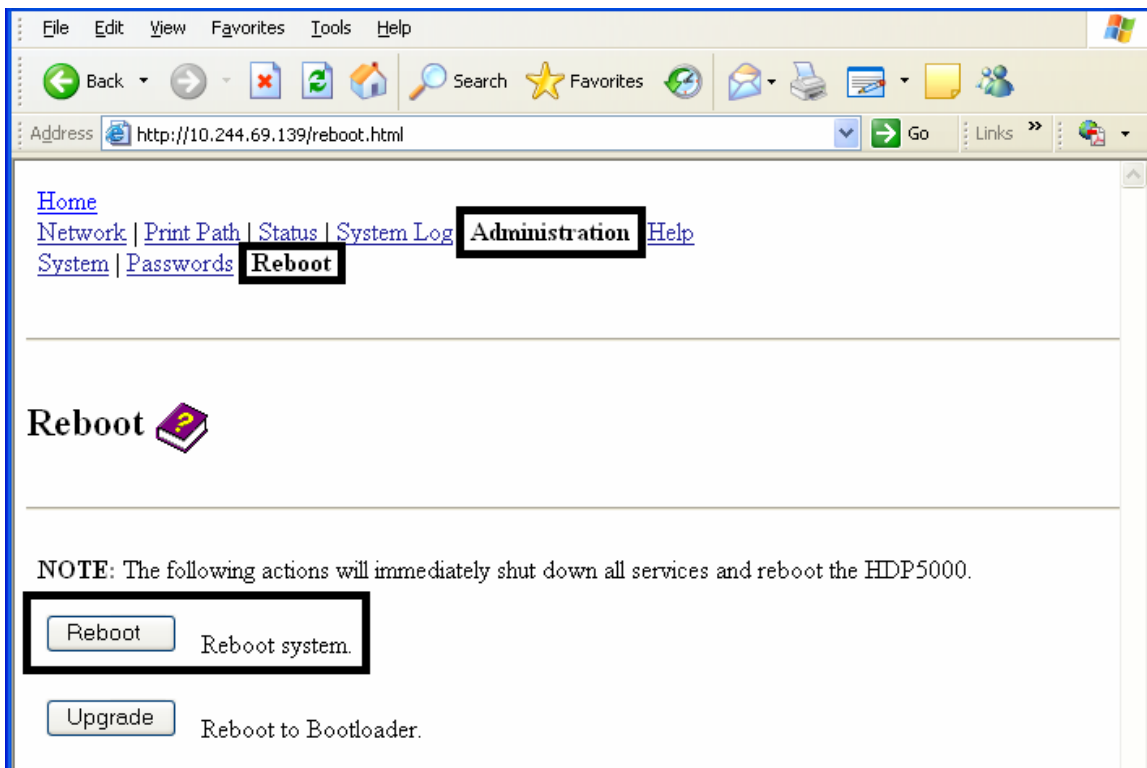

Upgrading the Main Firmware

The Upgrade page allows the User to upload new Firmware to the Printer. For the HDP5000 Printer/Encoder, this Upgrade page provides for upgrading the main Printer Firmware which includes the Print Server Firmware.

It is only available to the HDP5000 after the Printer has been rebooted into the upgrade mode.

Step	Procedure
1	Select the Administration link.
2	Go to Step 7 if the Upgrade link is shown.
3	Select the Reboot link if the Upgrade link is not shown.

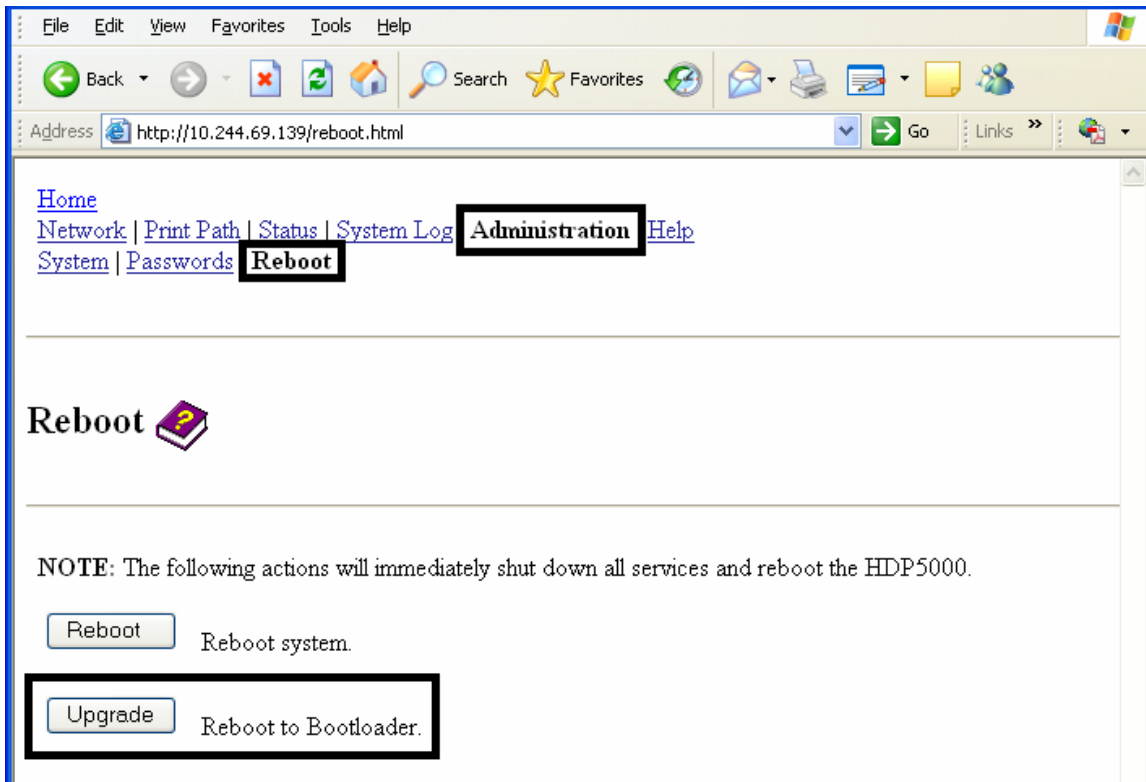

Upgrading the Main Firmware

Step	Procedure
4	Select the Upgrade button to get Printer into the upgrade mode.
5	Select the Yes button and wait for reboot, as shown below in Displays A and B.

Display A – Rebooting into the Upgrade Mode

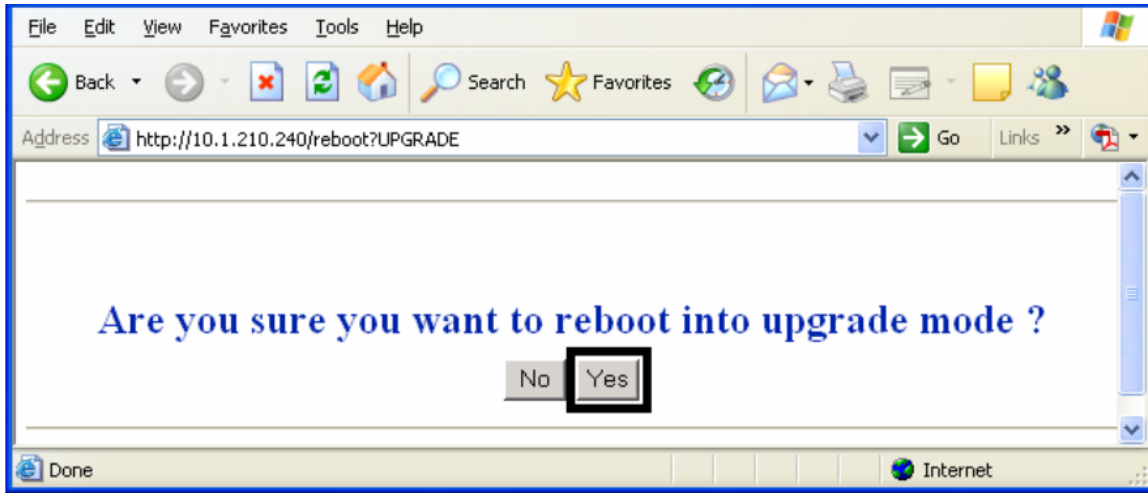

Display B – Waiting for the Upgrade Mode

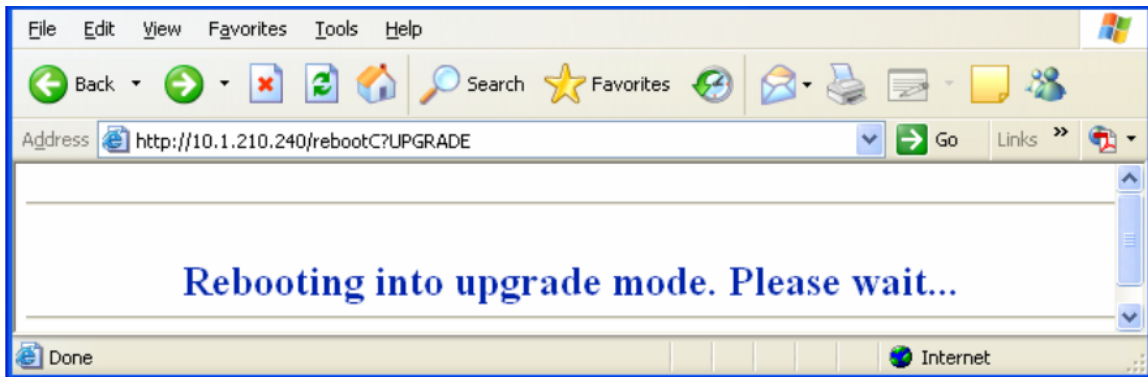

Upgrading the Main Firmware

Step	Procedure
6	Select Administration when the Home page appears. See Display A below.
7	Select Upgrade to get to the upgrade page. See Display B below.

Display A – Selecting Administration

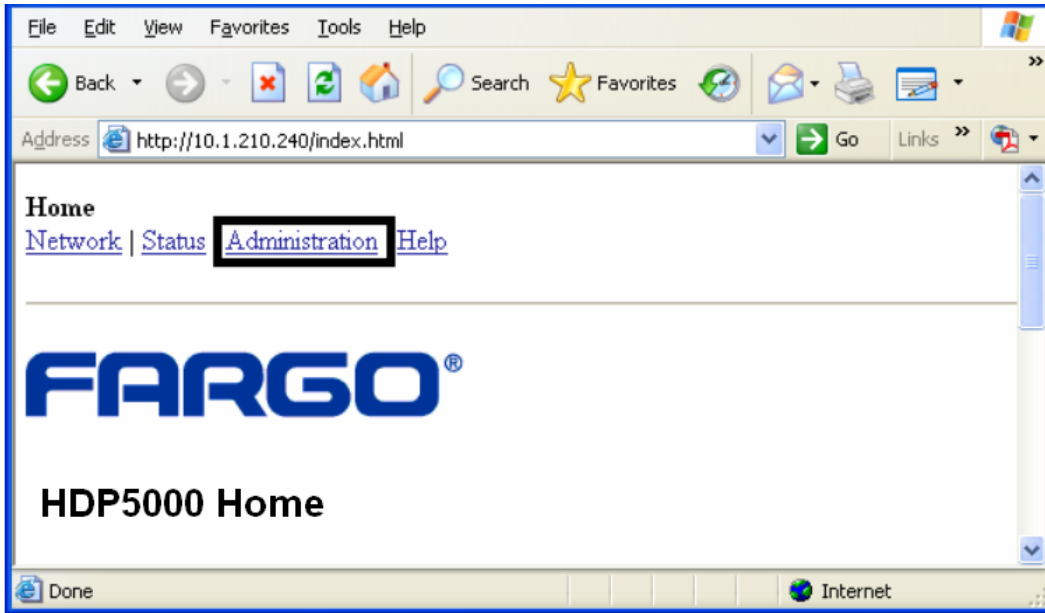

Display B – Selecting Upgrade

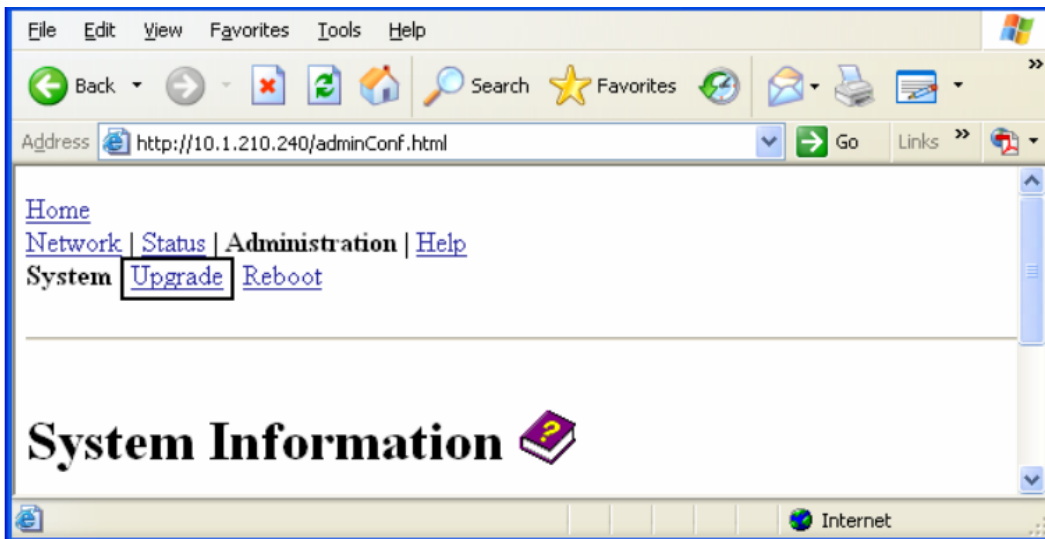

Upgrading the Main Firmware

Step	Procedure
8	Select the Browse button. See Display A below.
9	Navigate to and select the appropriate file to upload.
10	Select the Upgrade button to start the Firmware upload. See Display A below.
11	Select Reboot when requested. See Display B below.

Display A – Selecting the Browse and Upgrade buttons.

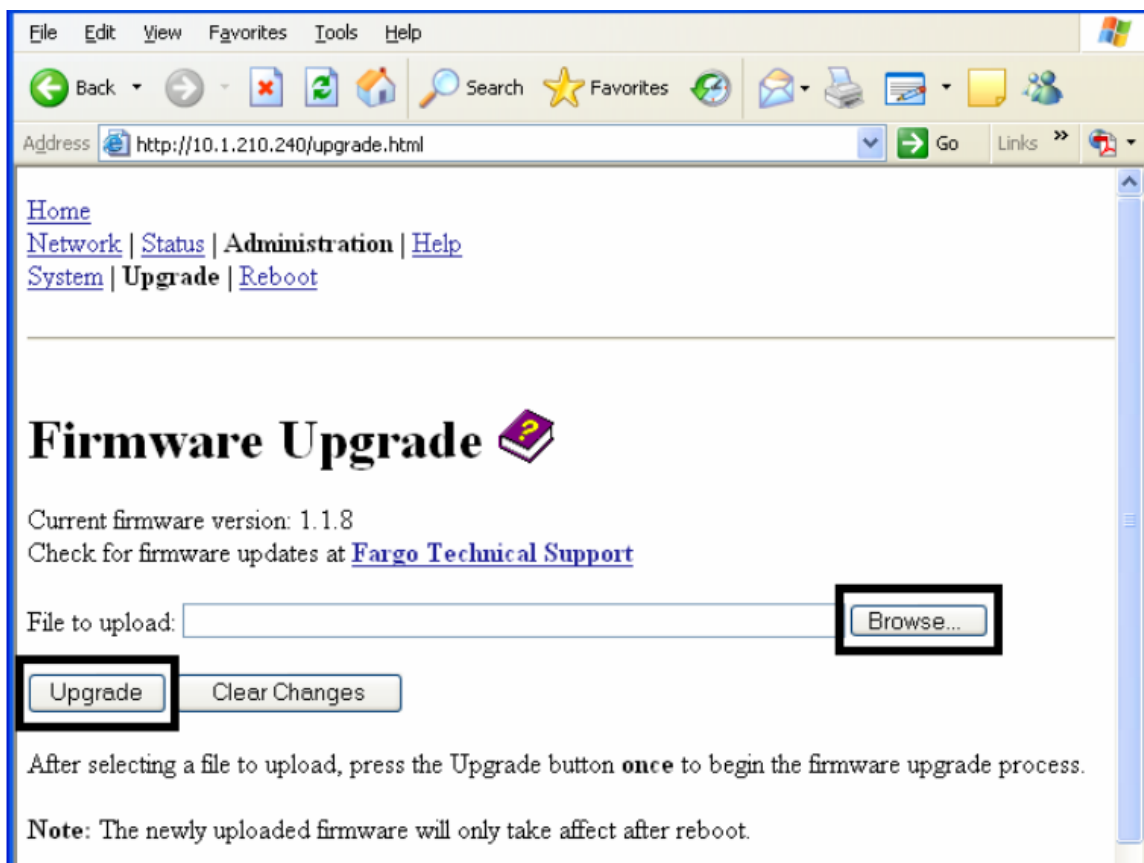

Display B – Continuing to reboot

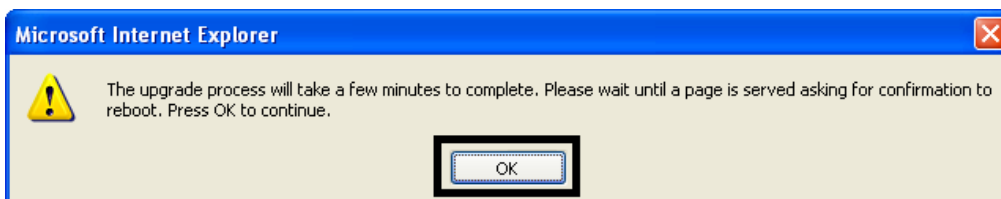

Using the Print Path page

The purpose of the Print Path page is to allow the User to view or change the TCP port numbers used to communicate to the printer.

- If these settings are left to the default entry of 0 then the default ports of 9100, 5400 and 5402 will be used for the **RawSocket TCP Port**, the **CPS Data TCP Port** and the **CPS Command TCP Port** respectively.
- The **CPS Command TCP Port** is dependent on the setting of the **CPS Data TCP Port** and always two units higher.

Step	Procedure
1	Select the Print Path link.
2	View the active configuration of the printer in the Current Settings area on this page.
3	New port numbers may be entered into the Stored Settings area in the text boxes provided on this page.

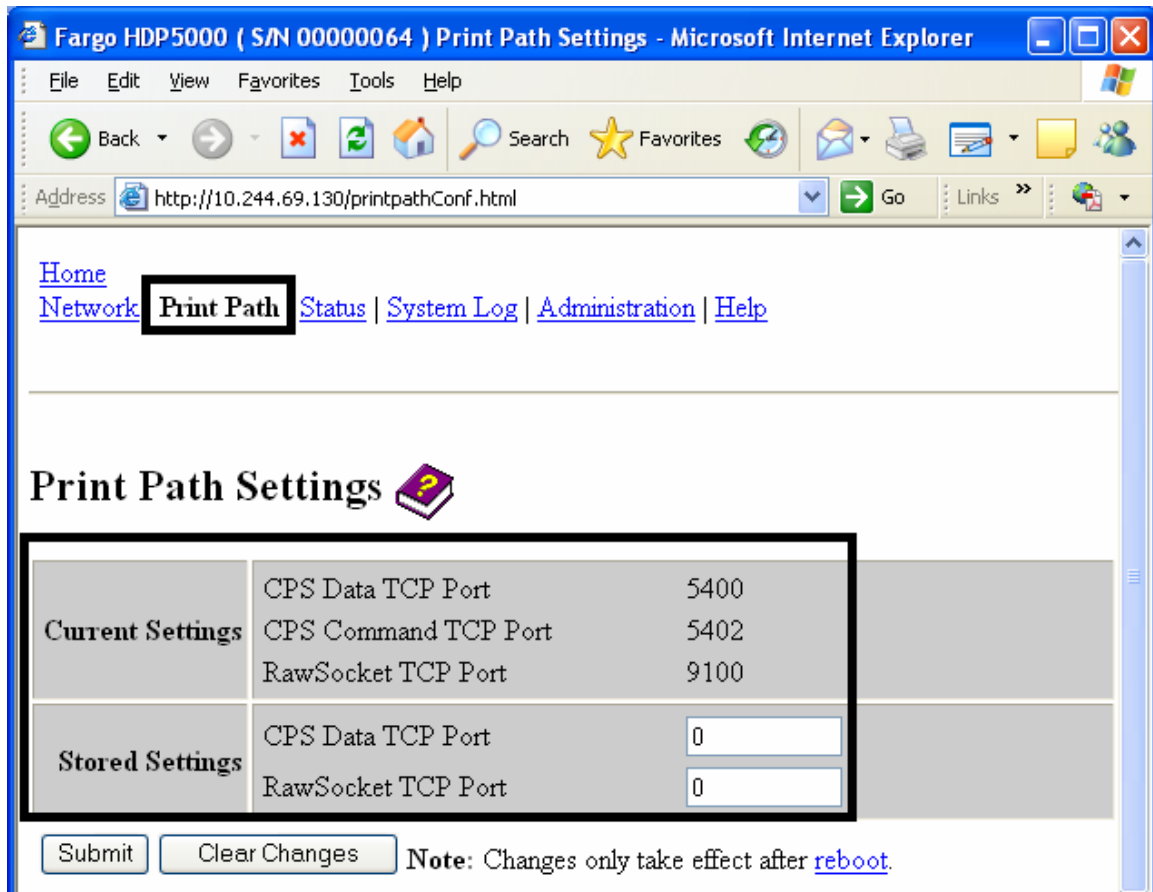

Using the Print Path page

Step	Procedure
4	Select the Submit button to save these changes to stored settings in the memory of the Printer. (Note: These settings will not be lost if the power is removed from the Printer.)
5	Select the Clear Changes button to delete these changes from this page.

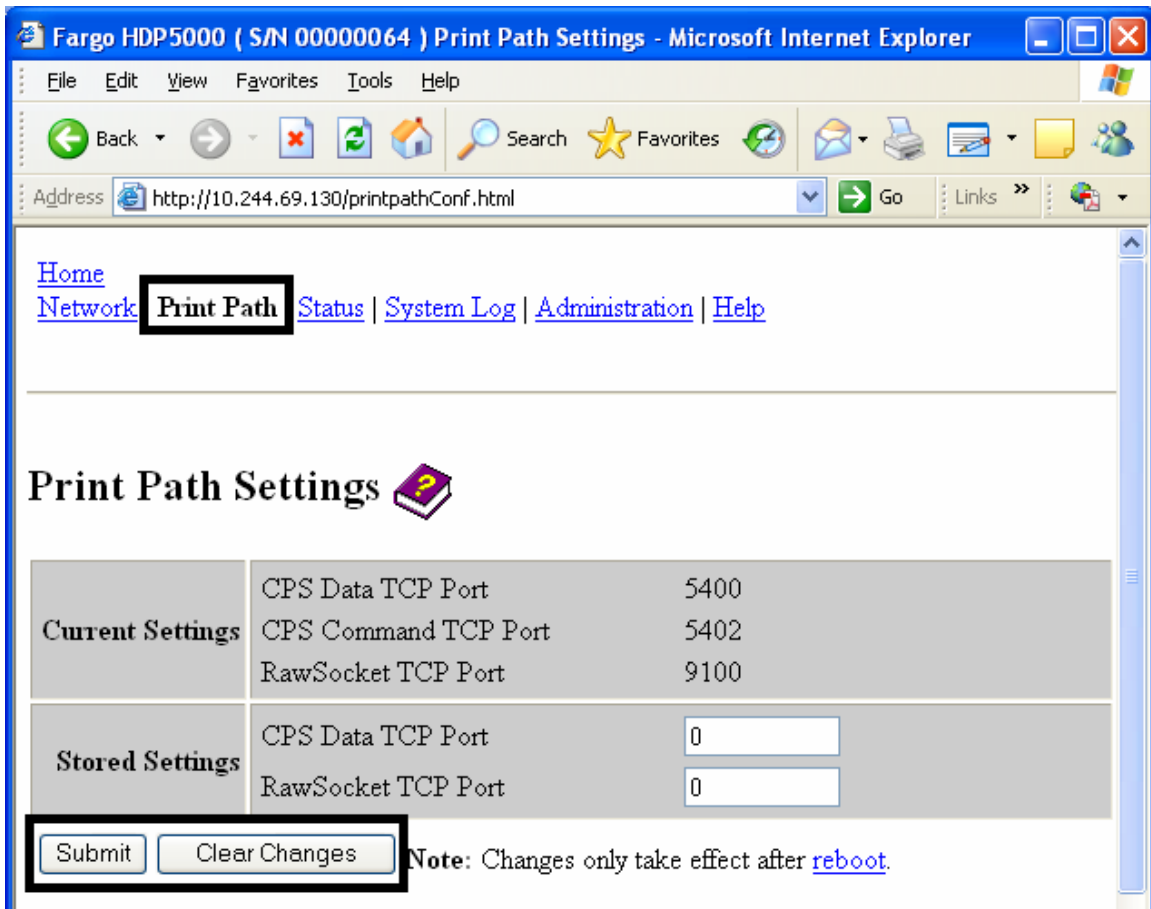

Using the Help page

The Help page displays the **Help** information.

Step	Procedure
1	Open this web page at the appropriate location by clicking on the Help book icon at the top of each page. See previous page.
2	Review the web interface for the Ethernet-enabled Printer.

Additional Ethernet Procedures

Accessing the Ethernet Status LEDs

The Ethernet Status LEDs can be found on the back of Printers.

Reviewing the HDP5000 LED Table

LED	Flash Rate	Indicates
Green LED (Left)	On	The Network link is present.
	Off	The Network link is not present.
Amber LED (Right)	Off	There is NO network traffic to this IP address.
	Blinking	There is Network traffic to this IP address.

Upgrading the Main Firmware with the Fargo Workbench Printer Utility

The Main Printer Firmware upgrades are done with the same procedure as the USB-connected Printer.

- The PC doing the upgrade must have a Driver installed for the Fargo Printer to be upgraded.
- Alternatively, a HDP5000 User can upgrade the HDP5000 Main Printer Firmware by using the HDP5000 Upgrade web page.

Step	Procedure
1	Run the Fargo Workbench Printer Utility by selecting from the start menu the following: Start -> Programs -> Fargo -> Fargo Workbench Printer Utility -> Fargo Workbench
2	Select the Fargo Printer to upgrade from the Actions Menu, as shown below.

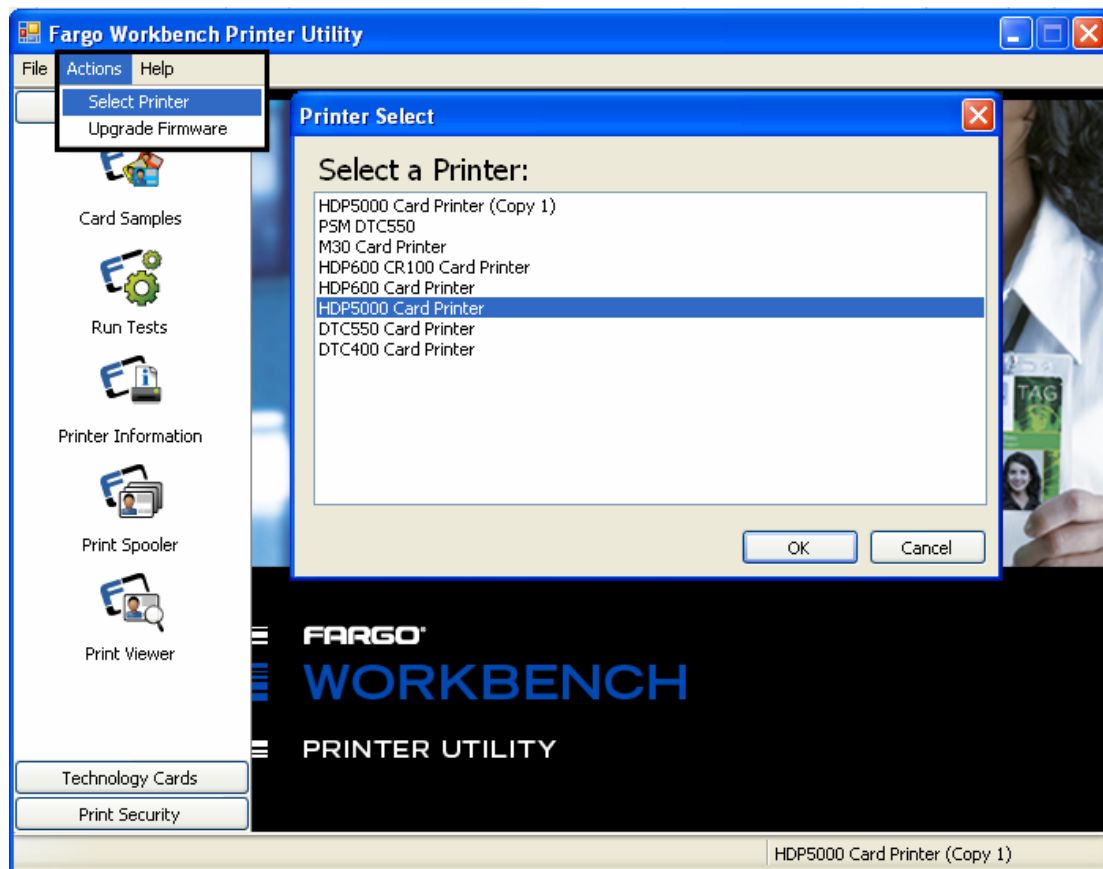

Upgrading the Main Firmware with the Fargo Workbench Printer Utility

Step	Procedure
3	Access the Upgrade Firmware window from the Actions Menu, as shown below.
4	Select the New Firmware File by clicking Browse and selecting the Firmware file from the appropriate folder.
5	Begin the upgrade by clicking Upgrade , as shown below. Refer to the Fargo Workbench Printer Utility User Guide at this time.

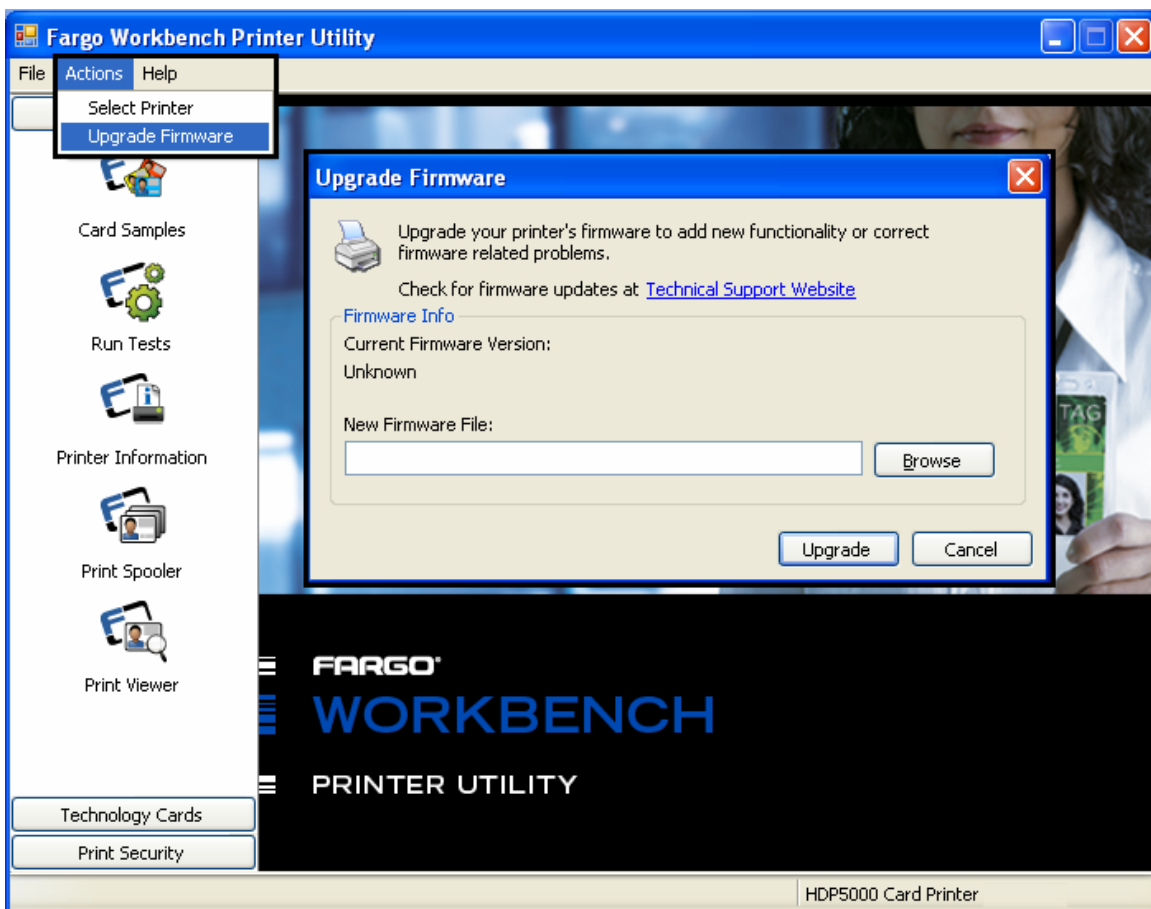

Restoring the Factory Settings for Ethernet

There may be times when you are unable to use the current configuration of the Ethernet interface. (**Note:** This could be because you have lost the password for your Printer or you just cannot get it to work properly.)

Resetting the HDP5000 settings

The HDP5000 has a menu selection that allows the User names and passwords to revert to default. To reset these settings, select:

Menu: Setup Printer: Network Settings: Reset Passwords.

Changing the HDP5000 LCD Network Settings

The HDP5000 Printer/Encoder will display new menu entries when (a) the Ethernet option is installed and (b) the Printer has established communications to a host device.

- You can use these procedures to change network settings by using the new LCD menus.

Accessing the Network Setup Menu

Step	Procedure
1	Apply power to the Printer.
2	Ensure that the Printer is connected to your network.
3	Wait up to one (1) minute to allow the Printer to configure the IP address.
4	Select Options on the LCD.
5	Select Menu on the LCD.
6	Select the Next button on the LCD until the Network Settings menu entry appears.
7	Press Select when Network Settings appears on the LCD.

Changing the DHCP Setting

Step	Procedure
1	See the Accessing the Network Setup Menu procedure to access the Network Settings menu : Options -> MENU -> Next -> Network Settings
2	Select Next on the LCD to view the DHCP menu entry. <ul style="list-style-type: none">• DHCP Enabled indicates that the automatic IP assignment is selected.• DHCP Disabled indicates that the static IP assignment is selected.
3	Press the Change button to switch the DHCP setting.
4	If you change the setting, you will be prompted to reboot the Printer.

Changing the ANEG setting

The ANEG status indicates the current setting of the network configuration of the Ethernet interface.

- This value can be set explicitly by the User to force the Ethernet interface configuration in cases where auto negotiation fails.
- Failure of the automatic network configuration can cause slow data transmission, longer print times or network connection problems.

Follow the procedure provided below.

Step	Procedure
1	See the Accessing the Network Setup Menu procedure to access the Network Settings menu (Options ->Menu -> Next -> Network Settings).
2	Select Next on the LCD to view the ANEG: menu entry.
3	Press the Change button to change the auto negotiation setting for the Printer, which will rotate between the following: <ul style="list-style-type: none"> • ANEG: AUTO: Allows the auto negotiation between the Printer and the host Ethernet interface. • ANEG: Full Dup: Forces the full duplex communications between the Printer and the host Ethernet interface. • ANEG: Half Dup: Forces the half duplex communications between the Printer and the host Ethernet interface.
4	If you change the setting, you will be prompted to reboot the Printer.

Saving addresses

Step	Procedure.
1	See the Accessing the Network Setup Menu procedure to access the Network Settings menu: Options -> MENU -> Next -> Network Settings
2	Select Next on the LCD to view the Save Addresses menu entry.
3	Press the Select button to save the current network settings (IP address, GW, SN Mask) as the stored settings which will be used when automatic address assignment using DHCP is disabled.





Resetting Passwords

Step	Procedure
1	See the Accessing the Network Setup Menu procedure to access the Network Settings menu: Options -> Menu -> Next -> Network Settings
2	Select Next on the LCD to view the Reset Passwords menu entry.
3	Press the Select button to reset the User passwords to the default settings of empty strings. (Note: This can be used when the passwords are not known.)

Accessing the HDP5000 IP Address

Follow this procedure:

Step	Process
1	Press Info in Display A (below) to continue with the procedure.
2	Press Next several times to access Display C (IP :).
3	Press Next one more time, and the IP: address LCD screen will appear. See Display D as an example.
4	Your IP address is identified in the final LCD screen. You have completed the procedure.

Display A – Printer Ready (first step)	Display B – HDP5000 (second step)
	
Display C – IP: (third step)	Display D – IP: Address (fourth step)
	

Ethernet Printer Troubleshooting Procedures

Troubleshooting procedures

If you are having trouble connecting to your Ethernet Printer or printing to it, you should go through each of the following procedures.

Step	Procedure
1	Follow the Verifying the Printer Connection procedure on the next page.
2	Follow the Verifying the Printer IP address procedure on the next page.
3	Follow the Verifying that your PC can access the Printer using the ping command procedure.
4	Verify that you are choosing the correct Printer Driver. (Note: The Driver must match the model of the Printer.)
5	Verify that the port configuration of the PC Printer Driver is set to communicate to the Printer over the correct IP address.
6	Follow the Printing a test page procedure.

Verifying the Printer Connection

Step	Procedure
1	Ensure that your Printer has a valid network connection.
2	Verify that the HDP5000 has the green LED on solidly and the amber LED is flashing with network activity.
3	If the LEDs do not indicate connection, verify the network connection with another device.
4	If the connection is OK, then something may be wrong with the Ethernet option installation. See the Ethernet Printer Troubleshooting Procedures procedure.

Verifying the Printer IP address

Step	Procedure
1	Check the LCD for a valid IP address (0.0.0.0 is not valid). <ul style="list-style-type: none"> • If the IP address is valid go to step 4. • If the IP address is not valid go to step 2.
2	If your network is using DHCP, then verify that the Printer has not been configured to use a static address (unless you have a known unused static IP address assigned to this Printer).
3	If you are using a static IP address, verify that there is no other device using the same address by removing your Fargo Printer and ping to the desired address. If any device responds, then you must find a different available IP address.
4	If the Printer reports an IP address, verify that it matches subnet of the network where it is connected. If your Printer has DHCP disabled, then the static IP address may have been previously set for a different subnet.

Verifying that your PC can access the Printer using the ping command

Step	Procedure
1	<p>Follow these instructions to issue a ping command to the Printer:</p> <p>At a DOS prompt, enter ping [IP Address]</p> <p>Example: C:\>ping 210.1.10.240</p> <ul style="list-style-type: none"> • If the ping response is successful, move on to the next troubleshooting procedure. See Display A below. • If the ping response is not successful, continue to step 2 of this procedure. See Display B below.

Display A - Example of sending a ping to the Printer with a successful response

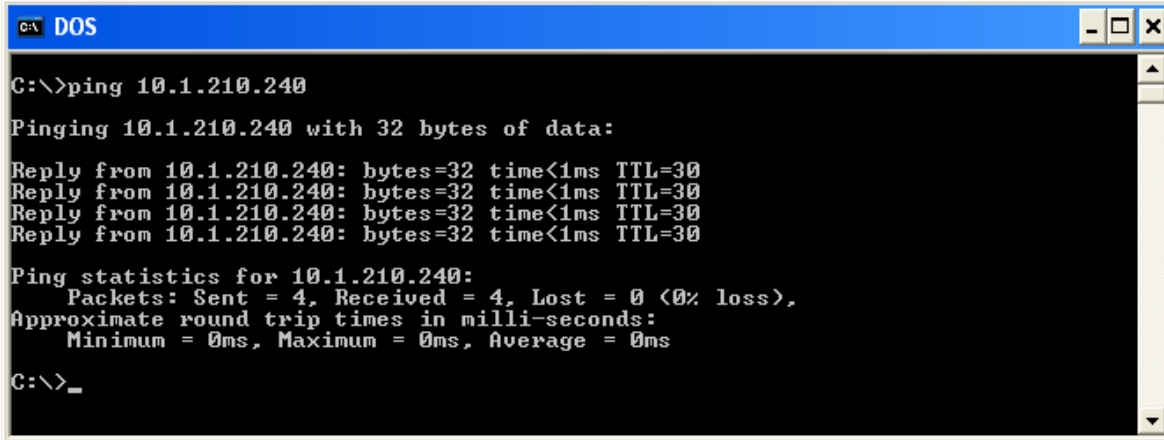

```

C:\>ping 10.1.210.240

Pinging 10.1.210.240 with 32 bytes of data:

Reply from 10.1.210.240: bytes=32 time<1ms TTL=30
Reply from 10.1.210.240: bytes=32 time<1ms TTL=30
Reply from 10.1.210.240: bytes=32 time<1ms TTL=30
Reply from 10.1.210.240: bytes=32 time<1ms TTL=30

Ping statistics for 10.1.210.240:
    Packets: Sent = 4, Received = 4, Lost = 0 (0% loss),
    Approximate round trip times in milli-seconds:
        Minimum = 0ms, Maximum = 0ms, Average = 0ms

C:\>_

```

Display B - Example of ping timeout to an invalid IP address

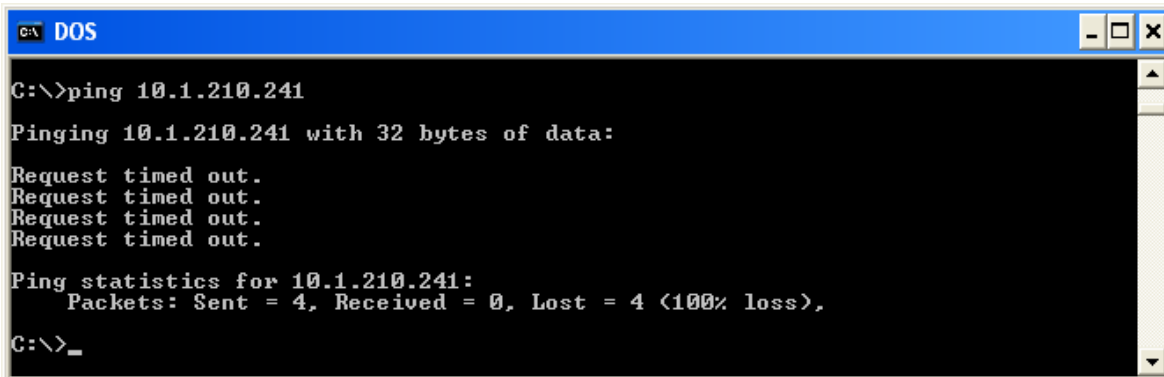

```

C:\>ping 10.1.210.241

Pinging 10.1.210.241 with 32 bytes of data:

Request timed out.
Request timed out.
Request timed out.
Request timed out.

Ping statistics for 10.1.210.241:
    Packets: Sent = 4, Received = 0, Lost = 4 (100% loss),

C:\>_

```

Verifying that your PC can access the Printer using the ping command

Step	Procedure
2	Verify that the PC and the Printer are connected to the same network.
3	<p>You may be on different subnets of your network and some of the network settings for the Printer are not correct. See your network administrator about this.</p> <p>(Note: The subnet mask must be the same as other devices on the network, and that the unique IP address is part of the network specified by the subnet mask.)</p>

Printing a test page

Step	Procedure
1	Try printing a test page from the Printer Driver properties window.
2	<p>If you cannot print a test page, then consider the following:</p> <ul style="list-style-type: none"> • There may be an error at the Printer. • There may be a job in the Windows print queue which has stalled. • The Printer may be paused or set to operate offline in the Windows print queue.

Reviewing Frequently-asked Questions-Ethernet

Question	Answer
How do I know if my Printer has the Ethernet option installed?	All HDP5000 models come with Ethernet installed as standard equipment.
What PC operating systems work with my Ethernet Printer?	The Windows 2000/ XP / Server 2003 operating systems work with your Ethernet Printer.
How do I connect my Printer to my network?	You can connect from the RJ45 network connection on the back of your Printer to an available connection on your network (not directly to your PC). You can use a good CAT-5 or better cable to make this connection.
How can I find the MAC address of my Ethernet Printer?	<ul style="list-style-type: none"> • If you know the IP address of your Printer, you can see the MAC address on the home web page of the Print Server. <p style="text-align: center;">OR</p> <ul style="list-style-type: none"> • If you do not know the IP address or the Printer does not work with a usable IP address, then the MAC Address can be found by two methods. These are: <ol style="list-style-type: none"> 1. The MAC address is listed in the data printed on the "Printer Settings" self-test card. 2. The Fargo IP-Tracer software tool on the driver CD can be used to find the MAC address of the printer. (Note: This can be installed and used to locate all the Fargo compatible Printers on your network.)

Reviewing Frequently-asked Questions-Ethernet

Question	Answer
How can I find the IP address of my Ethernet Printer?	<p>You can find it in the LCD of the Printer if the Ethernet option is functioning properly.</p> <p>Select Info, then select Next several times until the IP address is shown.</p>
Can I print from my PC to multiple Ethernet Printers?	<p>Choose "Local printer..." unless a shared network printer is to be installed on a print server.</p> <p>Use the Windows "Add Printer Wizard" to create a printer instance to communicate to the printer at the new IP address.</p> <p>If the printer port is not listed as an existing port then a new "HDP5000 TCP/IP Card Printer Port" must be created and configured to communicate to the printer at the proper IP address.</p> <p>See the appropriate Windows documentation for additional help.</p>
Can multiple PC's print to my Ethernet Printer?	<p>Yes. Each PC must install the Printer Driver software for the specific Fargo Ethernet-enabled Printer and connect to the intended Printer, using the correct IP address.</p>
Can I print from my PC to an Ethernet Printer on a different network segment?	<p>Yes. If you know the IP address of the Printer on any segment of your network, you will be able to print to it.</p>
Can I use Fargo IP-Tracer to locate Printers on a different network segment?	<p>No. The IP-Tracer can only locate Fargo-compatible Printers located in the same network segment (as the PC running IP-Tracer).</p>

Reviewing Frequently-asked Questions-Ethernet

Question	Answer
<p>How do I upgrade the Printer Firmware in my Ethernet-enabled Printer?</p>	<p>This is done in the same manner as a USB-connected Printer. The PC doing the upgrade must have a Driver installed for the Fargo Printer to be upgraded.</p> <p>Follow this procedure.</p> <ol style="list-style-type: none"> 1. Run the Fargo Workbench Printer Utility from the start menu: Go to the Start -> Programs -> Fargo -> Fargo Workbench Printer Utility -> Fargo Workbench. 2. Select the Fargo Printer to upgrade from the drop-down box. 3. Go to the Firmware Updates tab. 4. If you need to download the update file from the Internet, select the Download Firmware button. 5. Choose the update file with the Select Firmware button. 6. Put your Printer into the upgrade mode. See the instructions for your specific Fargo Printer. 7. Select the Send Firmware button.
<p>How do I upgrade the Print Server Firmware for my HDP5000 Printer?</p>	<p>Since the Print Server is integrated into the main print Firmware on the HDP5000, there is not a separate Firmware upgrade for the Printer Server. (Note: Therefore, the upgrades are done with the main Printer Firmware.)</p>
<p>What is the default User name and password for the Printer?</p>	<p>The default passwords are blank (i.e., an empty string).</p> <ul style="list-style-type: none"> • The default Users are as follows: root as the administrative User and guest as a non-administrative User. • The HDP5000 supports two (2) Users.

Reviewing Frequently-asked Questions-Ethernet

Question	Answer
What if I lose the password for my Printer or it is not accepted?	<p>The HDP5000 has a menu selection that allows the User names and passwords to revert to default:</p> <p>Options > Menu > Network Settings > Reset Passwords</p>
What do I do if the IP address of my Printer is being changed by my network?	<p>Follow this procedure:</p> <ol style="list-style-type: none"> 1. Contact your network administrator. Ask that your current IP address be reserved or ask that they provide a specific IP address that you can use to configure the Ethernet interface. <p>OR</p> <ol style="list-style-type: none"> 2. Choose an IP address that you know will not be used by any other PC, server or network device. Use those settings to configure your Printer with static network settings. <p>(Caution: Do not do this unless you know that these settings will always be available.)</p>
How do I reconfigure my PC Printer Driver to connect to a different Printer or different IP address?	<p>Choose “Local printer...” unless a shared network printer is to be installed on a print server.</p> <p>Use the Windows “Add Printer Wizard” to create a printer instance to communicate to the printer at the new IP address.</p> <p>If the printer port is not listed as an existing port then a new “HDP5000 TCP/IP Card Printer Port” must be created and configured to communicate to the printer at the proper IP address.</p> <p>See the appropriate Windows documentation for additional help.</p>

Reviewing Frequently-asked Questions-Ethernet

Question	Answer
<p>How can I verify/change what IP address my installed Printer Driver is expecting to find my Printer?</p>	<p>Follow this procedure.</p> <ol style="list-style-type: none"> 1. Open the Printer Driver properties window. 2. Select Start -> Settings -> Printers and Faxes -> [your Printer Driver] -> Properties. 3. From the Ports tab, select Configure Port. The Host name will indicate IP address of the connected Printer. (Note: If this does not match your Printer's IP address, you can change it from this window.) 4. Enter the correct IP address. 5. Select OK. 6. Select Apply. 7. Select Close.
<p>How do I configure my Printer's IP settings?</p>	<ul style="list-style-type: none"> • By default, the Printer is configured for dynamic IP address assignment. That is, it will try to get its IP address and other settings from your network. If it is given valid network settings, it will use them. <p style="text-align: center;">OR</p> <ul style="list-style-type: none"> • You can choose to configure the Printer, using a static IP address and network settings. (Note: This can be entered using the Network web page of the Printer or the Fargo IP Tracer program.)
<p>How do I choose a static IP address for my Ethernet Printer?</p>	<p>You can use the web pages if you know the current IP address. See the Accessing the Home page procedure.</p> <p>OR</p> <p>You can use Fargo IP-Tracer which allows you to find Fargo-compatible Printers and specify their addresses.</p> <p>The HDP5000 also allows you to save the current network settings as static settings via the LCD menu (Options: Menu: Network Settings: Save Addresses).</p> <p>(Note: You can save static addresses. However, they are not used until you reconfigure the Printer to use those static addresses and reboot the Printer.)</p>

Reviewing Frequently-asked Questions-Ethernet

Question	Answer
<p>How do I set the Printer to work with a static IP address?</p>	<p>You can use the web pages if you know the current IP address.</p> <ul style="list-style-type: none"> • Select the Use the following IP address button on the Network web page. <p>OR</p> <ul style="list-style-type: none"> • Use Fargo IP-Tracer, which allows you to find Fargo compatible Printers and specify their addresses. <p>The HDP5000 also allows you to use the LCD menus to save the current IP addresses as static (see above) and then switch DHCP (dynamic IP address selection) to DISABLED:</p> <p>Options: Menu : Network Settings: DHCP: Change</p>
<p>What do the LEDs by the Ethernet connection on the back of the Printer indicate?</p>	<ul style="list-style-type: none"> • On the HDP5000 Printer: The green LED indicates a valid Ethernet connection. The amber LED indicates network activity.
<p>How do I print a test page from Windows to verify the Ethernet configuration of the Printer and Printer Driver?</p>	<p>Follow this procedure.</p> <ol style="list-style-type: none"> 1. Open the Printer Driver properties window. 2. Select Start -> Settings -> Printers and Faxes -> [your Printer Driver name (i.e., HDP5000 Card Printer)] -> Properties. 3. Ensure that the printing preferences are set correctly for the Ribbon installed in your Printer. Then select the Print Test Page button.

Glossary of Terms

Term	Purpose
MAC (Media Access Control)	The unique numeric value address associated with a network device that gives the device a unique identity. This address is assigned by the device manufacturer to ensure its uniqueness.
TCP (Transmission Control Protocol)	The Network protocol that allows reliable network communications between devices.
IP (Internet Protocol)	The Network protocol that identifies devices and messages by addresses so that communications can occur between devices on different local networks.
TCP/IP	Network communications using TCP and IP protocols.
ICMP (Internet Control Message Protocol)	The Basic message protocol for the internet.
DHCP (Dynamic Host Configuration Protocol)	The protocol used by a network to automatically assign network settings to connected devices so that they will work together.
DNS (Domain Name System)	Defines the Network protocol that allows devices to find IP addresses from a network name server.

Glossary of Terms

Term	Purpose
DNS Server Address	This is the address of the server that provides the translation from a descriptive name to an IP address.
DNS Domain Suffix	This is the suffix to be added to the domain name to make a complete name.
SNMP (Simple Network Management Protocol)	This is protocol for the network management services. This protocol provides a means for network compliant devices, called agents, to store data about themselves in Management Information Bases (MIBs) and return this data to the SNMP requesters.
MIB (Management Information Base)	A formal description of the way an agent can be accessed using SNMP and the functions that can be managed.
Network Settings	The basic network parameters needed to configure the network interface. (Note: These include the IP Address, the Subnet Mask, the Default Gateway, the DNS Server Address and the DNS Domain Suffix.)
IP addresses	Specifies the current IP addresses that are 32-bit values that are normally expresses in dotted-quad format. (Note: This address must not be the same as another device on the same local network.)
Subnet mask	Specifies a 32-bit value that routers use to send a message to the correct subnet.
Default gateway	Specifies the address of the router (in a network using subnets) that forwards traffic to a destination outside of the subnet of the transmitting device.

Glossary of Terms

Term	Purpose
Telnet	This is a common terminal emulation program that allows a User to send commands to a TCP/IP connected device and receive the responses.
UDP (User Datagram Protocol)	Defines a protocol for sending and receiving messages on a network.
Syslog	The standard method for logging system events.
Root User	A User with administrative rights to change any Printer settings.
Guest User	A User without rights to change Printer settings.
Ping	A common utility or command that sends a message to network devices asking for a return message. (Note: This is used to diagnose if the device is on the network or to troubleshoot the connection.)

Section 8: Card Lamination Module

The HDP5000 supports the attachment of an optional Card Lamination Module. This Module can be ordered pre-installed on the Printer from the factory or can be ordered separately as a field upgradeable Module.

Once attached, the Card Lamination Module allows you to apply Fargo certified overlaminates for more secure, tamper-resistant cards. This section explains all aspects of the Card Lamination Module's operation and the overlaminate materials available.

See [Using the Lamination tab \(HDP5000-LC\)](#).

IMPORTANT! Fargo Card Printers require highly specialized Print Ribbons to function properly. To maximize Printer life, reliability, printed card quality and durability, you must use only Fargo Certified Supplies. For this reason, your Fargo warranty is void, where not prohibited by law, if you use non-Fargo Certified Supplies. To order additional materials, please contact your authorized reseller.

Printer Unit: Reviewing the Card Lamination Module



Danger: The Printer's Transfer Roller can reach temperatures exceeding 350° F (175° C). Use extreme caution when operating the Laminator. Never touch the Transfer Roller unless the Printer has been turned off for at least 20 to 30 minutes.

Select Printer models support the attachment of an optional Card Lamination Module. This Module can be ordered pre-installed on your Printer from the factory or can be ordered separately as a field upgradeable Module.

Reviewing the Card Lamination Module



Installing the Card Lamination Module

Introduction

The following guide provides a step-by-step installation procedure for the HDP5000 Lamination Module and Printer Driver Accessory. Refer to the HDP5000 High Definition Card Printer/Encoder User Guide for details on operating your new card Lamination Module.

The time required for each installation is provided below:

- **Lamination Module Installation (time required):** This hardware installation process will require approximately 10 to 15 minutes.
- **Driver Software Installation (time required):** This software installation process will require approximately 2 to 6 minutes (depending on the speed of your PC).

Inspecting the Card Lamination Module

While unpacking your Lamination Module, inspect the carton to ensure that no damage has occurred during shipping. (**Note:** Make sure that all supplied accessories are included with your unit.)

Your new Lamination Module is packaged in a standard HDP5000 Card Printer/Encoder carton. (**Note:** It is recommended that you save the packaging in the event that you need to transport the Card Printer/Encoder/Laminator at a future date.)

Unpacking the Card Lamination Module

The following items are included with your new Lamination Module:

- Card Lamination Module
- Power Supply with a Power Cord (for the Card Lamination Module)
- Warranty Card

Choosing a proper Location

Follow these guidelines:

- Place the unit in a location with adequate air circulation to prevent internal heat build-up.
- Use the Printer's dimensions (10.75 H x 35.5 W x 13 D) as a guideline for the minimum clearances to the unit. (**Note:** Allow for adequate clearance above the unit to accommodate the height of the unit with its Covers open.)
- Do not install the unit near heat sources, such as, radiators or air ducts.
- Do not install the unit in a place subject to direct sunlight, excessive dust, mechanical vibration or shock.

Preventing Moisture Condensation

If the unit is brought directly from a cold to a warm location or if the unit is placed in a very damp room, moisture may condense inside the unit. (**Note:** If this condition occurs, print quality may not be at its optimum level.)

Follow this guideline:

- Leave the unit turned OFF in a warm, dry room for several hours before using it. (**Note:** This will allow the moisture to evaporate.)

Installing the Lamination Module Accessory

Parts included: Lamination Module Accessory Kit, PCB-INTF Board, Torx Tool and screws.

Tools needed: Torx Tool included in kit.

Estimated Repair Time: 10 minutes.

Step	Procedure
1	 Caution: Power off the Printer by unplugging the power cord from the Printer.
2	Remove the USB, Serial, Ethernet communication connections. Important: Do not remove the Covers for this procedure.
3	The Lamination Module is installed at the output side of the Flipper Module. OR If there is no Flipper Module, it is installed at the output side of the Printer. Remove the Card Output Hopper.
4	a. Remove the Output Side Upgrade Cover (D910139-01). b. Release the latch on the upgrade cover. c. Pull on the bottom of the upgrade cover to remove it from the printer.
5	a. Turn the Printer and the Flipper Module on their back. b. Use the Torx tool provided to remove the two (2) screws from the bottom of the Flipper Module. Save the screws for later for reattachment.

Installing the Lamination Module Accessory

Step	Procedure
6	Slide the Lamination Module attachment tabs and the PCB-INTF Board into the appropriate slots at the base of Printer or Flipper Module.
7	Use the two (2) screws provided to attach the Lamination Module to the Printer. See Display A on the next page.

Display A - Shows the Printer, the Flipper Module and the Lamination Module. Slide the Lamination Module attachment tabs and the PCB-INTF Board into the appropriate slots at the base of Printer or Flipper Module.

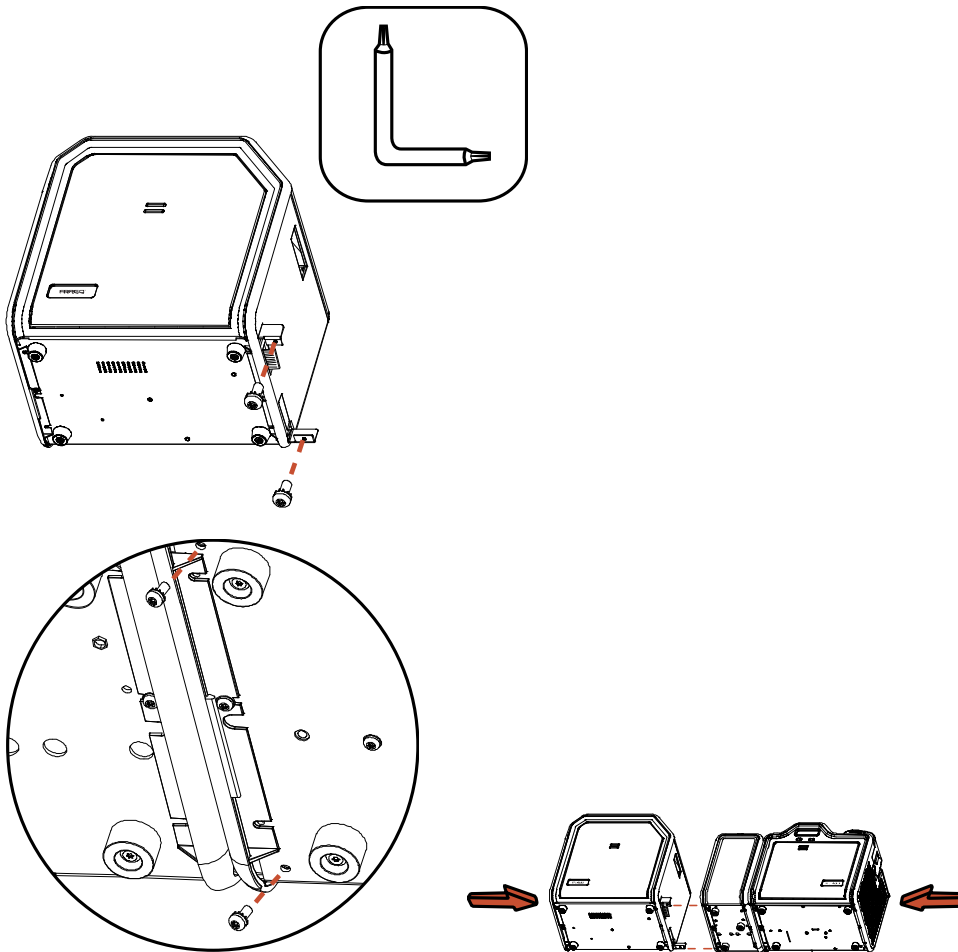

Adjusting the Lamination Placement on the Card

The Card Lamination Module provides an adjustable Lamination Placement knob that allows you to fine-tune where the lamination is being placed on the card.

Step	Procedure
1	<p>See Display A (below).</p> <ul style="list-style-type: none"> The Lamination Placement Adjustment Knob is the light gray knob to the right of the Lamination Cartridges. The printer will have one or two film cartridges loaded (depending on whether this is a Single or Dual-Side Lamination Module).
2	<p>Print a test card to see if the Lamination needs to be adjusted.</p> <ul style="list-style-type: none"> Turn the knob to the right (the negative sign) to move the patch toward the front edge of the Lamination Module. Turn the knob to the left (the positive sign) to move the patch toward the back edge of the lamination module. Refer to the instruction diagram label located on the open front cover to make this adjustment. See Display B (below).

Display A – See Procedural Step 1 (above)

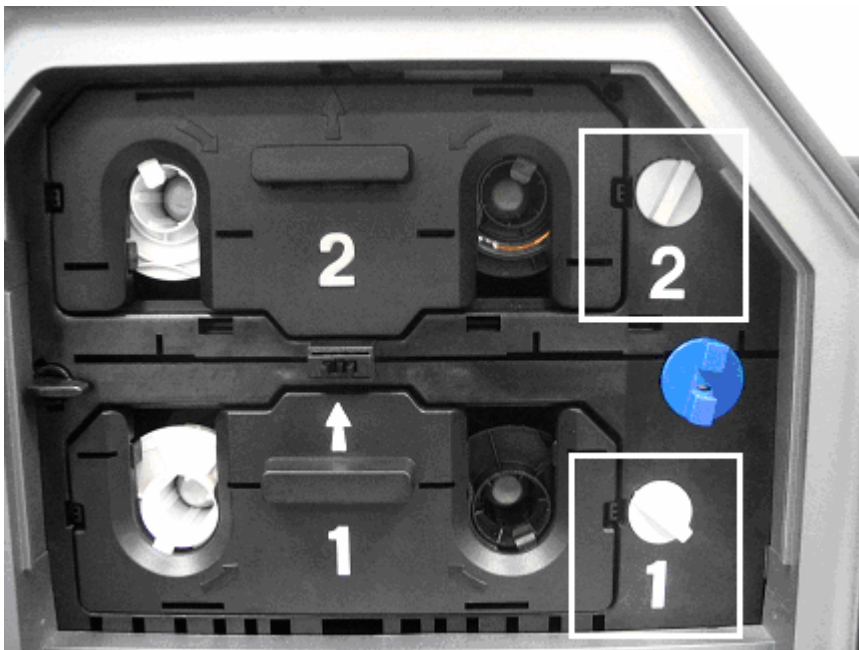

Adjusting the Lamination Placement on the Card

Display B – See Procedural Step 2

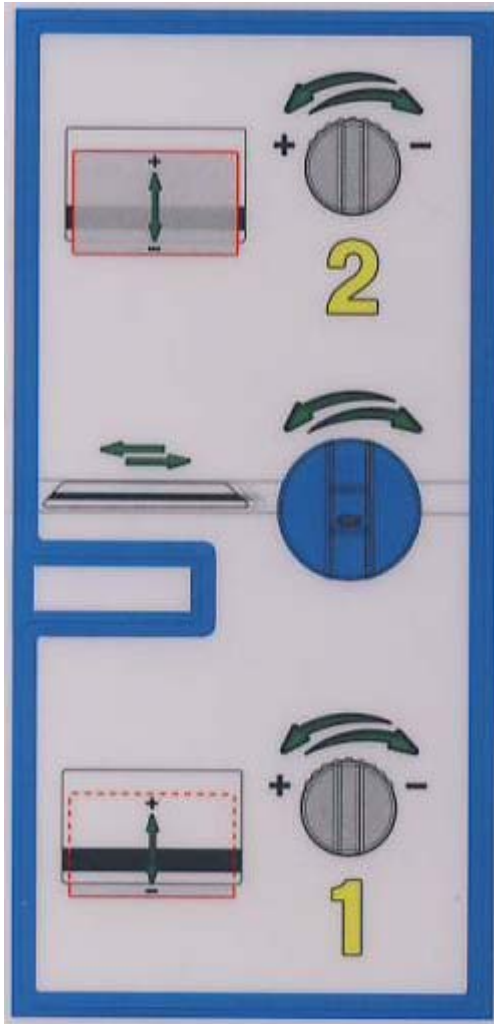

Adjusting the Card Flattener

The Card Lamination Module provides an adjustable Card Flattener that allows you to fine-tune the flatness of laminated cards. This flattener works by reverse bending cards as they travel through the Laminator while they are still warm.

In most cases, card warpage is only a concern when laminating on a single side of card stock which has a PVC-based core rather than a polyester-based core. Cards with a PVC-based core are not as heat resistant and are not recommended for use when laminating

By default, the Card Flattener is configured at the factory to accommodate UltraCard III type card stock. **(Note:** If you are experiencing an unacceptable amount of card warpage, please refer to the following to adjust the Card Flattener.)

Step	Procedure
1	Open the Front Cover of the Card Lamination Module.
2	<p>The Card Flattener Adjustment Knob is the black knob on the left side of the Laminator. Follow this instruction:</p> <ul style="list-style-type: none"> If laminated cards are bowing downward, turn the Card Flattener Adjustment Knob counter-clockwise. (Note: This creates more contact between the Flattener Roller and the card in order to increase the reverse bending pressure.) For best results, depress the knob and turn it 15 degrees, then print and laminate a test card. Repeat this process as necessary.
3	<p>If the card is bowing upward, the reverse bending pressure may be too great. Follow this instruction:</p> <ul style="list-style-type: none"> In this case, rotate the adjustment knob clockwise. (Note: Some card types have very low heat resistance and may not be acceptable for laminating.)

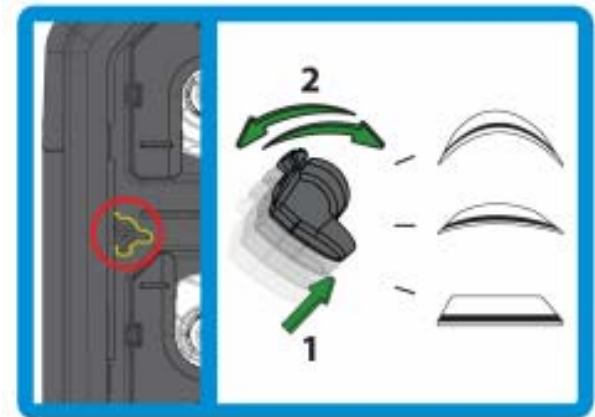

Section 9: Printer Adjustments

The purpose of this section is to provide the User with specific information on Printer adjustment procedures.

Important! Fargo Card Printers require highly specialized Print Ribbons to function properly. To maximize Printer life, reliability, printed card quality and durability, you must use only Fargo Certified Supplies. For this reason, your Fargo warranty is void, where not prohibited by law, if you use non-Fargo Certified Supplies. To order additional materials, please contact your authorized reseller.

Printing on Alternate Card Stocks

Selecting the Right Cards and optimizing the HDP Print Process

In order to optimize the HDP Card Printer's capabilities for cards with hard-to-print surfaces, we recommend evaluating the card stock selection before installation of the Printer.

The variability in cards based on:

- **Different surface textures and different sources of raw materials:** This may require different HDP Film transfer parameters.
- **Varied methods of assembling IC smart cards and proximity cards:** These particular adhesives used to glue a smart chip to a plastic card may react differently to a Transfer Roller's pressure and temperature.
- **Cleanliness of card stock:** The HDP process does not eliminate the need to use clean card stock. The best-looking card always starts with the cleanest card surface. Dirt and debris on a card can show up as blemishes on the card surface and may reduce the life of the image itself.

Conducting the Tape Adhesion Test

It is important to conduct tape adhesion tests because Fargo cannot be certain which transfer temperature and Dwell Time will work best (when printing cards other than UltraCard III). (**Note:** The optimal transfer settings may vary from card type to card type.)



Caution: Inadequate time and temperature could produce cards that are more vulnerable to accelerated wear and dye migration. Use sufficient time and temperature to transfer HDP Film to the card to ensure a long lasting, durable card.

Step	Procedure
1	Test the adhesion quality of the HDP Film to the card by printing sample cards and completing an adhesive tape test.
2	Select the UltraCard IIIs-Glossy PVC if the card is glossy and print a test card.
3	<p>a. Apply a strip of ½ (12mm) wide Scotch-type clear adhesive tape (such as 3M brand 600), at least 2 (50mm) long, firmly across the surface of the card, pressing out all air bubbles with a fingertip.</p> <p>b. Remove the tape by smoothly and rapidly (approximately 2 inches/second (50mm/sec)) pulling it up at a perpendicular (90 degree) angle to the card. (Note: The IPC recommends a minimum of three tests for each card type evaluation.)</p>
4	<p>Visually examine the card and the strip of tape pulled from the card, to see if any portion of the HDP Film was removed from the card.</p> <ul style="list-style-type: none"> • If any residue (e.g., oil or grease from fingertips) is present on the card surface, the evaluation results may be affected. • If the printed, transferred HDP Film particles (a) pull away from the card and (b) adhere to the tape, this indicates that inadequate adhesion of the HDP Film to the card. Increased heat and Dwell Times are necessary to resolve this problem. <p>Samples 1, 2 and 3 show a representation of the adhesion level you can expect.</p> <ul style="list-style-type: none"> • Result 1: Sample 1 shows a significant transfer to the tape and is an absolute failure. • Result 2: Sample 2 shows that <u>very slight</u> transfer to the tape can be acceptable without sacrificing overall image durability on matte finish cards. • Result 3: Sample 3 shows no transfer to the Tape and is an Absolute Pass.

Conducting the Tape Adhesion Test

Step	Procedure
5	<p>If the tape test indicates inadequate adhesion, increase the heat setting by 5 degrees, print another card and try the tape test again.</p> <ul style="list-style-type: none"> Once the temperature has been increased 4 times (20 degrees), reset temperature to default and increase the Dwell Time by .5 second. Repeat this process until adequate adhesion is achieved. Ensure that the cards (in use) have a surface roughness (Ra) of 60 micro inches or less. <p>This information should be available from the card manufacturer.</p>



Section 10: Toolbox

This section describes the Toolbox function.

Accessing the Toolbox

Step	Procedure
1	<p>Select Toolbox to access the Toolbox window and its tabs, as shown throughout this section.</p> <ul style="list-style-type: none"> • OK button: Closes the dialog box and saves the Driver configuration changes since the Driver dialog box has been opened. • Cancel button: Closes the dialog box and cancels the Toolbox changes since the Driver dialog box has been opened. • Help button: Launches Help specific to the active tab.

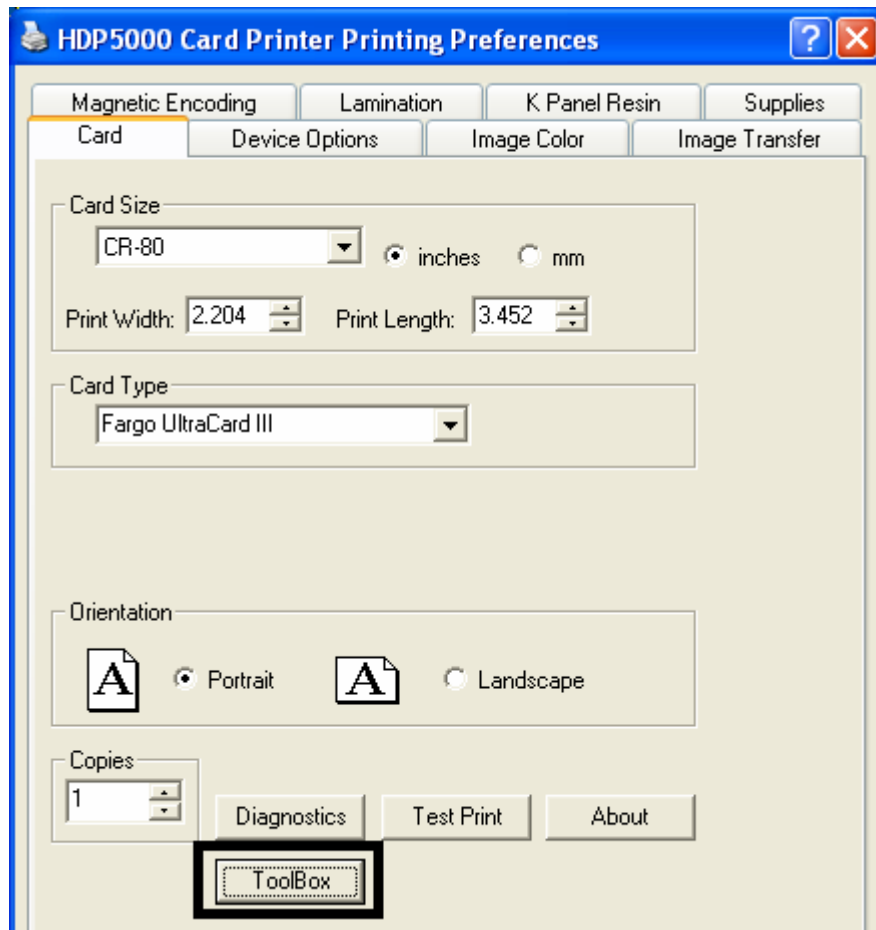

Selecting the Configuration tab

Step	Procedure
1	<p>Select the Configuration tab.</p> <ul style="list-style-type: none"> Under Printer Features, select features by clicking on a check box or by clicking on the Auto Select button. See instructions provided under that heading. Under Event Monitoring, select events to be monitored. (Note: The Driver will notify or prompt the User when the selected events occur.) Under Set Language for Printer LCD Display, select a language.

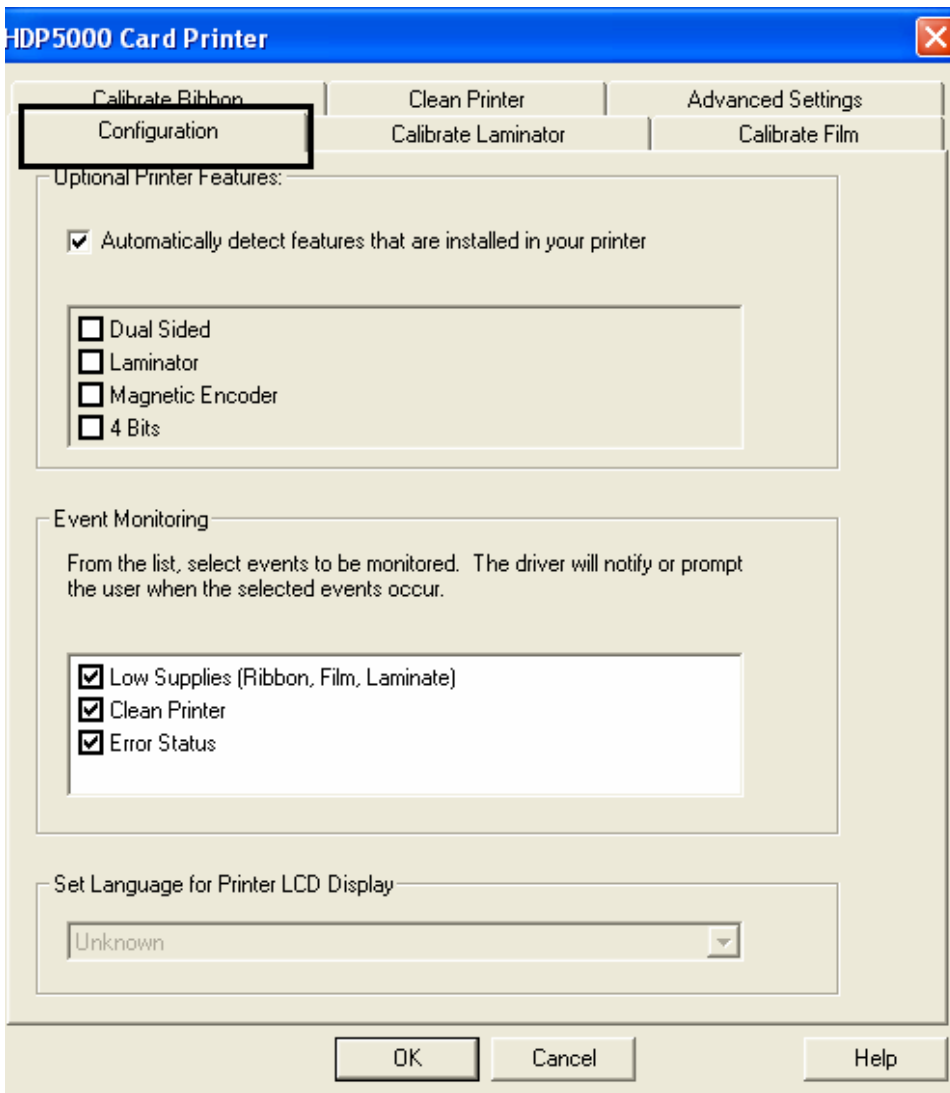

Using the Configuration Tab

Using the Optional Printer Features Group Box

The Default setting is checked.

- If checked, upon **Configuration** tab activation, the Driver retrieves the installed Printer features information from the Firmware and automatically checks the appropriate check boxes for Dual Sided, Lamination and Magnetic Encoder.
- If checked, the Dual Sided, Laminator, and Magnetic Encoder checkboxes are read only.
- If checked and no Printer is found or bi-directional capabilities are disabled or unavailable, the error message (shown below) is displayed.
- If unchecked or cleared, feature check boxes become active and can be manually set.
- If the Driver is reinstalled, it resets to the default of checked.

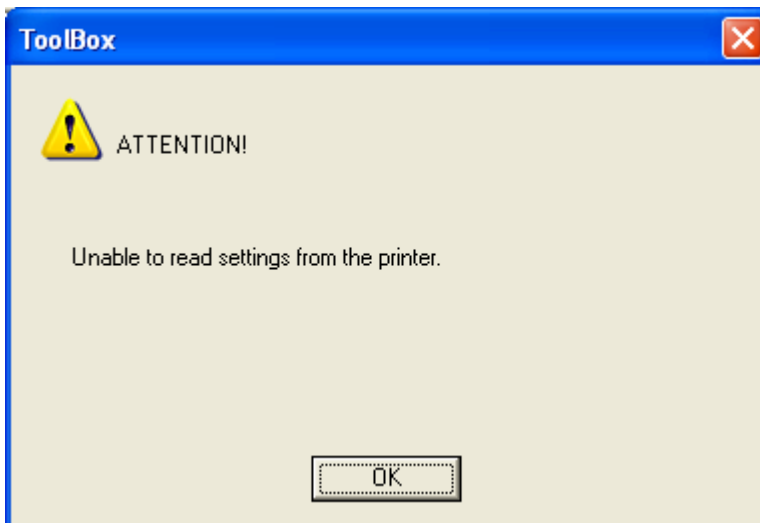

Using the Event Monitoring Group Box

This Event Monitoring group box displays the Low Supplies (Ribbon, Laminate and Film).

- **The default setting is checked.** If checked, the Ribbon Low message box is displayed with every print job when Printer reports low Ribbon to the Driver.
- **Do not show this message again:** The check box allows the User to suppress message per Driver instance. Default = unchecked.

Reviewing the Ribbon Low message

Display – Ribbon Low dialog

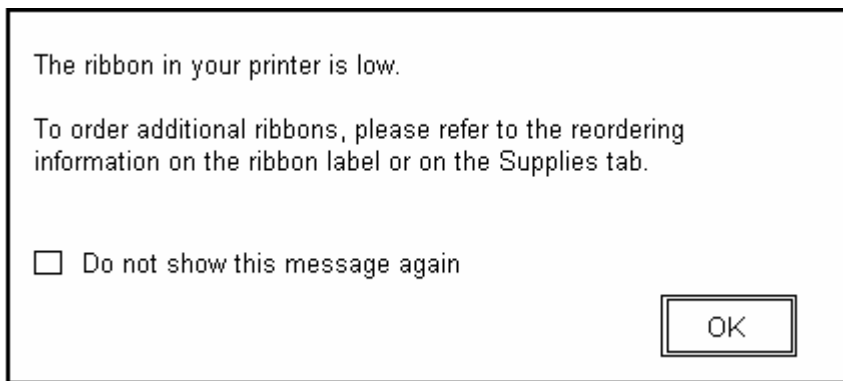

Reviewing the Laminate Low Message

The default setting is checked.

- If checked, Lamination Low message box is displayed with every print job when Printer reports low Ribbon to the Driver.
- **Do not show this message again.** The check box allows User to suppress message per Driver instance. Default = unchecked.

Display – Laminate Low dialog

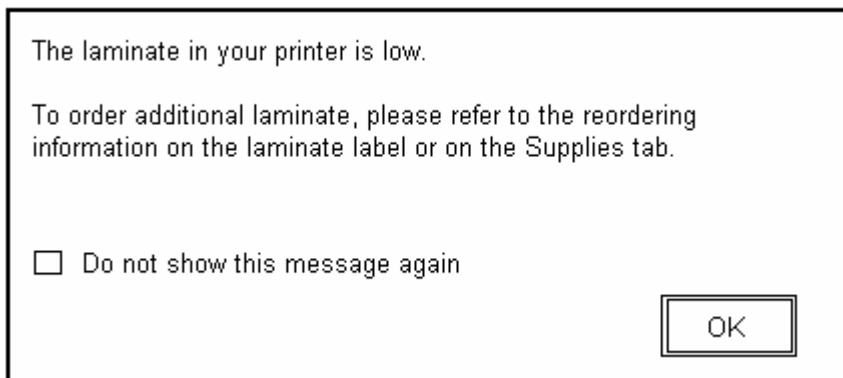

Using the Film Low message

The default setting is checked.

- If checked, Film Low message box is displayed with every print job when Printer reports low Ribbon to the Driver.
- **Do not show this message again.** The check box allows the User to suppress message per Driver instance. Default = unchecked.

Display – Film Low dialog

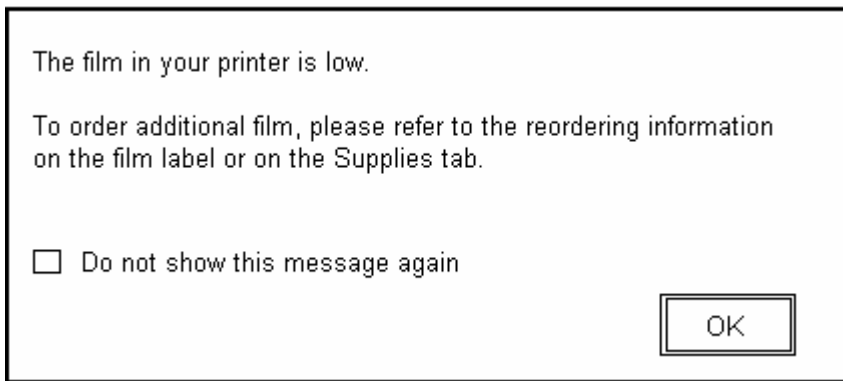

Selecting the Set Language for Printer LCD Display Group Box

The LCD Language can be chosen or changed from the Driver during installation, from the Driver Toolbox Configuration tab or directly from the LCD. The last language chosen from any of these methods is the active language for the LCD.

- English is the default.
- Languages (available in drop down list) are the languages available in the language set (currently resident in the Firmware).

Selecting the Calibrate Laminator tab

The Calibrate Laminator tab is active when the Laminator is automatically detected or when the Laminator is manually checked (as a Printer Feature on the Configuration tab). If the Laminator is not detected and not manually checked, the tab is active; however, all functions are grayed out.

- **Calibrate button:** Sends calibrate Laminator command to Printer. Follow the instruction on the page for setting up the Printer.
- **Help button:** Launches help specific to this tab.

Step	Procedure
1	<p>Select the Calibrate Laminator tab.</p> <ol style="list-style-type: none"> Ensure that the Cartridges are out of the Laminator. Ensure the Laminator Cover is closed. Click on the Calibrate button. (Note: The Printer's LCD will display CALIBRATE PASSED. Error Message Calibration Failed may be solved by manually increasing the sensor calibration number to 13 or higher under the Advanced Settings tab. Do not use the AUTO calibrate function) Click on the OK button on the LCD display to complete the procedure.

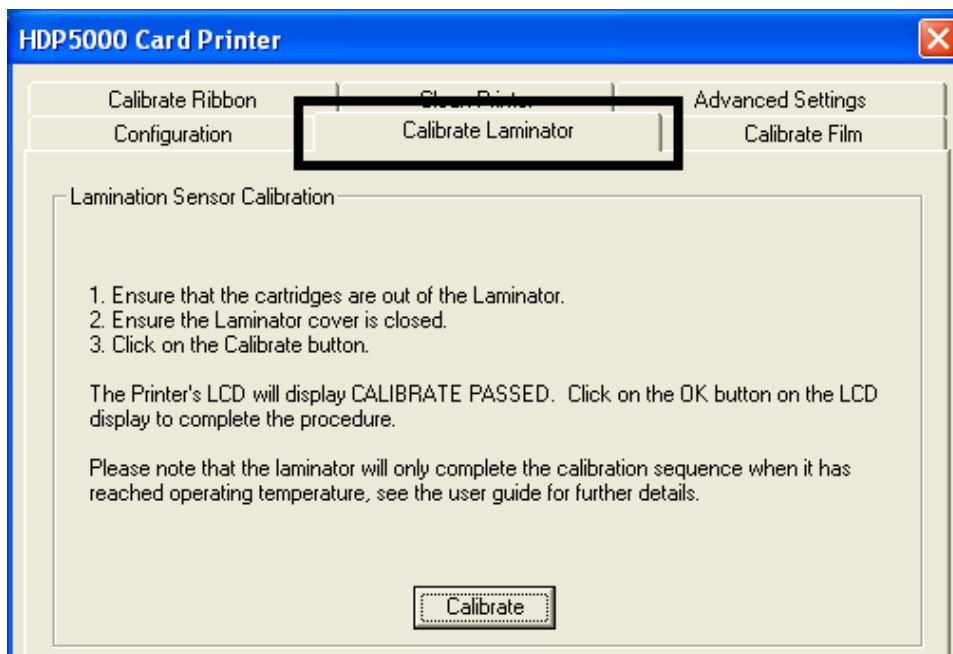

Selecting the Calibrate Film tab

The two buttons for the Calibrate Film tab are described below.

- **Calibrate button:** Sends calibrate film command to Printer. Follow the instruction on the page for setting up the Printer.
- **Help button:** Launches help specific to this tab.

Step	Procedure
1	Select the Calibrate Film tab. <ol style="list-style-type: none"> Ensure that the Film Cartridge is installed. Ensure the Printer's Cover is closed. Click on the Calibrate button. (Note: The Printer's LCD will display CALIBRATE PASSED.) Click on the OK button on the LCD display to complete the procedure.

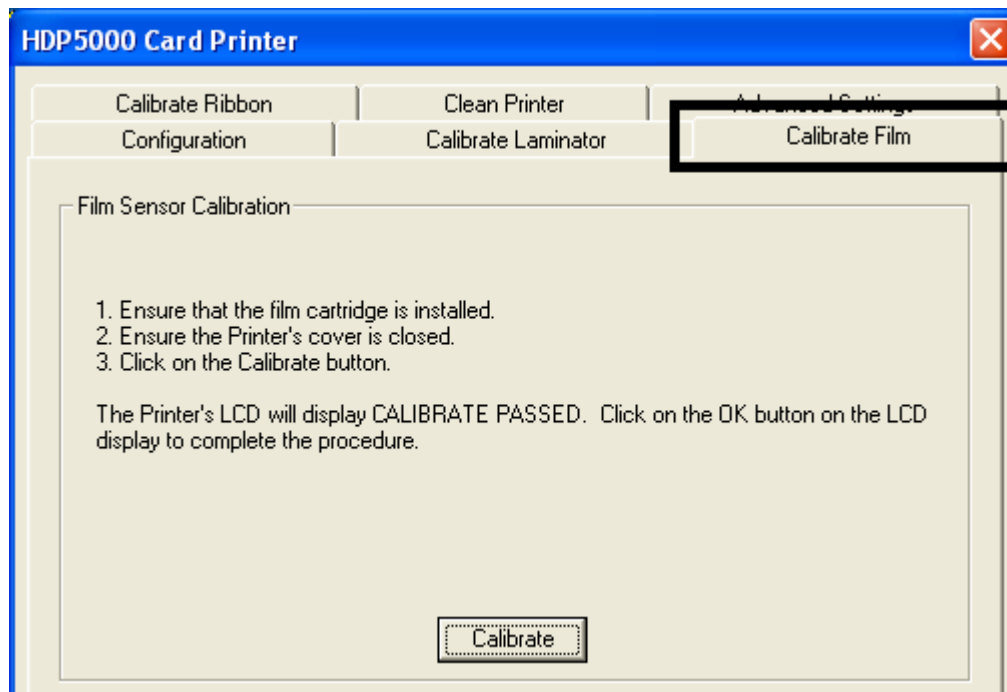

Selecting the Calibrate Ribbon tab

The two buttons for the Calibrate Ribbon tab are described below.

- **Calibrate button:** Sends the Calibrate Ribbon Command to Printer. Follow the instructions below to set up the Printer.
- **Help button:** Launches help specific to this tab.

Step	Procedure
1	<p>Select the Calibrate Ribbon tab.</p> <ol style="list-style-type: none"> Ensure that the Ribbon Cartridge is removed. Ensure the Printer's Cover is closed. Click on the Calibrate button. (Note: The Printer's LCD will display CALIBRATE PASSED.) Click on the OK button on the LCD display to complete the procedure.

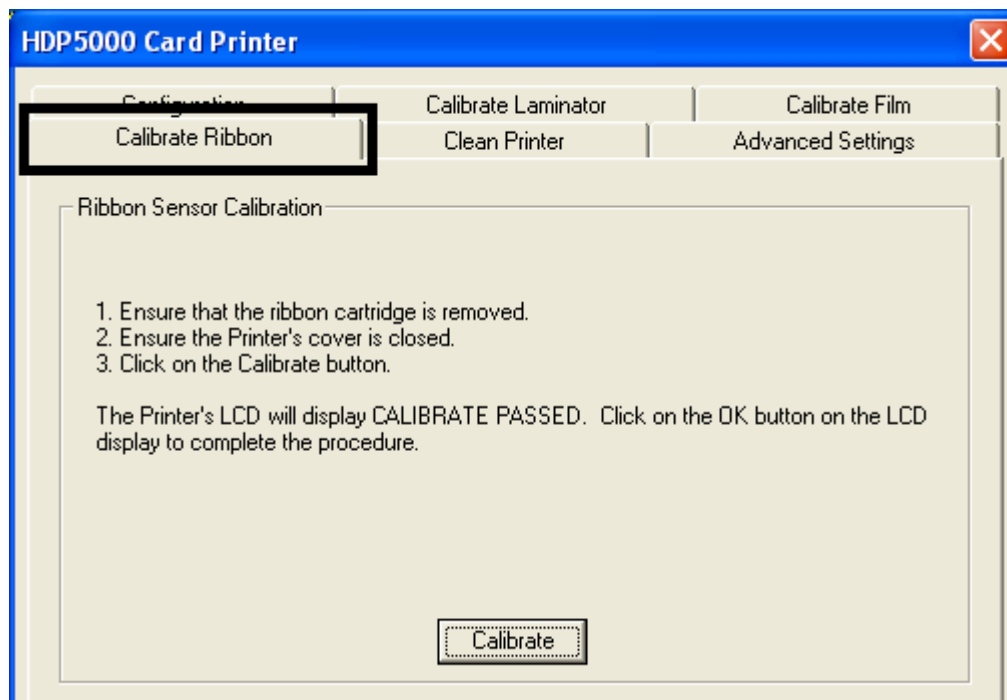

Selecting the Clean Printer tab

The button for the Clean Printer tab is described below.

- **Clean Button:** Launches cleaning routine. Follow the instruction on the page for setting up the Printer.
- **Help button:** Launches help that is specific to this tab.

Step	Procedure
1	<p>Click the Clean Printer tab. See the next page.</p> <ol style="list-style-type: none"> Remove the Card, Film and Laminate Cartridges and close the covers. Remove the paper back from both sides of the Cleaning Card. (Note: DO NOT remove the left liner if a Magnetic Encoding Module is installed in your printer.) Insert the Cleaning Card into the Card Hopper's Infeed Rollers. Click on the Clean button below. Guide the Cleaning Card into the Printer as needed. When the Cleaning routine is complete, the Cleaning Card will exit the Printer. Reinstall the Card, Film and Laminate Cartridges. <p>The Cleaning routine will begin after all current print jobs have completed.</p>

Selecting the Clean Printer tab

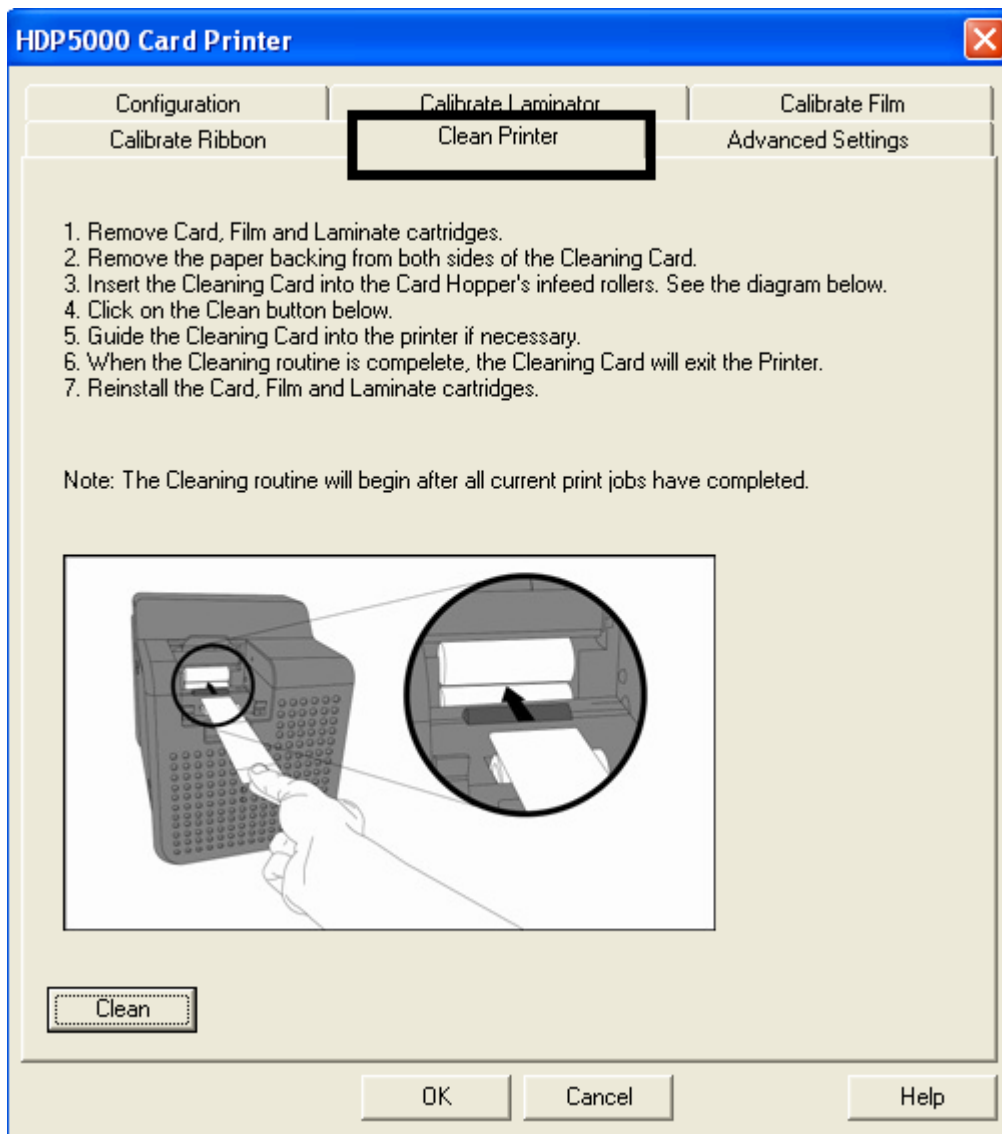

Using the Clean Printer Group Box

The default setting is checked. If checked, **Printer Cleaning Notification** dialog box is displayed when Firmware EE setting changes after 3000 cards. (**Note:** Firmware EE setting resets upon clean command being sent to the Firmware.)

- **Clean Now radio button:** This is the default every time this message box launches.
- **Clean Now radio button:** When this is chosen (and click **OK**), the **Toolbox** is launched open to **Clean Printer** tab.
- **Remind Me radio dial:** This activates a drop down for the User to choose a number of cards to print until the next reminder. If the User chooses **Never**, then the **Clean Printer** notification is cleared from **Configuration** tab. (**Note:** This is because IF the **Clean Printer** notification is checked, the User might believe that the reminder is working while **Never** means the reminder will never be displayed.)
- **OK button:** Use this button to close the dialog box and execute the User choice.
- **Cancel button:** Use this button to close the dialog box with no changes to the state of Printer setting. If the User exits the Toolbox without clicking **Clean**, then the Printer Cleaning Reminder dialog box will reappear on the next print.

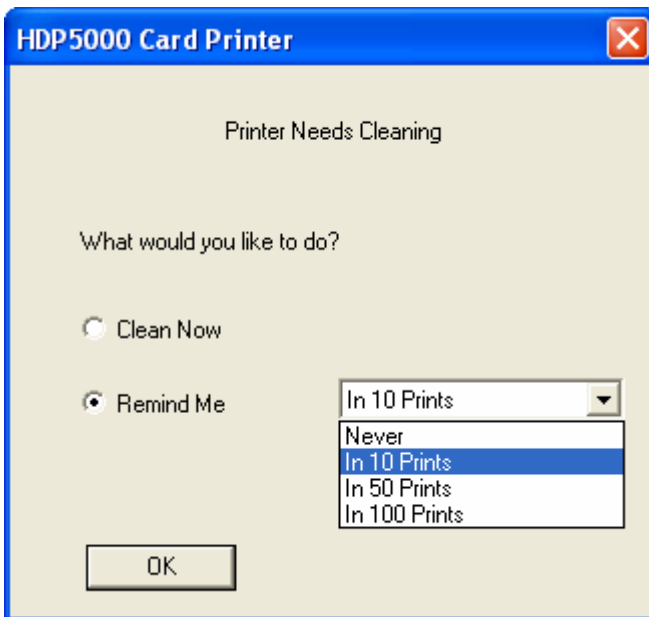

Selecting the Advanced Settings tab

Use the **Advanced Settings** tab for adjusting the internal Printer settings, which are customized for every Printer at the factory and saved directly within the Printer's memory. (**Note:** You can select the Restore Defaults to restore the internal default settings.)

Selecting the Advanced Settings tab

These change values for Firmware settings. See below.

- **Setting Column:** Displays label for setting
- **Default Column:** Displays default value for setting
- **Current Column:** Displays current value for setting
- Change the value by clicking on the value to activate spin control or type.
- **Apply Button:** Applies changed values.
- **Restore Defaults Button:** Restores default values.

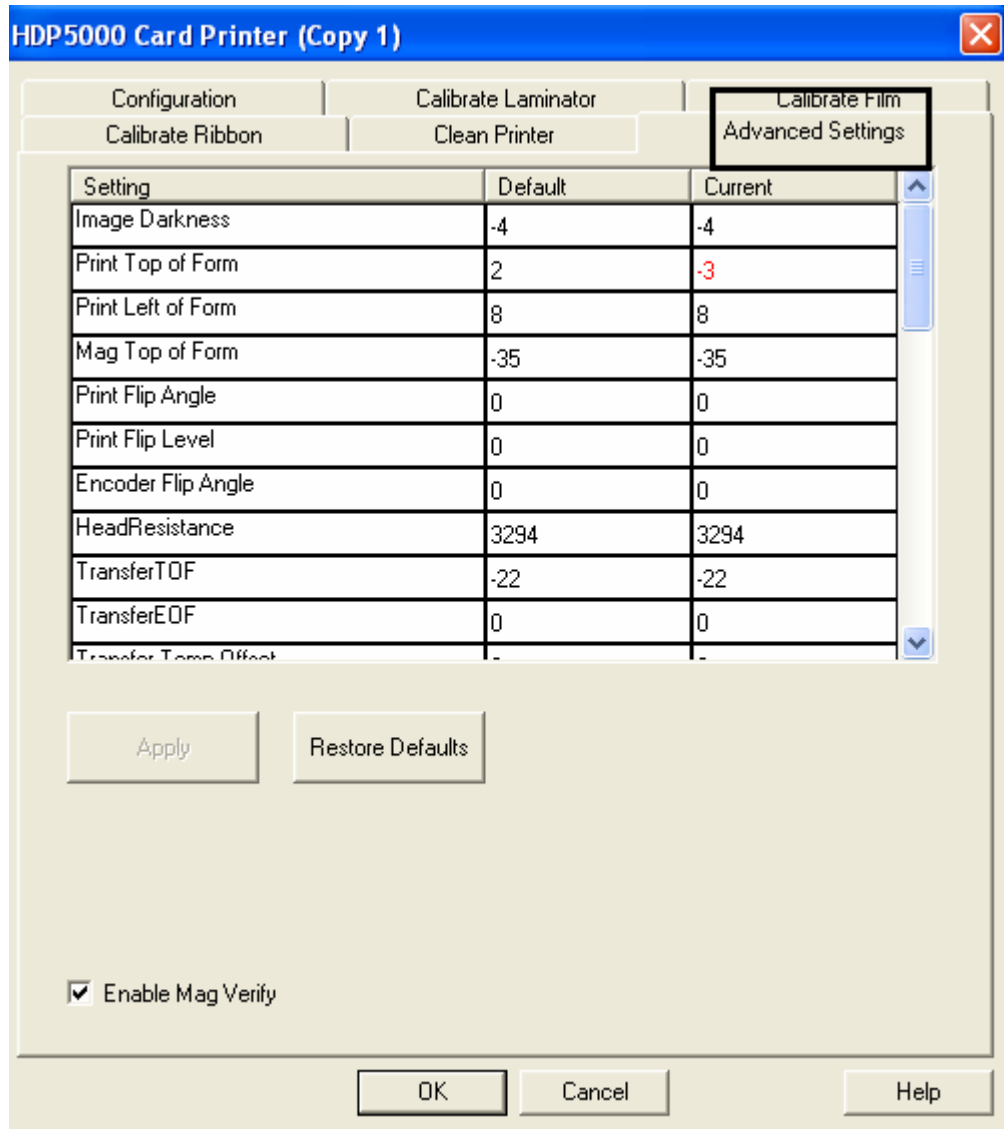

Using the Image Darkness Option

Use this option to set the overall darkness of the printed image by increasing or decreasing the amount of heat used by the Printhead when printing.

Step	Procedure
1	<p>Lighten the printed image by clicking the down arrow ▼ to enter a negative value and decrease the amount of Printhead heat.</p> <p>OR</p> <p>Darken the image by clicking the up arrow ▲ to enter a positive value and increase the amount of Printhead heat.</p> <p> Caution: If the value is set too high, the Ribbon may jam or even break.</p>



Using the Print Top of Form Option

Follow these instructions:

Step	Procedure
1	Verify the Transfer TOF is set to +35.
2	Verify the Print TOF is set to +20.
3	Verify the Print LOF is set to +7.
4	Print the alignment card self-test (The front edge should look like Figure below).
5	Adjust the Print TOF until the green border is eliminated and the entire Transfer Alignment Block is shown in the center of the card. Note – due to variation in roller alignment, the green border may appear at a slight angle on the top of the card.

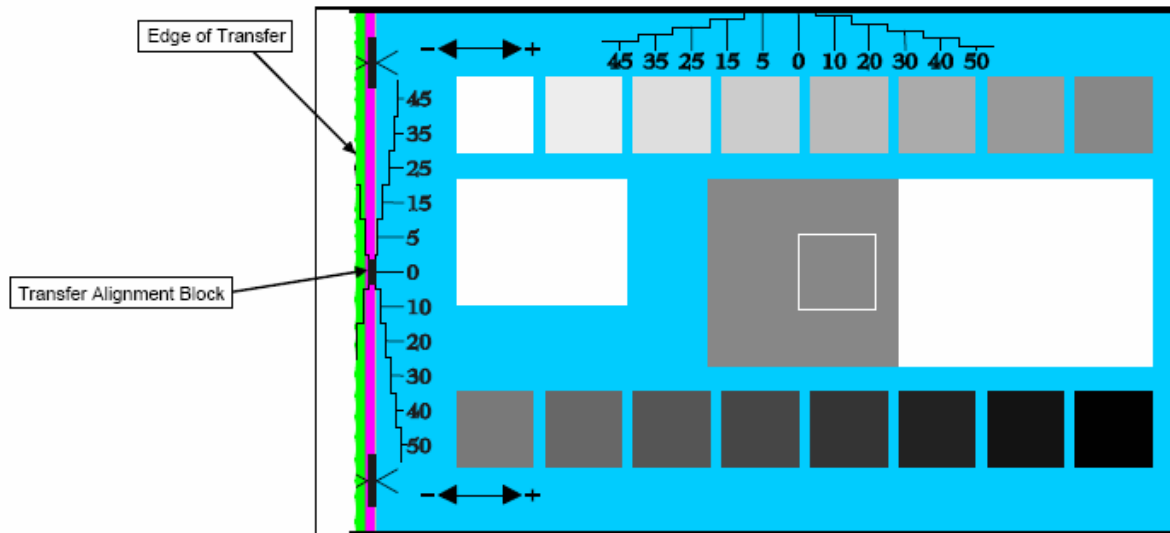

Using the Print Top of Form Option

Step	Procedure
6	Verify: The entire alignment block is visible and the green has been eliminated from the center of the card.

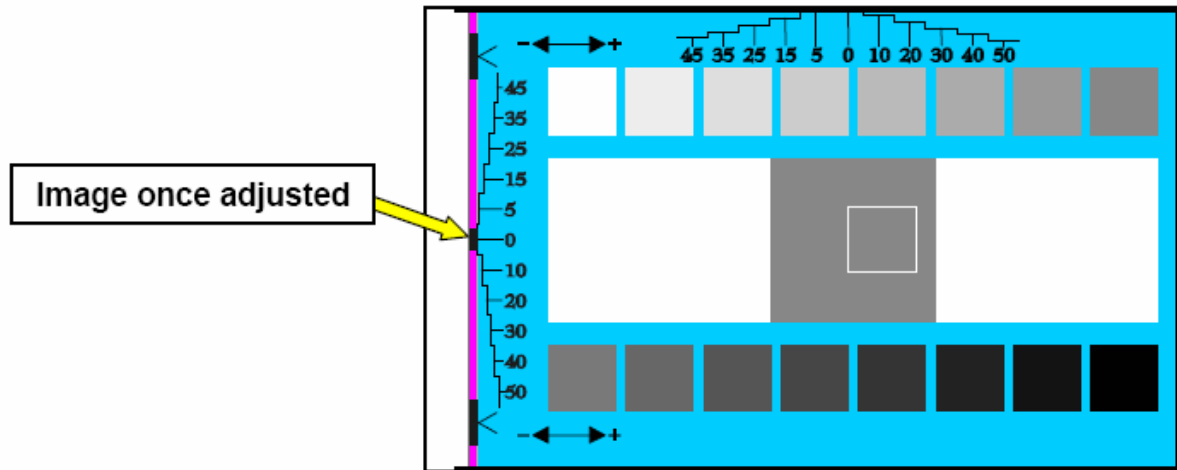

Using the Print Left of Form Option

Follow this instruction.

Step	Procedure
1	Print the Alignment Card Self-test.
2	Adjust the Print LOF up or down until the border of the LOF Zero Line is showing on the edge of the card as shown below.
3	<ol style="list-style-type: none"> Measure the density square, as shown below. Adjust the image density to $66\% \pm 1\%$.

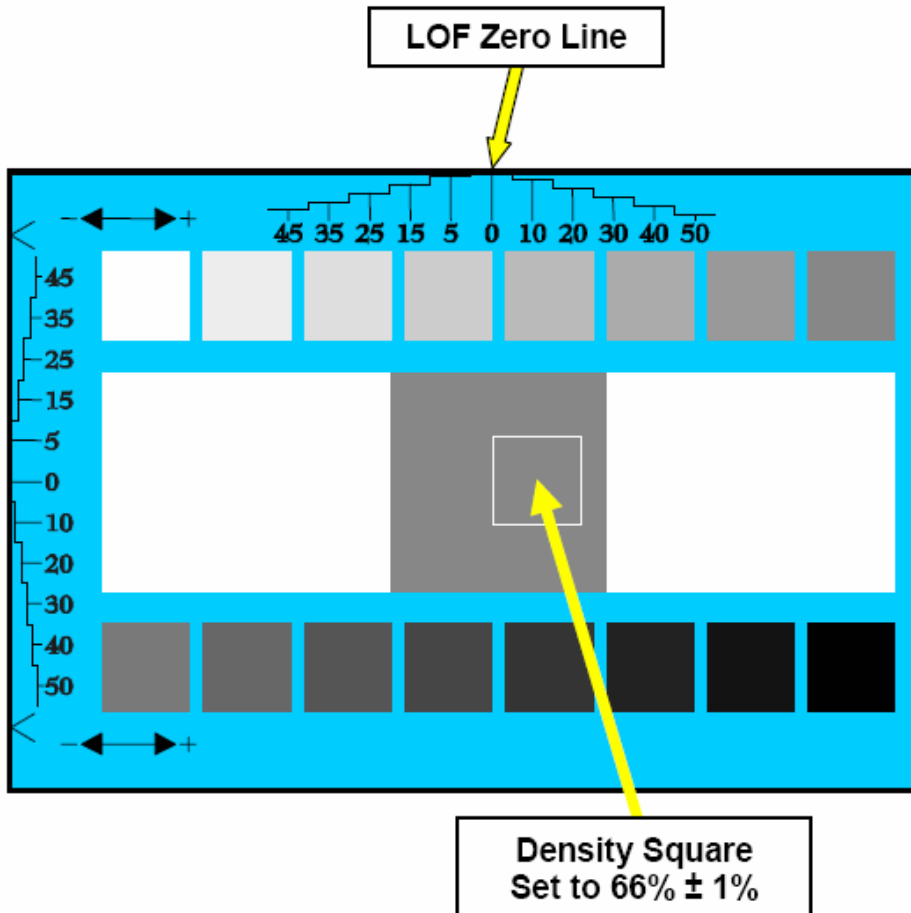

Using the Mag Top of Form Option

Use this option only if the Printer has a built-in Magnetic Stripe Encoder.

- If so, use this option to shift the starting point of where the Printer will begin encoding the magnetic track data on a card's Magnetic Stripe.
- When adjusting this value, keep in mind that a card and its Magnetic Stripe will always remain in the same relative position as the card travels through the Printer.

The diagram (below) represents:

- How the magnetic data will move in relation to the fixed position of a card's Magnetic Stripe as a "positive" or "negative" Magnetic Offset value is entered.
- For this diagram, assume that the card is transparent and the card's Magnetic stripe can be seen through the top or front side of the card.

Step	Procedure
1	<p>Enter a negative value to move the start of the magnetic data more toward the leading edge of the card or the card output side of the Printer.</p> <p>OR</p> <p>Enter a positive value to move the start of the magnetic data toward the trailing edge of the card or the card input side of the Printer.</p> <ul style="list-style-type: none"> • Magnetic Data Direction: The arrows on these buttons indicate the direction the magnetic data will move on the card's Magnetic Stripe. • Maximum Adjustment Range: The maximum adjustment range is ± 99. As a rule, 20 equals about .030"/. 8mm.) (Note: Keep this in mind when adjusting this option to avoid over-adjusting.) <p> Caution: If the negative value is set too high, the Printer may start encoding before the card's Magnetic Stripe reaches the encoding head.</p>

Using the Mag Top of Form Option

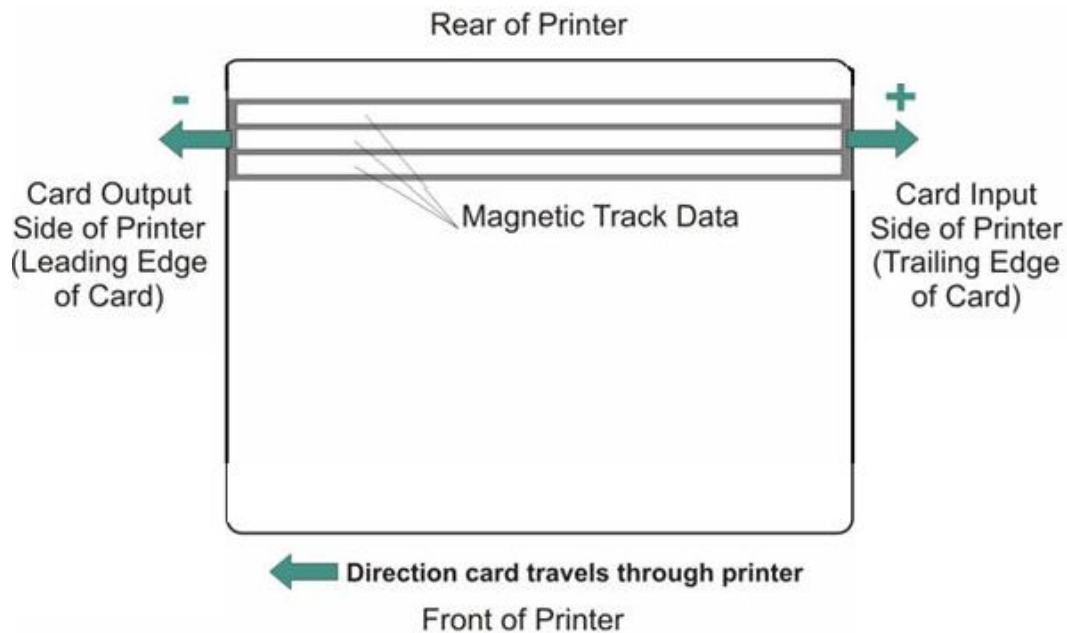

Using the Print Flip Angle Option

Use the **Print Flip Angle** option to set the position of the Flipper so it is level with the card path after a flip operation.

Using the Print Flip Level Option

Use the **Print Flip Level** option to set the position of the Flipper so it is level with the card path.

Using the Encoder Flip Angle Option

Use the **Encoder Flip Angle** option to fine tune the position of the Flipper. (**Note:** This is done in relation to the Printer's built-in Encoder if your Printer is equipped with this option.)

Setting the Printhead Resistance

This is factory set. If the main board or the Printhead is replaced then adjust this number.

- Locate the Printhead Setting Number on the bottom of the Printhead.
- The number reads R=XXXX.

Using the Transfer TOF Adjustment Option

Follow this instruction.

Step	Procedure
1	Print the alignment card self-test.
2	Adjust the Transfer TOF until the TOF Zero Line is located on the edge of the card as shown below.

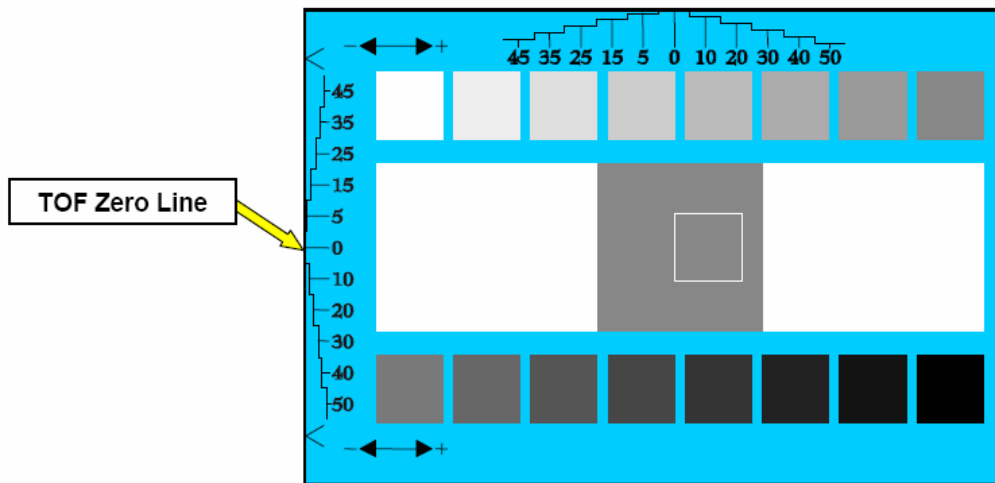

Using the Transfer TOF Adjustment Option

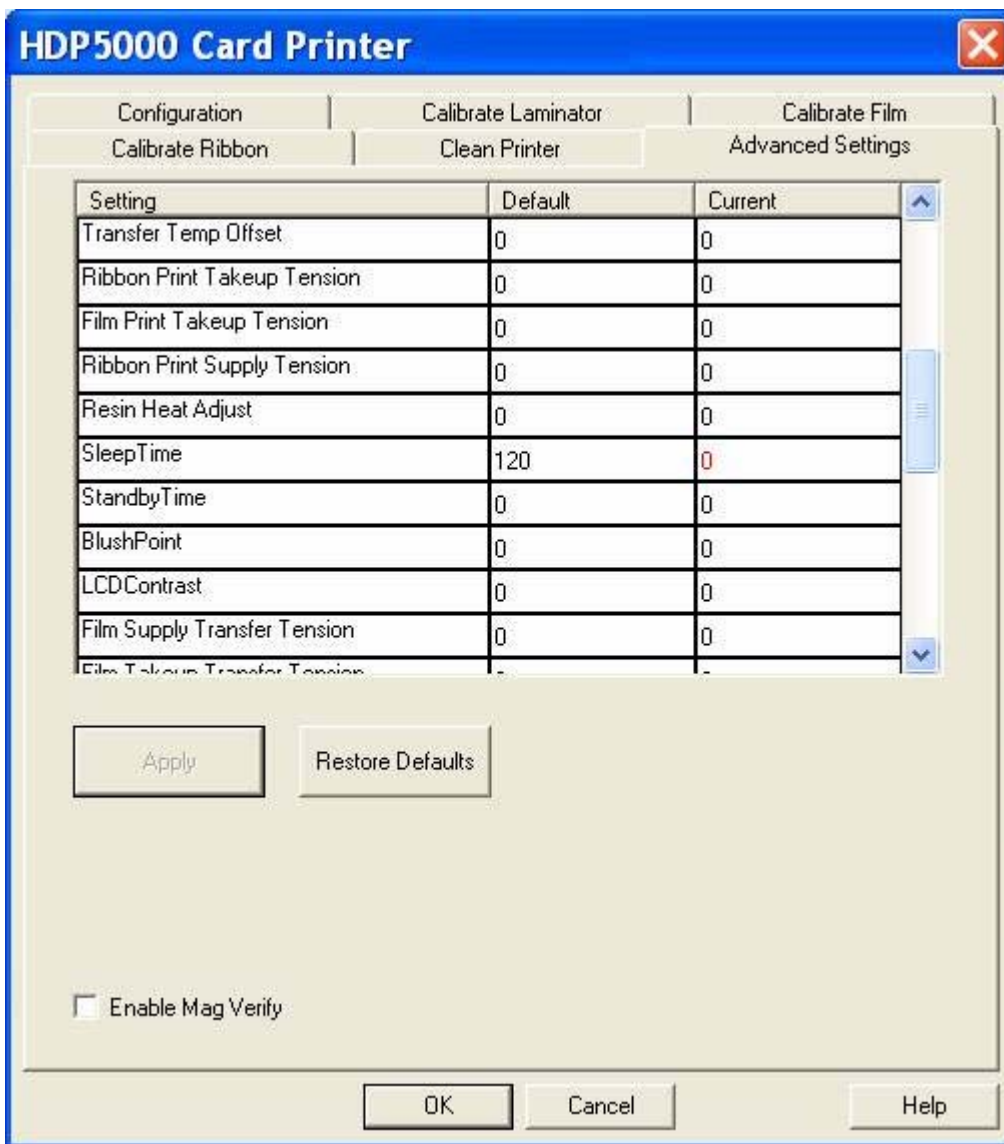

Using the Transfer Temp Offset Option

This option adds an offset to the temp the printer is reading from the transfer roller. (**Note:** This setting should be used only make the temp of the transfer roller and the goal on LCD match.)

- Use the slider on “Image Transfer” tab to make adjustment for card stock. (**Note:** A “-” Adjustment will increase the actual temp of roller.)

Using the Ribbon Print Takeup Tension Option

This procedure controls the tension of the color Ribbon during printing.

- Adjust the Ribbon tension if the Ribbon wrinkle is appearing on the card. (**Note:** Adjustments moderately change the image length.)

Using the Film Print Takeup Tension Option

Caution: The Film Drive sets the baseline for the Film Tension and should not be adjusted by the reseller or the end User.

- Adjustments moderately change the image length.)

Using the Ribbon Print Supply Tension Option

This procedure controls the tension of the color Ribbon during printing. Adjust the Ribbon tension if the Ribbon wrinkle is appearing on the card. (**Note:** Adjustments moderately change the image length. “+” Adjustments can eliminate some cases of wrinkle.)

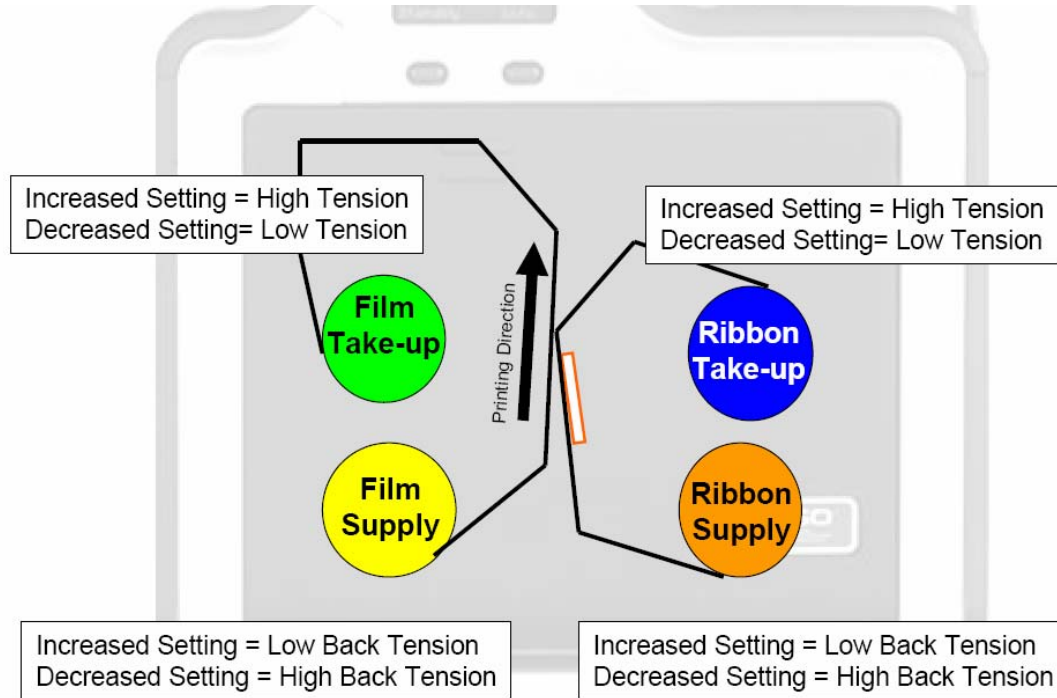

Using the Film Supply Transfer Tension Option

Adjustments significantly change image length. Only small adjustments recommended because of sensitivity. (**Note:** Adjustments affect flash and smudge.)

Using the Film Takeup Transfer Tension Option

“-” Adjustments can cause card jams. (**Note:** “+” Adjustments can help stop jamming. Adjustments affect flash and smudge.)

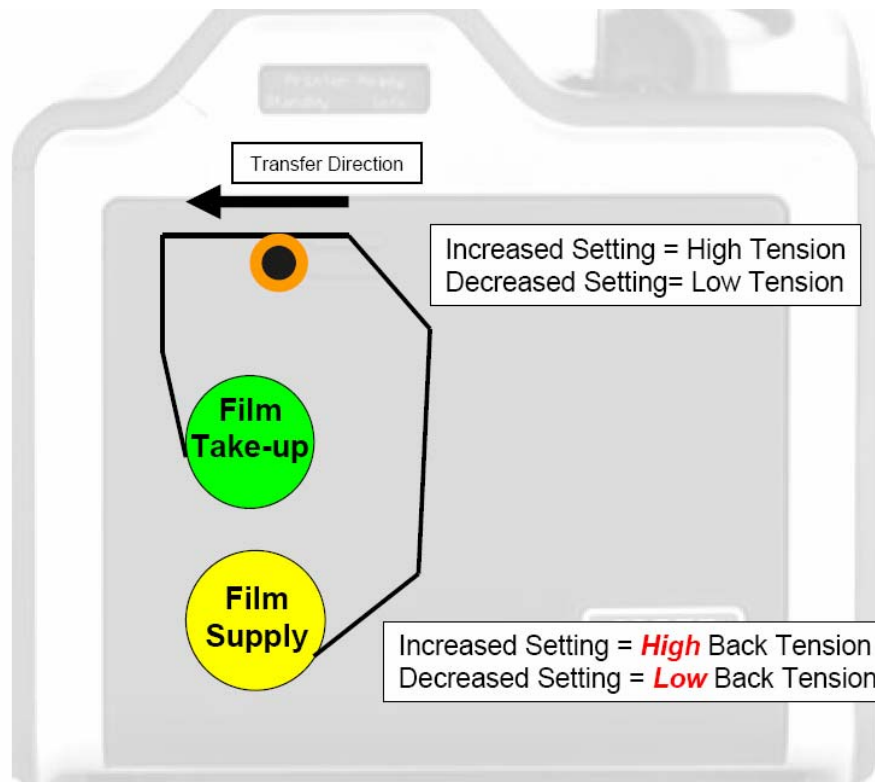

Using the Resin Heat Adjust Option

Use this adjustment for Black resin text and barcodes appear faded or too light/dark.

Using the Sleep Time Option

This setting adjusts the time until printer stops energizing the transfer roller conserve energy. A setting of "0" will disable. (**Note:** The counter for this setting starts after Standby Time has elapsed.)

Using the Standby Time Option

This setting adjusts the time until printer goes into a reduced transfer roller temp to conserve energy. (**Note:** A setting of "0" will disable. Settings are in minutes.)

Using the Blush Point Option

The blush point is compensation during printing:

- There is no dye transfer.
- There is no a light gray line on a portion of the card.
- It should be white.

Using the LCD Contrast Option

Use this setting to adjust the brightness of the LCD panel.

Using the Cleaning rate Option

The message to clean the printer uses a defaulted number of passes of 3000 and to change this click up or down one number per one card.

Using the EAT Disable Option

This is an **ON** or **OFF** switch. 0 is off and 1 is on. This will tell the printer to keep track of the environmental temperature and compensate for it.

“Environmentally Adaptive Transfer” automatically adjusts the transfer temp based on the ambient air conditions within the printer. Will increase or decrease the transfer roller temp by as much as 20C in extreme conditions.

This mode defaults to on and a setting of “1” will disable.

Using the Film Print Cooling Level Option

This controls the speed of the transfer roller cooling fan during the printing process.

This setting should normally be off, but can be turned on to help with splotchy color areas on the image. Too high fan speed can cause smudge.

Using the Film Transfer Cooling Level Option

This controls the default speed of the cooling fan for the transfer process.

Adjusts fan speeds and on times during transferring. This setting affects both flash and smudge.

Using the Enable Ribbon Wrinkle Compensation Option

This is an on or off switch. When this is enabled it will turn on extra pixels on the printhead to help with ribbon wrinkle during the print process.

Using the Holo Transfer Offset Option

This option changes the Hologram Overlamine Offset for placement parameters.

Using the Standby Temp Option

This option changes the temperature used when the printer is in standby mode.

Using the Mag Hi-Co Voltage Offset Option

This option changes the voltage going the magnetic head.

This is factory set and should not be changed unless directed by a technician.

Using the Mag Lo-Co Voltage Offset Option

This option changes the voltage going the magnetic head.

This is factory set and should not be changed unless directed by a technician.

Using the Mag Flipper Angle Offset Option

This option changes the angle of the Flipper Table. Increasing the flipper angle will rotate the flipper table clockwise. This is factory set and should not be changed unless directed by a technician.

Using the Lamination Top of Form Option

This option changes location of patch(s) over length of card

Using the Lamination End of Form Option

This option changes head lift at end of card

Using the Lamination Bottom Takeup Option

This option changes tension of Laminate roll 1.

Using the Lamination Top Takeup Option

This option changes tension of Laminate rolls 2 (if equipped)

Using the Lamination Card Backup Option

This option changes distance card backs up after lam pressure is first applied

Using the lamination Card Length Option

This option dictates length of card (should not be adjusted)

Reviewing the No Printer Connected error message

If there is no Printer connected or if the Driver is unable to communicate with the Printer, the following error will be displayed and the grid will be blank.



Reviewing the Value outside the Range error message

If typing a value outside the range, an error message will display specific to the setting when leaving the spin control to click any other spin control, button or tab.

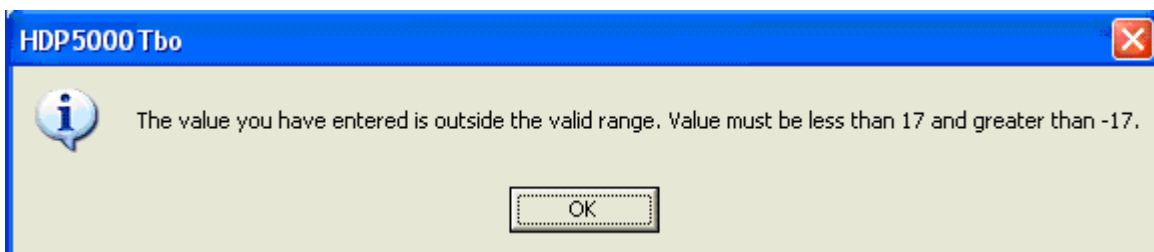

Section 11: Cleaning

HDP5000 Cleaning Kit part number is 089200. For more detailed instruction, please refer to the Cleaning Kit Instruction Sheet in the kit.

Important: The Printer should be cleaned on a regular basis to ensure that the Printer consistently produces high quality output.



Danger: Be sure to disconnect the Printer's power cord whenever performing any type of maintenance procedure unless otherwise directed.

Important: Fargo Card Printers require highly specialized Print Ribbons to function properly. To maximize Printer life, reliability, printed card quality and durability, you must use only Fargo Certified Supplies. For this reason, your Fargo warranty is void, where not prohibited by law, if you use non-Fargo Certified Supplies. To order additional materials, please contact your authorized reseller.

Using the Required Supplies

For the maintenance procedures outlined for the Printer, you will need a Printer Cleaning Kit, available from the reseller. This optional kit includes the following:

- **Printhead Cleaning Swabs** pre-moistened with 99.99% isopropyl alcohol for cleaning the Printer's Printhead.
- **Cleaning Cards** with an adhesive backing for cleaning the Printer's Cleaning Rollers.
- **Gauze Pads** pre-moistened with 99.99% isopropyl alcohol for cleaning the Printer's interior and exterior.
- **Alcohol Cards** pre-moistened with 99.99% isopropyl alcohol for cleaning the Printer's Platen Rollers, Card Feed Rollers.



Caution: As with any electronic device, internal components of the Printer, such as the Printhead, may be damaged if exposed to static electrical discharges. To avoid potential damage, always wear an appropriate personal grounding device, such as a wrist strap (with integral resistor) connected to an ESD ground. At a minimum, make positive contact with the bare metal chassis of the Printer with the hand prior to touching any internal electrical components.

Accessing the Clean Printer tab

Cleaning the Printer Platen Roller and Card Feed Rollers

Perform this procedure approximately every **1,000 prints** to maintain a consistent print quality. (**Note:** The Card Feed Rollers move the card throughout the print process. Rollers should be kept clean to prevent card jams and card contamination. This cleaning process will ultimately lead to better print quality and extended Printhead life.)

Step	Procedure
1	From the HDP5000 Driver, click on the Toolbox button to bring up the Clean Printer tab.
2	Follow the instructions from the CLEAN PRINTER tab on the Driver. See Display A below. (Note: If your Printer is equipped with a Magnetic Encoder, you must insert the Cleaning Card with the printed side up and with a small Liner Strip towards the front of the Printer. See Display B below)
3	Replace the printing supplies and close the Print Stations after the Rollers are clean and completely dry.

Cleaning the Printer Platen Roller and Card Feed Rollers

Display A – Clean Printer window

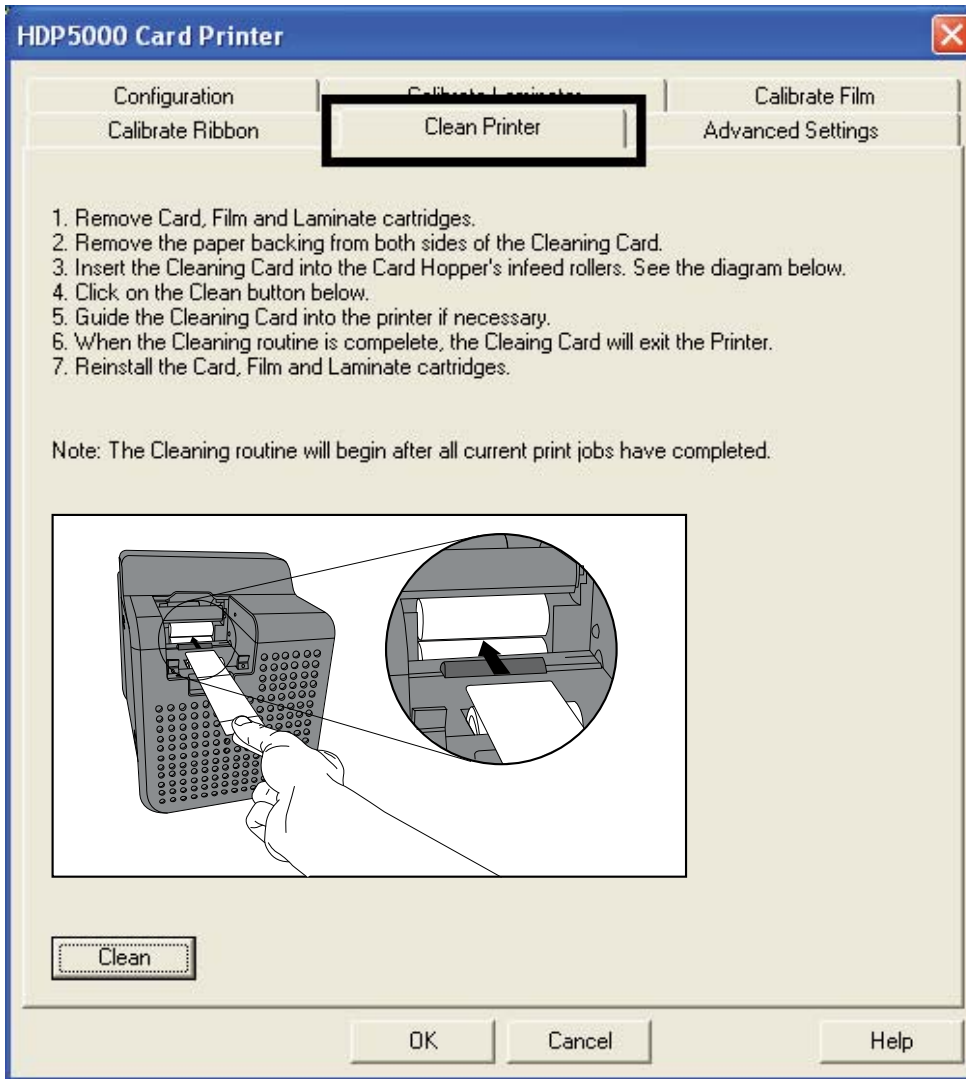

Cleaning the Printer Platen Roller and Card Feed Rollers

Display B - Cleaning Card setup for Magnetic Encoder

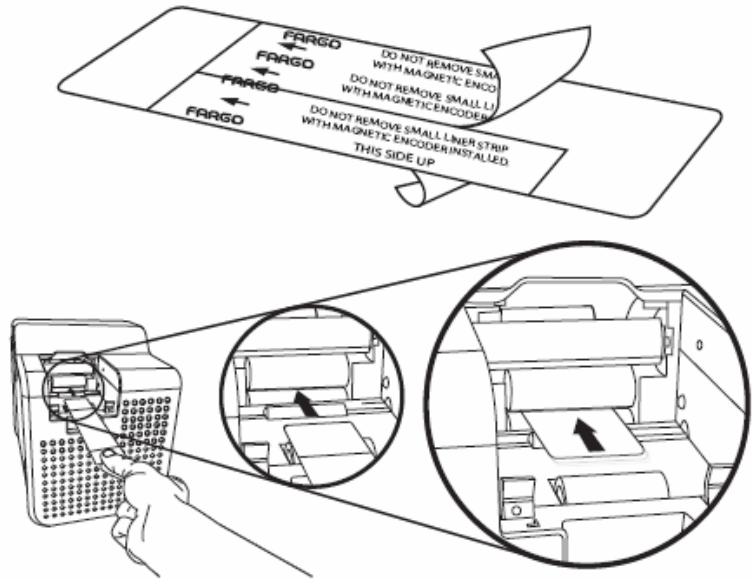

Cleaning inside the Printer

Step	Procedure
1	Open the Front Cover.
2	Remove the Print Ribbon and HDP transfer Film from the Printer.
3	<p>If you have a can of compressed air, blow out all visible areas of the Printer interior. (Note: Remove any debris that may be inside.)</p> <p>OR</p> <p>If you do not have a can of compressed air, use a cleaning pad from the Printer Cleaning Kit to wipe out all visible areas inside the Printer. (Note: Remove any debris that may be inside.)</p> <p> Caution: Be extremely careful not to let any alcohol drip inside the Printer!</p>
4	Re-install the printing supplies.
5	Close the Front Cover.

Cleaning outside the Printer

Step	Procedure
1	<p>The Printer has a durable casing that should retain its luster and appearance for many years.</p> <p>Clean it only with a Cleaning Pad from the Printer Cleaning Kit.</p> <p> Caution: Do not use cleaning solvents of any kind or spray the printer with a cleaner!</p>

Cleaning the Printhead

Clean the Printhead (every time the Print Ribbon is changed) to maintain consistent print quality, as instructed below. This procedure should also be performed approximately every 1000 prints in order to maintain consistent print quality.



Caution: Never use a sharp tool or abrasive object of any kind to clean the Printhead. It will damage the Printhead. Watches, rings, bracelets and other jewelry can damage the Printhead if accidentally bumped against it. For best results, remove such items before touching any internal components of the Printer.

Step	Procedure
1	Remove watches, rings, bracelets and other jewelry.
2	Disconnect the Printer Power Supply and if applicable the Lamination Power Supply.
3	Open the front cover. Remove the Ribbon and Film Cartridges
4	Use a Printhead Cleaning Swab (squeeze to saturate the tip) from the Printer Cleaning Kit to firmly wipe back and forth across the surface of the Printhead. See display below. The printing surface is vertical and faces the left side.
5	Reinstall the cartridges and close the cover once the Printhead is completely dry.



Replacing the Card Cleaning Roller



Caution: Replace the Card Cleaning Tape approximately every time the Print Ribbon is changed.

Steps	Procedure
1	Remove the Card Cartridge to access the Cleaning Roller.
2	Remove the cleaning roller as shown in Display A.
3	Replace with the new Card Cleaning Roller.



Cleaning the Magnetic Encoder

Step	Procedure
1	Open the front cover and remove the Film Cartridge.
2	Remove the Magnetic Cover to access the Magnetic Head.
3	Remove the Magnetic Head. See Display A below.
3	Use an alcohol wipe from the cleaning kit to clean the Magnetic Head. See Display B below.
4	Replace the Magnetic Head and Magnetic Cover.

Display A



Display B

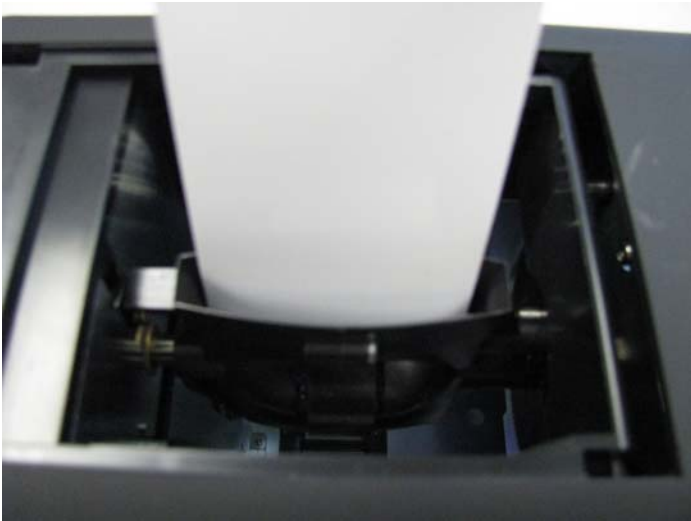

Cleaning the Magnetic Encoder when installed in the Flipper

Step	Procedure
1	Open the top cover of the Flipper Module.
2	Remove the Alcohol saturated Cleaning Card from the wrap.
3	Tilt the Flipper Table so it is UP & Down. The Magnetic Head is located underneath the flipper module.
4	Insert the cleaning card in to the flipper table slot. 
5	Open the printer cover. Use the Forward and Back buttons to move the card back and forth. Turn the card around and perform the task again.
6	Let the Magnetic head dry thoroughly before plugging the printer back in.

Replacing or Cleaning the FAN foam filter

Step	Process
1	Grasp the top of the Inlet Fan Cover and pull OUT then UP to release the tabs holding the bottom of the Inlet Fan Cover .
2	Remove the Foam Fan Filter Insert to replace or clean. Clean with water and be sure the foam is dry before replacing into printer.
3	Replace the Inlet Fan Cover by fitting the bottom tabs in first then clicking the top in place.
4	You have completed this procedure.

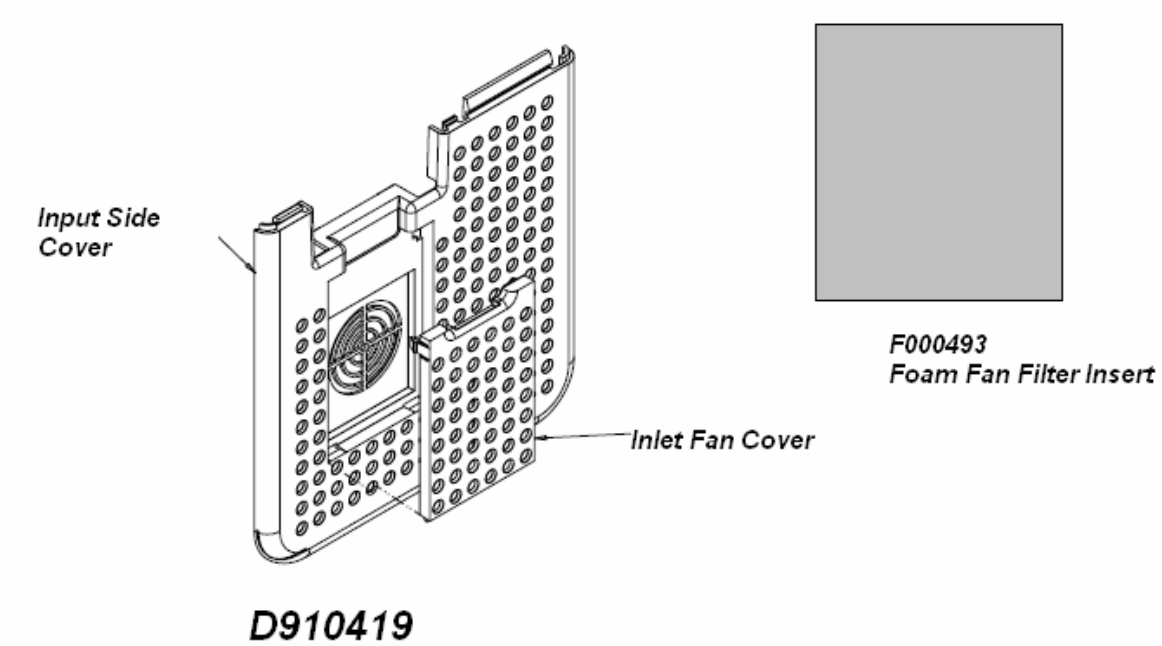

Section 12: Fargo Workbench Printer Utility

Click on **Diagnostics** to bring up the Fargo Workbench Printer Utility. See the **Fargo Workbench Printer Utility Help File** for further instructions on each option.

Reviewing the Card tab and Diagnostic button

Display A – Card tab > **Diagnostics** button

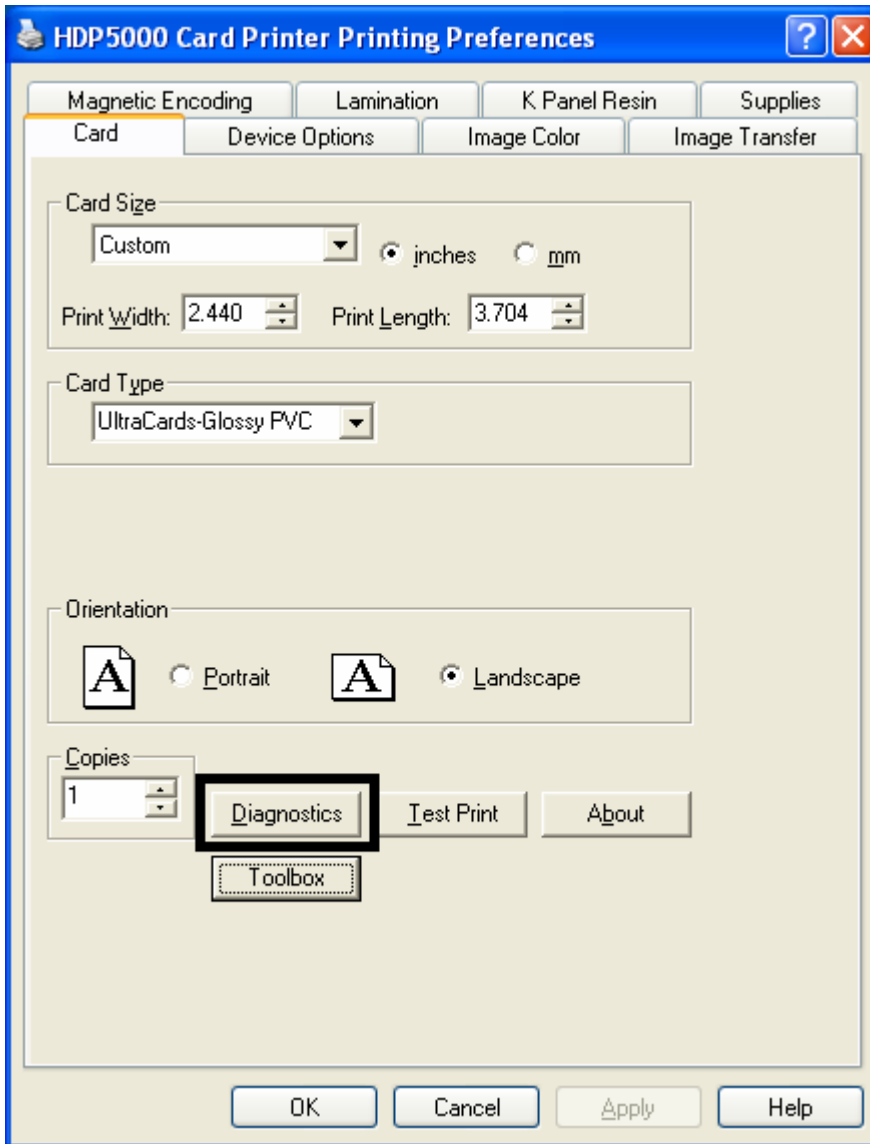

Reviewing the Card tab and Diagnostic button

Display B – Fargo Workbench Printer Utility (see the appropriate User Guide located on your CD)

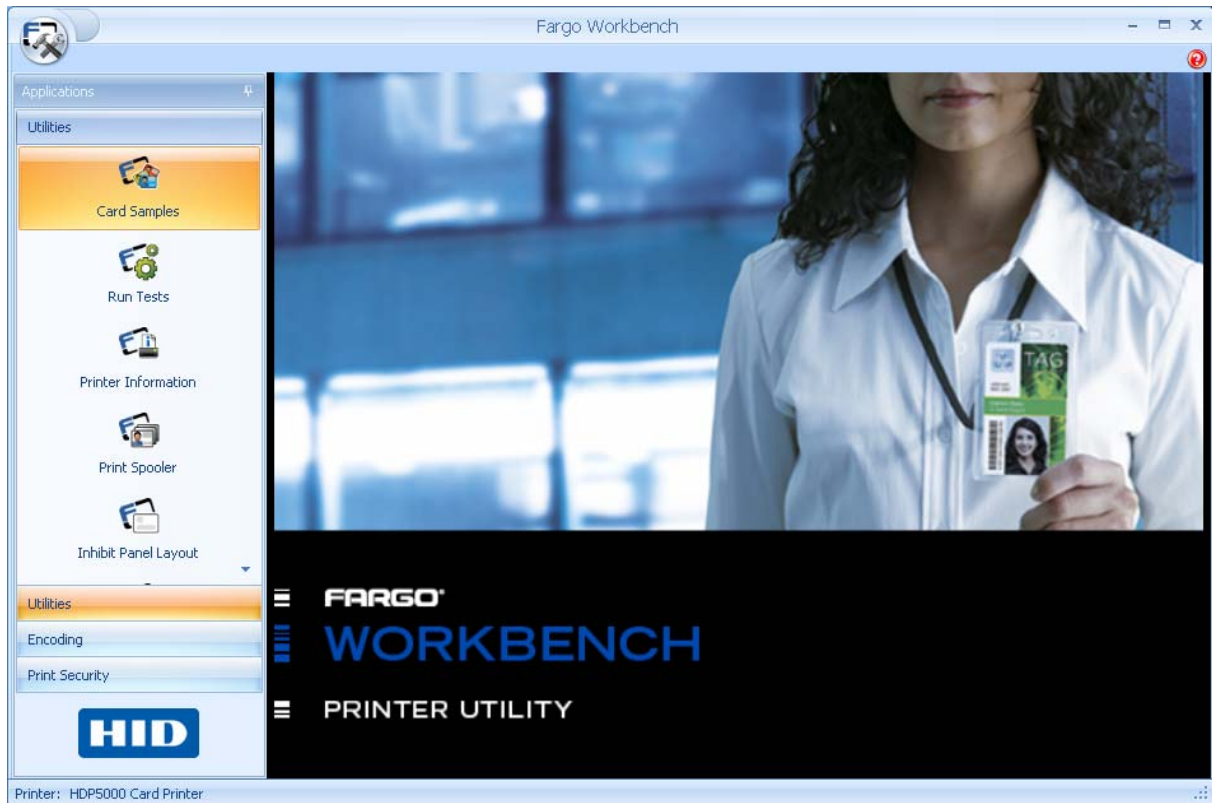

Section 13: Fluorescent Panel Usage

YMCFK Ribbon for HDP5000 is an economical way to add a fully customizable, incremental level of security to your photo identification cards. This process allows the user to configure the data that is printed with the fluorescent panel of an YMCFK Ribbon. **(Note:** Any software program may be used to print the special florescent panel of the Ribbon to a card once the driver and Workbench are set up correctly.)

- These Ribbons contain a yellow (**Y**), magenta (**M**), cyan (**C**), and resin black (**K**) panels to create a full color over-the-edge printing identification card. In addition, the Ribbon contains a dye-based fluorescing panel (**F**) which will allow you to print a standard or one-to-one personalized grayscale fluorescing image that is completely invisible until exposed to ultraviolet light.

There are two (2) methods used to accomplish the creation of a custom fluorescent image when using the YMCFK Ribbon for the HDP5000.

- The first method (described below) uses the Fargo Workbench Printer Utility to create a static image that will be applied automatically to each card sent to the printer.

- The second method (described later in this document) allows the creation of the fluorescent panel image directly from the badge application software. (**Note:** This enables the user to print a unique fluorescent image, such as the card holder's picture, on each card.)

Configuring Fluorescent Data (F-Panel for YMCFK Ribbon) using the Workbench

Step	Procedure
1	From the Driver Printing Preferences, click on Diagnostics to bring up the Fargo Workbench Printer Utility.
2	<ol style="list-style-type: none"> Click the Print Security applet group and select the Security Imaging applet. Check the Enable Secure Imaging Checkbox. (Note: The option for both front and back are set up the same way.)

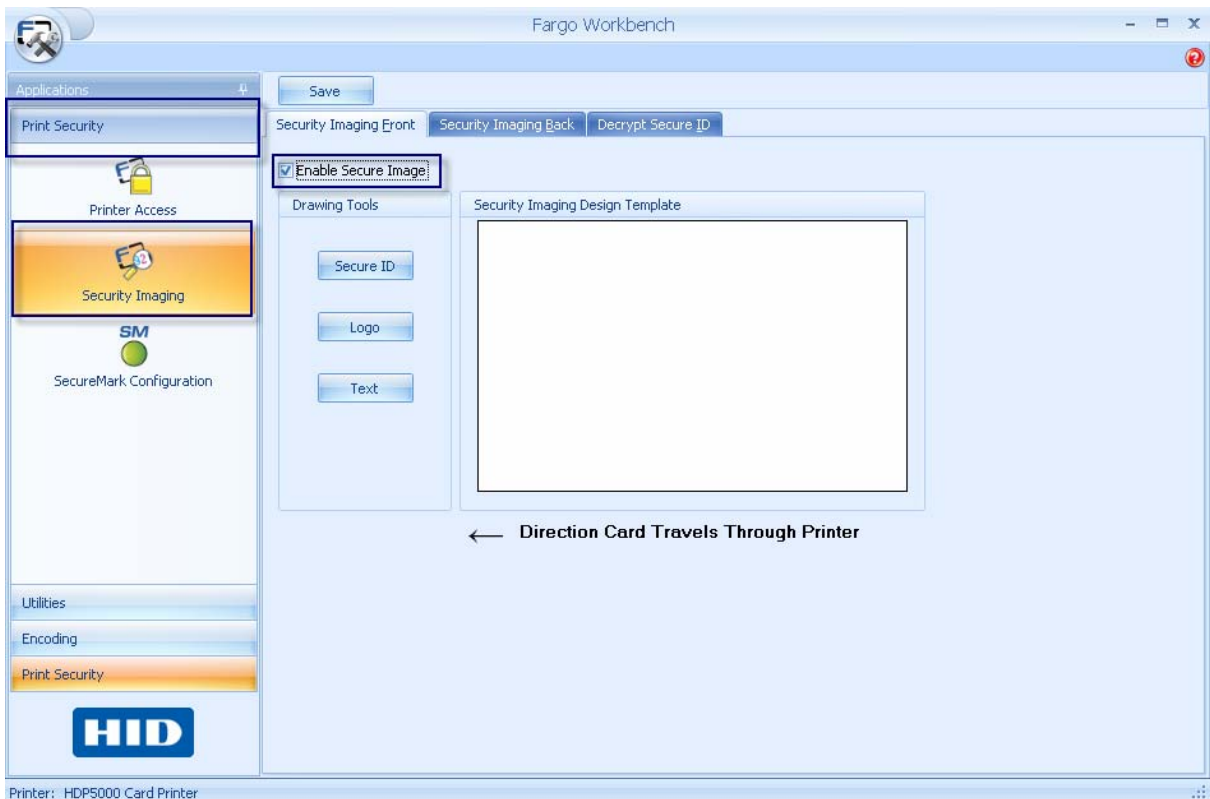

Configuring Fluorescent Data (F-Panel for YMCFK Ribbon) using the Workbench

Step	Procedure
3	<ol style="list-style-type: none"> a. Click on the Secure ID box on the left. b. Click and drag a box onto the Template. c. Move and size as needed.

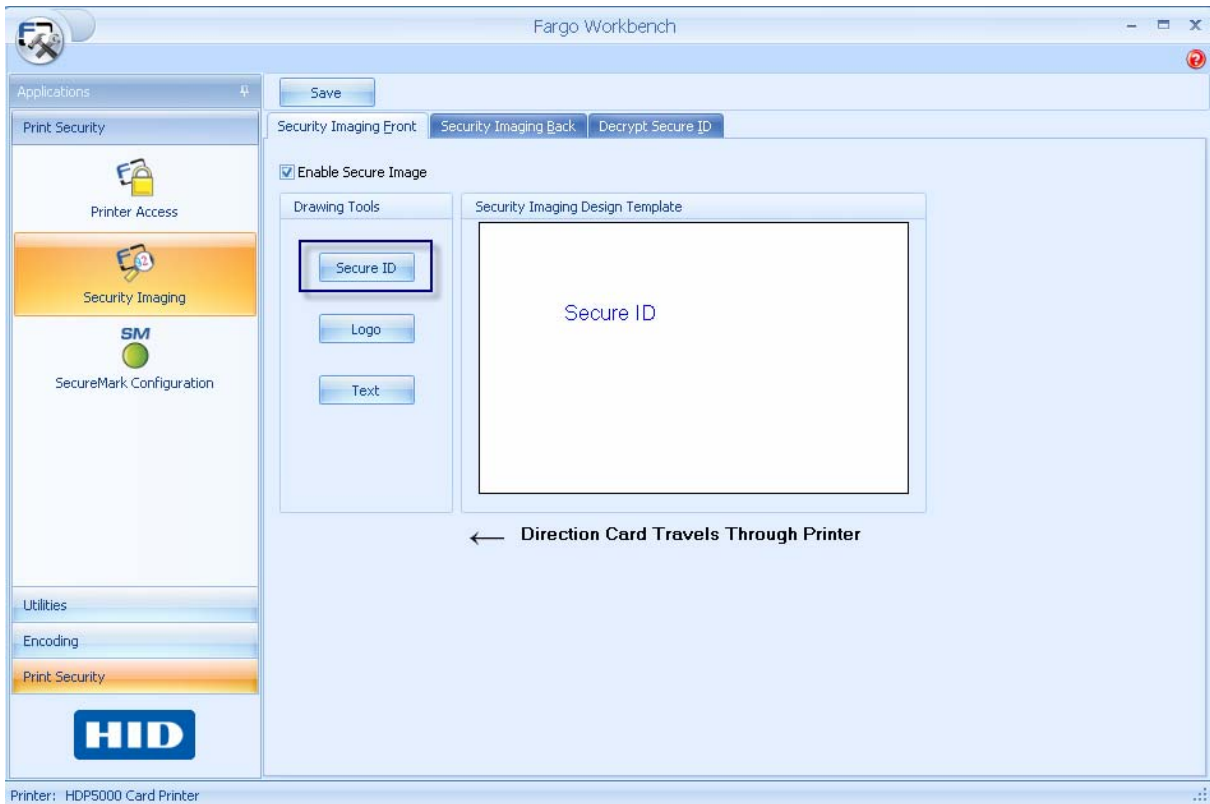

Configuring Fluorescent Data (F-Panel for YMCFK Ribbon) using the Workbench

Step	Procedure
4	On the Template, right click on the Secure ID box for the options.

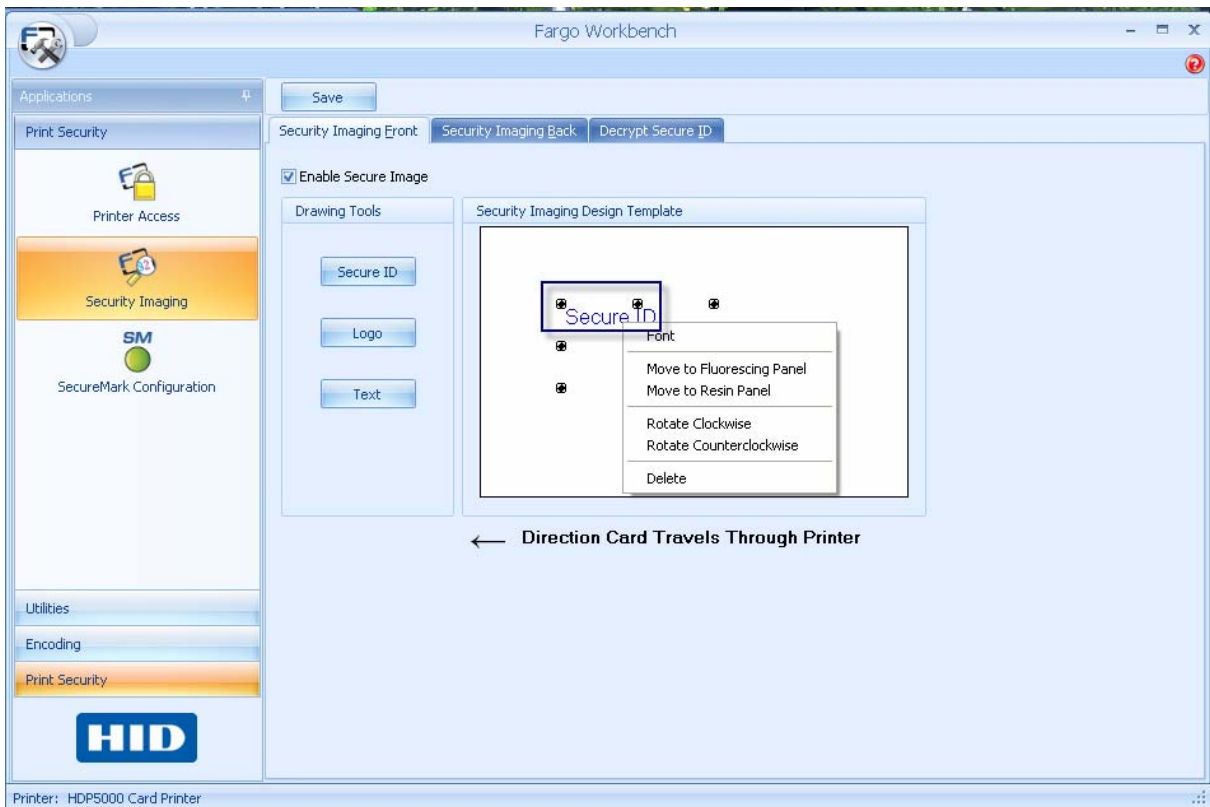

Configuring Fluorescent Data (F-Panel for YMCFK Ribbon) using the Workbench

Step	Procedure
5	a. Click on the Logo box on the left. b. Click and drag a box onto the Template. c. Move and size (as needed) by grabbing the corner of the box.

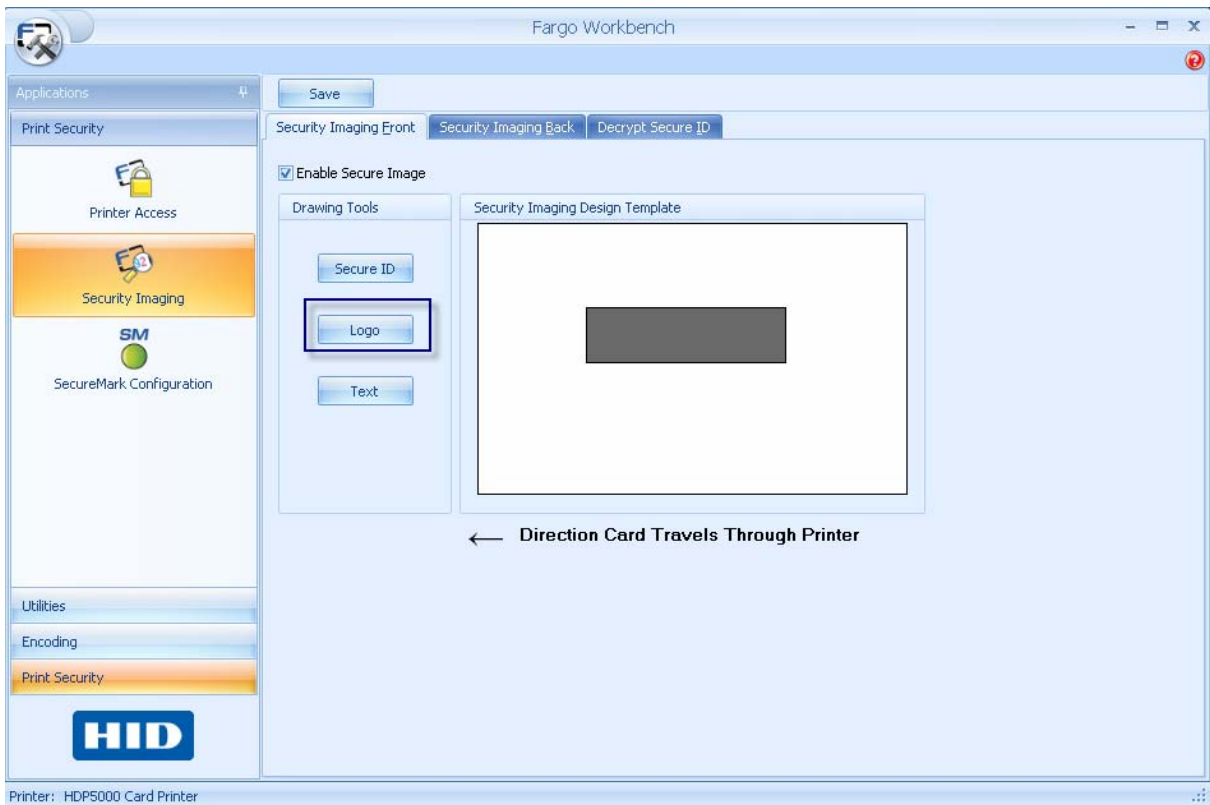

Configuring Fluorescent Data (F-Panel for YMCFK Ribbon) using the Workbench

Step	Procedure
6	On the Template right click on the Logo box for the options shown below.
7	Select Logo File. Find the source of the Logo to place on the card. (Note: Fit to Frame will size the image to fit the box. Once this is set up, this logo will print from the software program. This is set up in the background.)

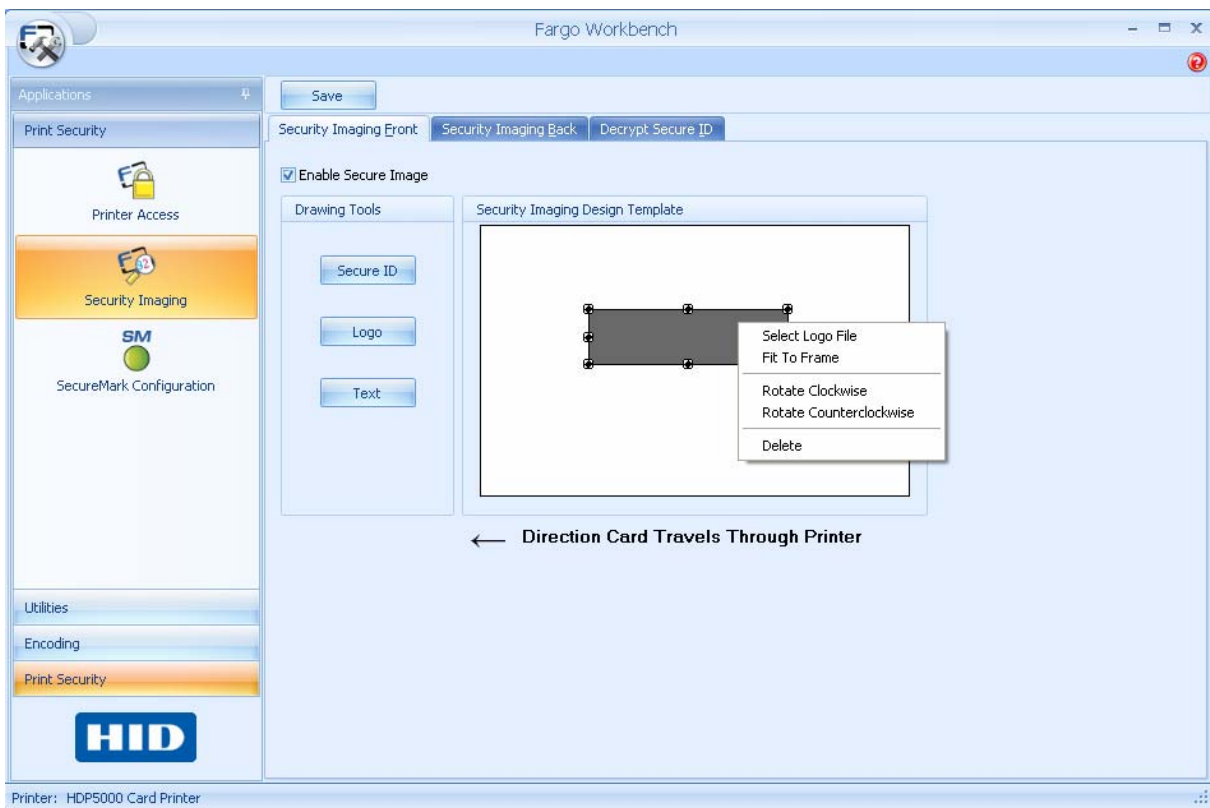

Configuring Fluorescent Data (F-Panel for YMCFK Ribbon) using the Workbench

Step	Procedure
8	<ol style="list-style-type: none"> Click on the Text box on the left. Click and drag a box onto the Template. Move and size as needed.

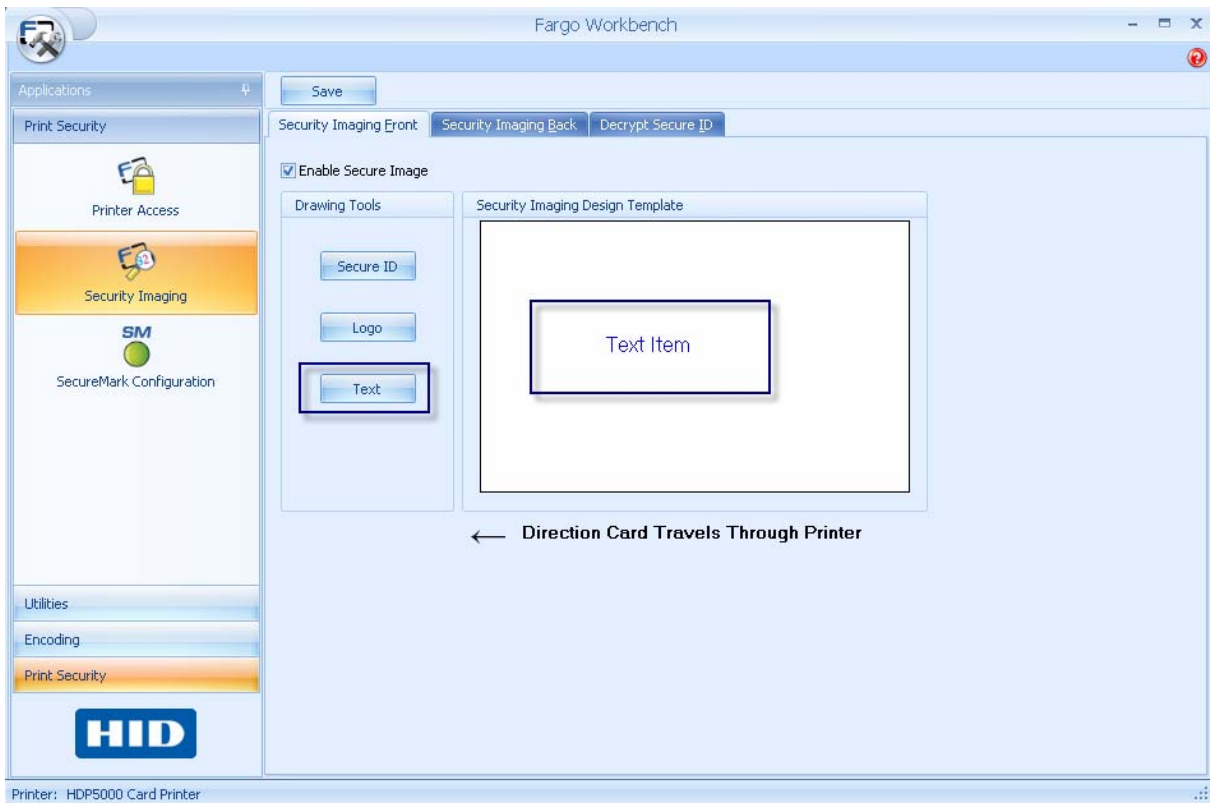

Configuring Fluorescent Data (F-Panel for YMCFK Ribbon) using the Workbench

Step	Procedure
9	On the Template, right click on the Text box for the options shown below.

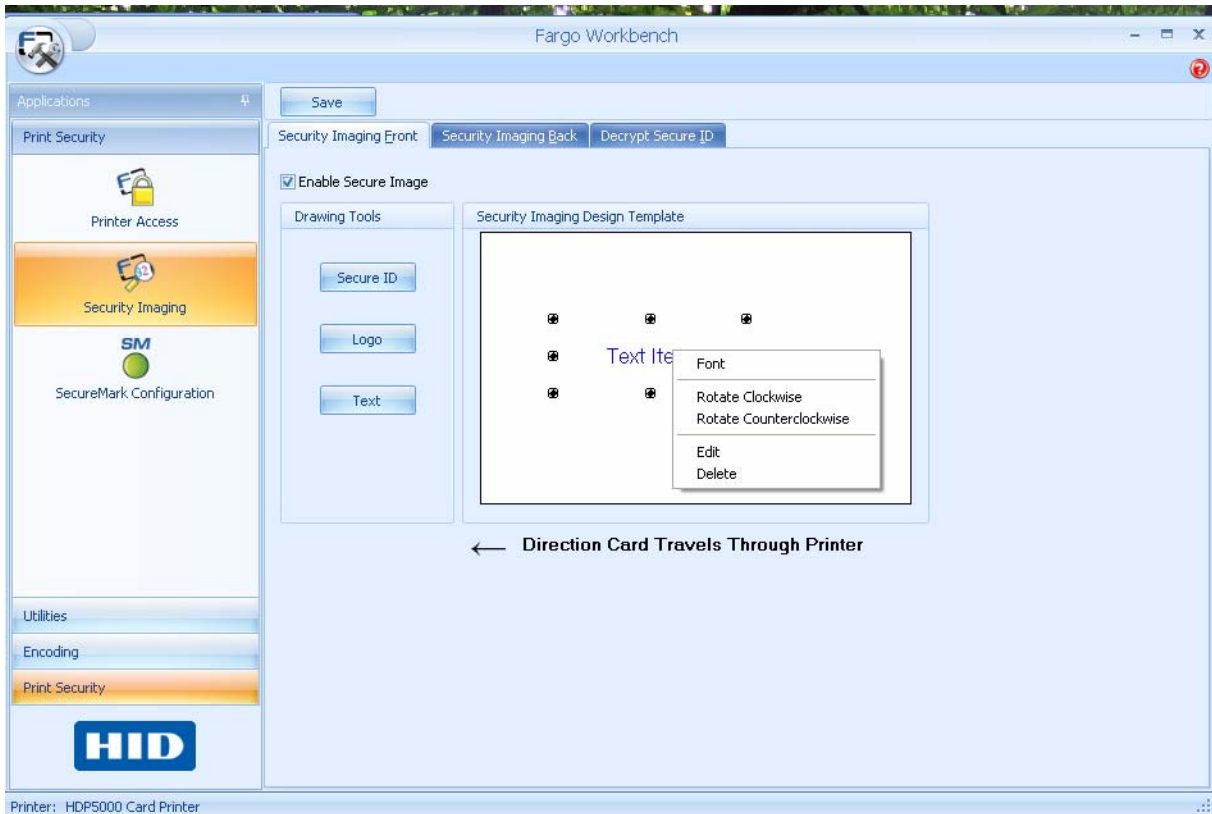

Configuring Fluorescent Data (F-Panel for YMCFK Ribbon) using the Workbench

Step	Procedure
10	Follow the same instruction as above for the back side of the card.
11	<ol style="list-style-type: none"> a. Save this template using the Save tab. b. Close the Workbench. (Note: Any Software program file printed with the YMCFK ribbon installed into the printer will print this design with the F panel of the ribbon. It will print the same file each time unless you recreate a new template.)

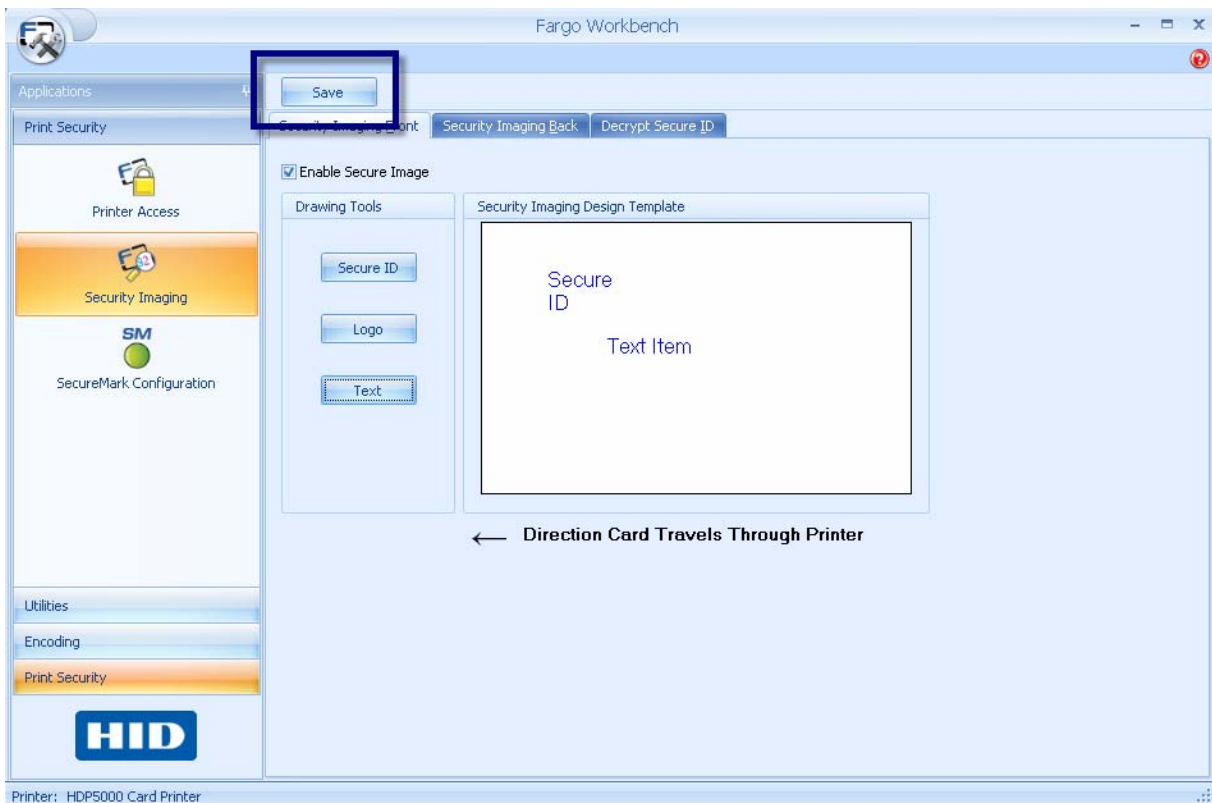

Configuring Fluorescent Data (F-Panel for YMCFK Ribbon) using the Workbench

Step	Procedure
12	Set the ribbon for YMCFK in the Printing Preferences. (Note: The Auto Detect button may also be used. The F panel ribbon must be installed for this process to work.)
13	Check Dual Pass if you would like to print the F panel on a separate panel of HDP film from the YMC image. (Note: It is recommended that the user use the default “Dual Pass” option if the fluorescent image is used in places where other dye is used or any time the “Invert F panel Image” option is selected)
14	Check Invert F-Panel Image to create a negative of the fluorescent image. (Note: This may improve the look of the person’s image if used for the Logo.)

Configuring Fluorescent Data (F-Panel for YMCFK Ribbon) using the Workbench

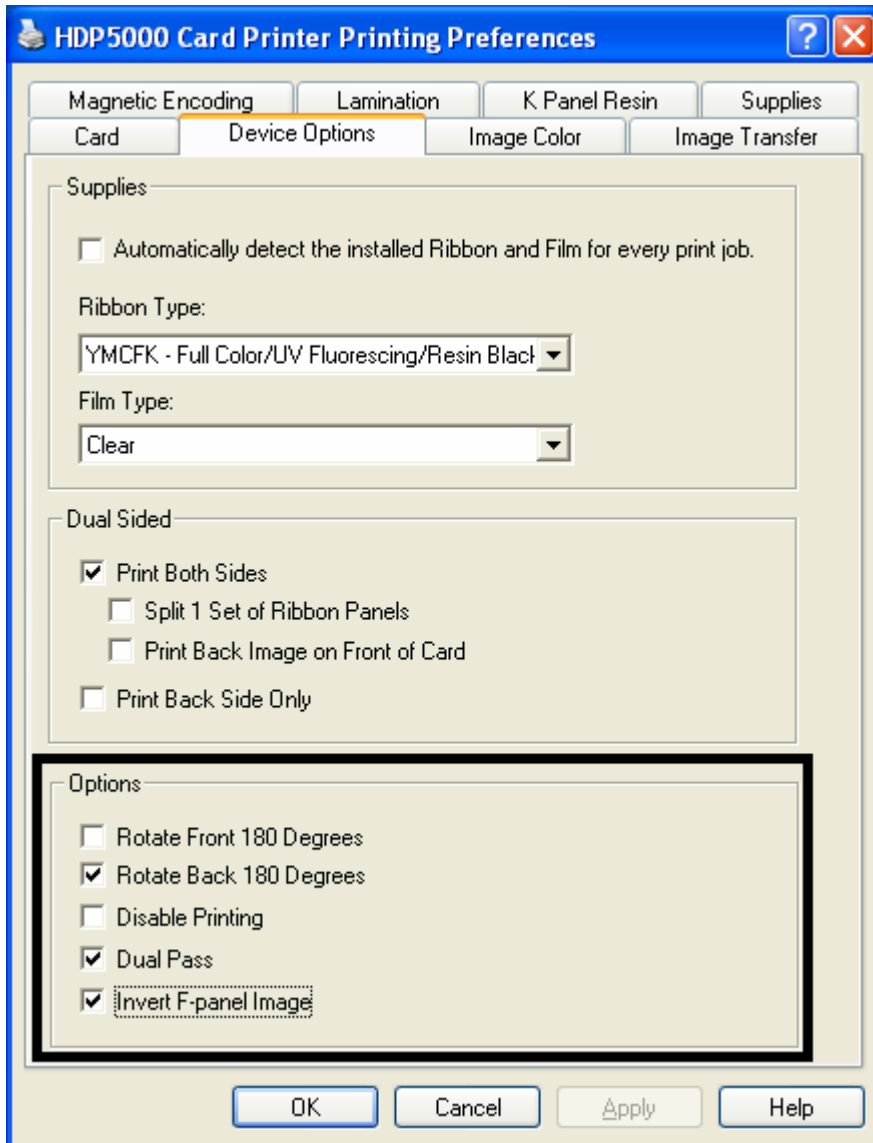

Configuring Fluorescent Data (F-Panel for YMCFK Ribbon) using the Application

This process creates a fluorescent image on your card using a simple text string command in your badge application.

Step	Procedure
1	Creating Fluorescent Text: Create a new text box in your badge application.
2	Type the TEXT that you want to appear as fluorescent and put a ~T before the start of the text with no space after the ~T . The text will start on the card where the ~T begins. (see Display A below)
3	Creating a Fluorescent Image: In a separate drawing program, create the image that you wish to fluoresce. (See Display C below)
4	Create the IMAGE in the actual size that you want it to appear on the card, and save it as a "Grayscale" or "1 - bit" bmp file on the root c:\ directory. Do not put spaces in the file name.
5	Create a new text box in your badge application, and type ~I followed by the address of your image (see Display A below). The top left of your image will start at the top left of your text box.
6	Set up the printer driver preferences. Refer to Step 8-10 below
7	Printer will print the fluorescent BMP IMAGE at the ~I position on the card. Printer will print the fluorescent TEXT at the ~T position on the card. (See Display B below)

Configuring Fluorescent Data (F-Panel for YMCFK Ribbon) using the Application

Display A
Card as seen in badge application



Display B
Card as Printed

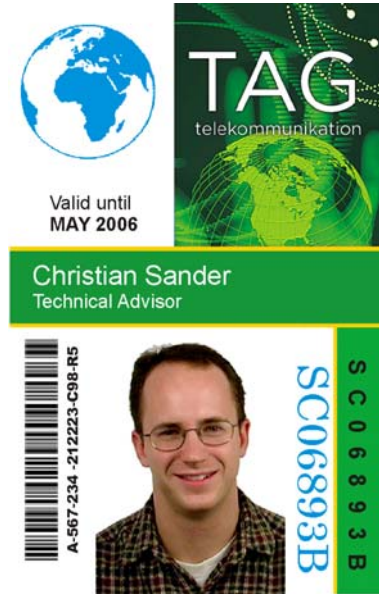

Configuring Fluorescent Data (F-Panel for YMC FK Ribbon) using the Application

Step	Procedure
8	Set the ribbon for YMC FK in the Printing Preferences. (Note: The Auto Detect button may also be used.)
9	Check Dual Pass if you would like to print the F panel on a separate panel of HDP film from the YMC image. (Note: It is recommended that the user use the default “Dual Pass” option if the fluorescent image is used in places where other dye is used or any time the “Invert F panel Image” option is selected)
10	Check Invert F-Panel Image to create a negative of the fluorescent image. (Note: This may improve the look of the person’s image if used for the Logo.)

Display C:
BMP Image located at c:\globe.bmp



Section 14: Inhibit Panel Usage

You can use the Inhibit Panel (I designation under YMCKI) to define areas on the surface of the card, in order to prevent the transfer of film to the card surface. Examples of where the I Panel has potential use are to ensure that signature panels, security holograms or pre-printed graphics are not covered or obscured by print images or transfer film.

- **When Active:** This feature is active when using YMCKI Ribbons.
- **Application Usage:** An application which supports the use of text based objects is used to access and work with the Inhibit Panel.

Using Inhibit Panel (via the Fargo Workbench Printer Utility)

You can use the Fargo Workbench Printer Utility to generate an Inhibit Panel Layout. (**Note:** This utility allows the operator to add a rectangular area(s) that define which areas are to be inhibited.)

- **Inhibit Panel Placement:** Each print job (generated from that individual client workstation) will generate the instructions within the print job that place the corresponding area(s) on the I-panel.
- **Operating Systems:** This method works on all applications generating print jobs to the HDP5000 under all operating systems. (**Note:** This is regardless of whether the printer (being used) is a shared instance from another workstation or an instance local to that particular workstation.)

Using Inhibit Panel (via the Fargo Workbench Printer Utility)

Follow these instructions:

- To create an inhibit area using the Fargo Workbench Printer Utility, see **Using the Inhibit Panel Layout Applet** in the Help file associated with the specific application.
- To open the Fargo Workbench Printer Utility, select (on your desktop)

Start > Programs > Fargo > Fargo Workbench Printer Utility > Fargo Workbench

- Please verify that you have the latest version of the Workbench installed. The latest version is located on www.hidglobal.com

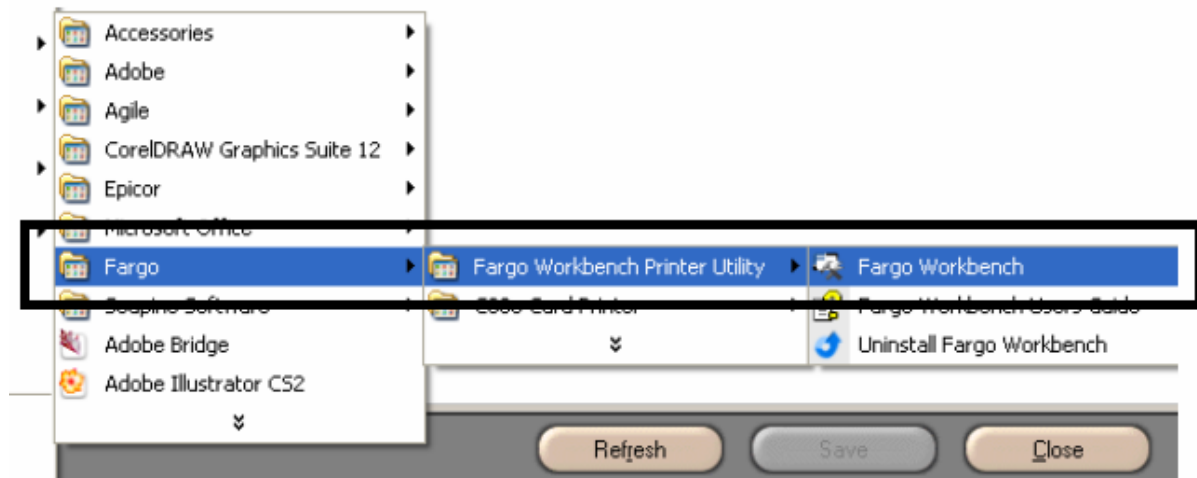

Using Inhibit Panel (via the Fargo Workbench Printer Utility)

Step	Procedure
1	Create the Inhibit Panel Layout within the Workbench Printer Utility.
2	Save the file. Failure to save will not allow the Inhibit Panel to work
3	You are now ready to print from your application. Any image file will print with the inhibit panel until that image file is deleted.

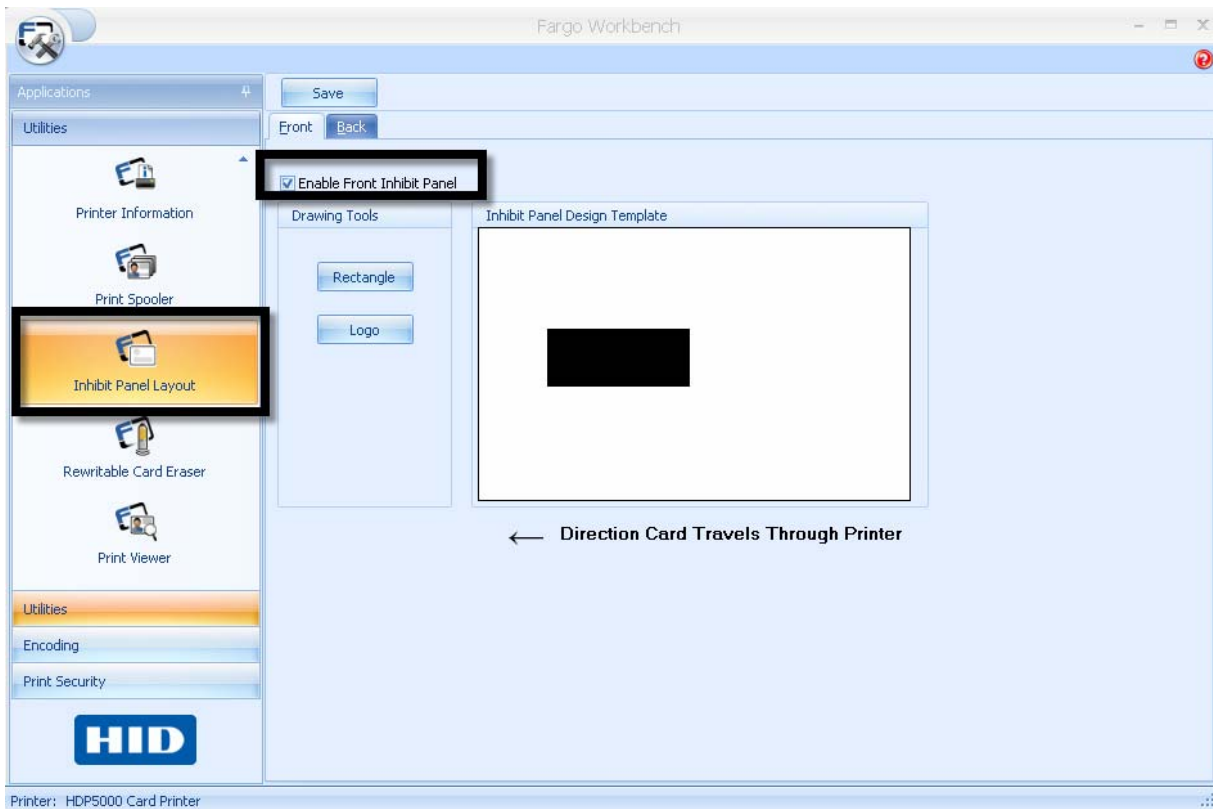

Using Inhibit Panel with an Application

Some applications can utilize the inhibit panel by using text objects containing a “~i” within the print job itself. The “~i” is followed by the file path and file name of a bitmap file, which is merged when the print job is rendered.

- Rendering is the process which changes the application output to instructions that the printer understands.
- This string will be removed from the print and the bitmap will be used to define the area where the transfer is to be inhibited.

Generating Text Objects

- **Incompatible Applications (which do not print text as objects):** Some Windows applications create print jobs, but do not generate text objects within the print job output.
 - These types of application are not compatible with the inhibit panel and will not generate the correct print output. If an application saves its files as a single bitmap the text will not be sent to the printer to be handled correctly.
 - In this case the “~i” string may appear printed on the card instead of being substituted with the inhibit bitmap.
 - Examples of applications (which are incompatible with inhibit printing) are Notepad and Microsoft Paint. Microsoft Paint can be used for the creation of the INHIBIT BMP.
- **Compatible Applications (which utilize text objects compatible with the Inhibit Panel):** Windows applications which generate text objects to Windows GDI are compatible with inhibit panel operation. (**Note:** Compatible applications will allow you to edit text strings after the file has been saved. Examples of compatible applications are Corel Draw, Microsoft Word, and Microsoft WordPad.)

Rendering Print Jobs

Rendering of the print job occurs on the given local workstation if the Printer Driver is installed for use on that particular workstation.

- **Shared Instance:** However, if the Printer Driver is a shared instance (e.g., shared from another workstation), the print job is rendered (converted to something that the printer understands) on the workstation where the Printer Driver is shared from while under Microsoft Windows 2000, XP and 2003.
- **Print Job Rendering:** Under Microsoft Windows Vista, the rendering of the print job may be performed on either the workstation sharing the printer or the workstation creating the print job, depending upon the setting chosen in the printer instance.
- **Rendering Engine:** Since the Printer Driver looks for the file with the “~i” command, the file location specified within the command is relative to the sharing workstation on Windows 2000, XP and 2003.
 - Under Windows Vista the default configuration is to render the job on the workstation that is generating the print job.
 - The bitmap image file must exist in the location specified on the sharing workstation or on the printing workstation, depending upon your settings for that printer on the workstation generating the print job.
- **Example:** Place a “~iC:\Test\inhibit.bmp” text object within a Word Pad print job against a non-shared (e.g., local) HDP5000 printer under Windows XP to cause the Printer Driver to look for a file with that name and location on the local workstation. (**Note:** This is because the Printer Driver processing occurs on the local workstation.)
- **Inhibit Area Location:** The location of the inhibit area within the print job is the upper left hand corner, where the text object is placed upon the drawing within the application. (**Note:** The inhibit file bitmap must contain one bit per pixel (e.g., monochrome).)
- **Print Size:** If the inhibit bitmap is larger than the page print size, it is trimmed to fit it. The normal print size for a HDP5000 CR-80 card is 2.204 inches by 3.452 inches.
 - With that print size, the maximum size of the inhibit bitmap area would be 661 pixels by 1035 pixels.
 - If the inhibit bitmap is smaller than the page print size, it will still be used by the driver and be referenced to the upper left hand corner of the ~i text object.
- **Bitmap Black Areas:** The black areas of the bitmap are the areas that will correspond to where the inhibit material will prevent the transfer of dyes on to the card.

Rendering Print Jobs

The inhibit bmp file can be generated with any bit map editor. The following procedure explains how this is done with Microsoft Paint.

Step	Procedure
1	Create a bitmap file using Microsoft Paint. Note: The size for landscape orientation is 1035 pixels in width and 661 pixels in length. The size for portrait orientation is 661 pixels in width and 1035 pixels in length. Set this under Paint –Image –Attributes. Select “black and white” under COLORS.

Landscape Orientation (see below)



Portrait Orientation (see below)

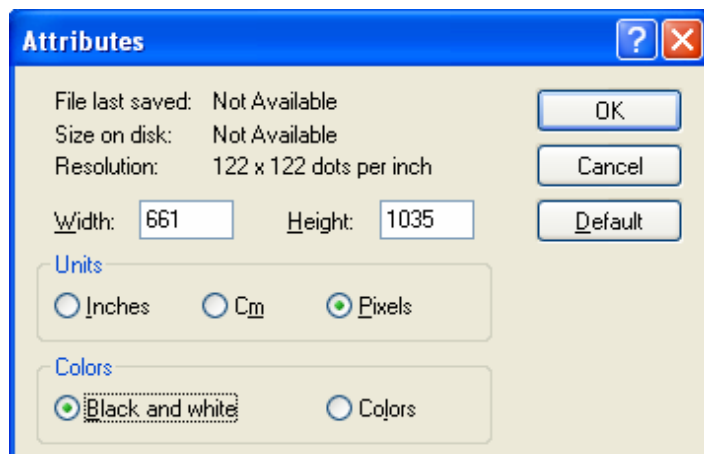

Rendering Print Jobs

Step	Procedure
2	Place objects on the image, which correspond to the exact areas that are being inhibited.

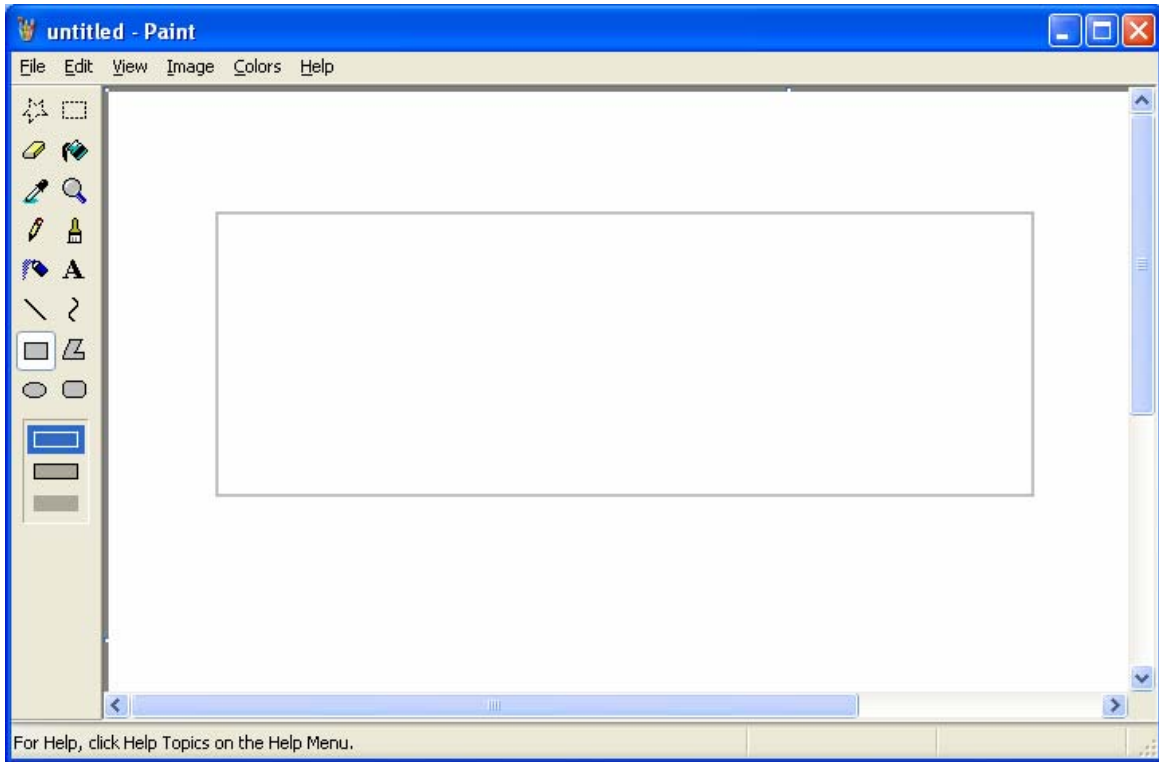

Rendering Print Jobs

Step	Procedure
3	Fill the inhibit areas with black color.

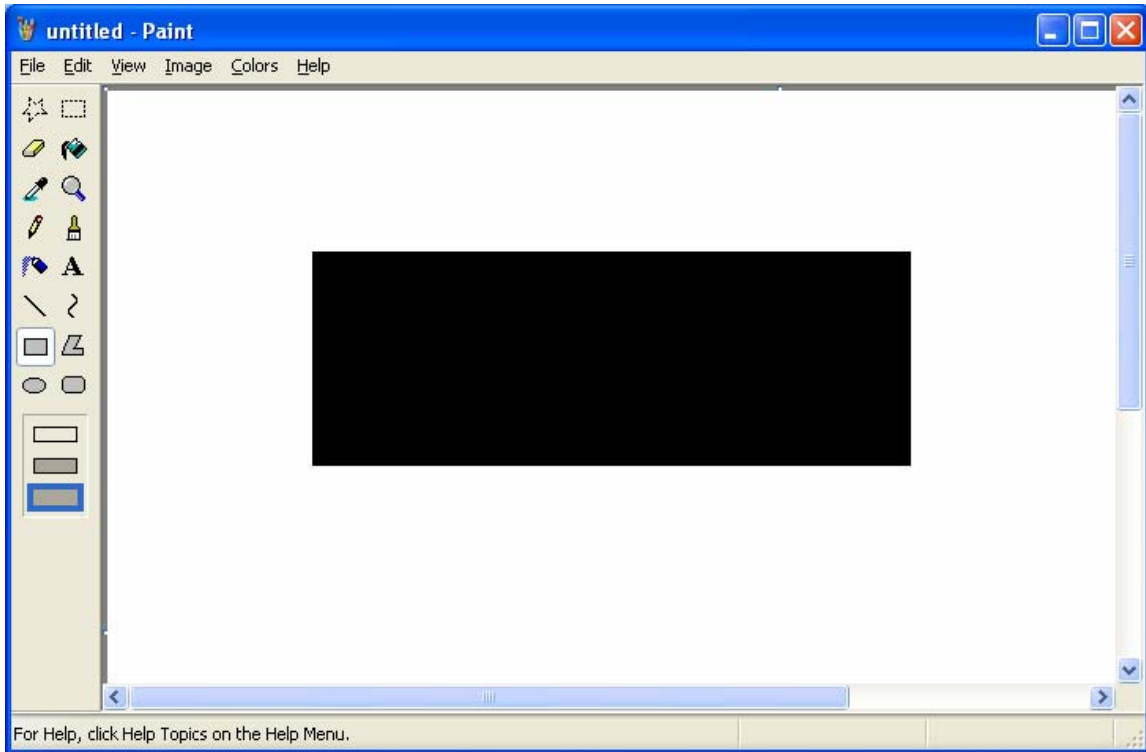

Rendering Print Jobs

Step	Procedure
4	Save the file as a BMP from within Microsoft Paint.

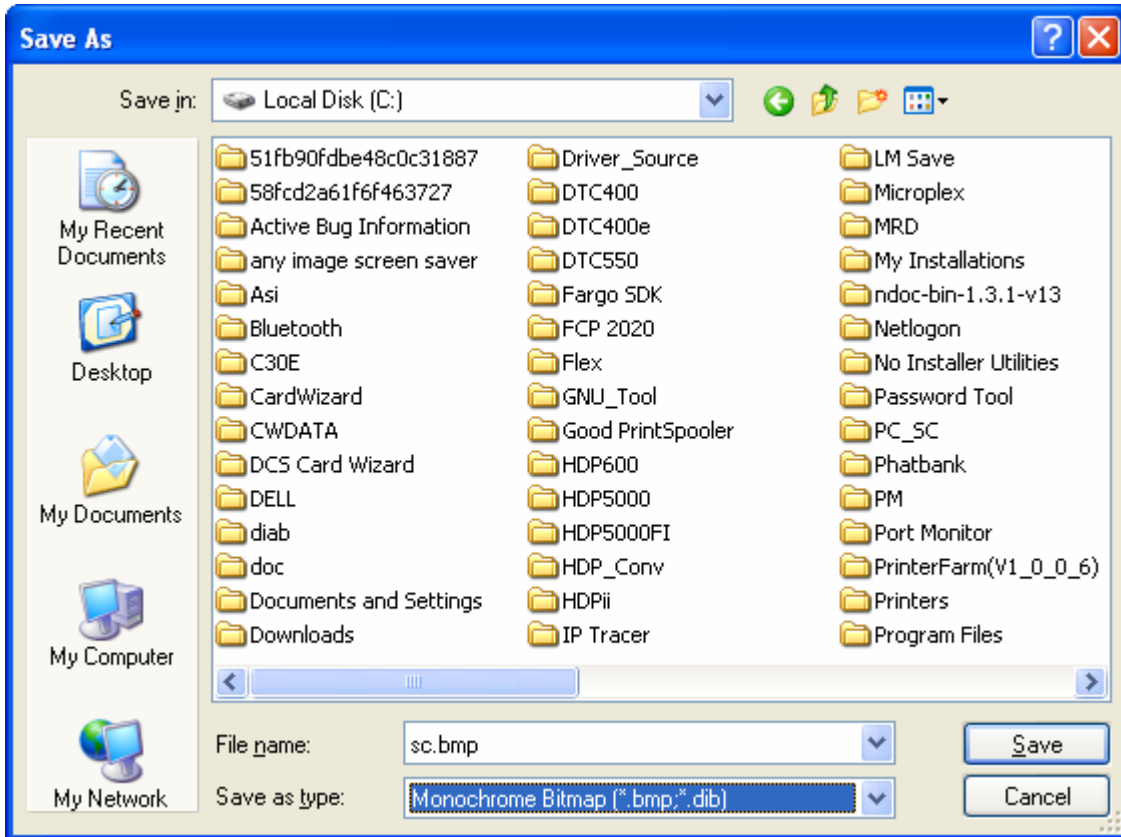

Rendering Print Jobs

Step	Procedure
5	Add the '~ ' command to the application file. (Note: In this case, Microsoft WordPad was used. With WordPad the '~' must be left justified.)

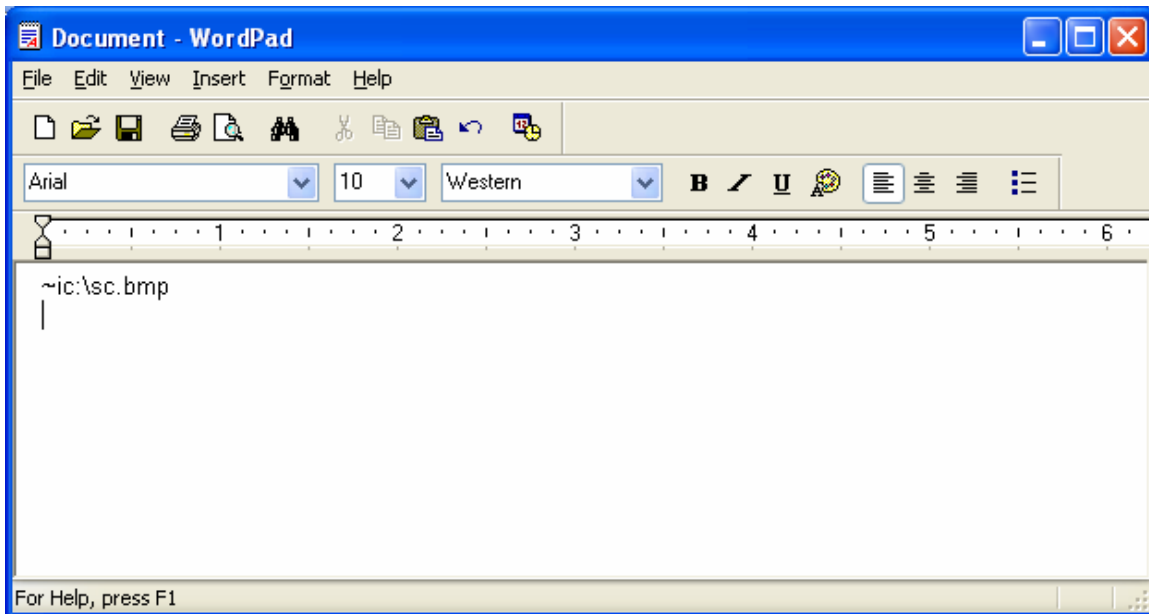

Rendering Print Jobs

Step	Procedure
6	Create the rest of the card using the application.



Rendering Print Jobs

Step	Procedure
7	Print the card from within the application. (Note: In this case, use File -> Print.) If the ~i text object is printed on the card see Troubleshooting the Inhibit Panel
8	This completes the procedure..

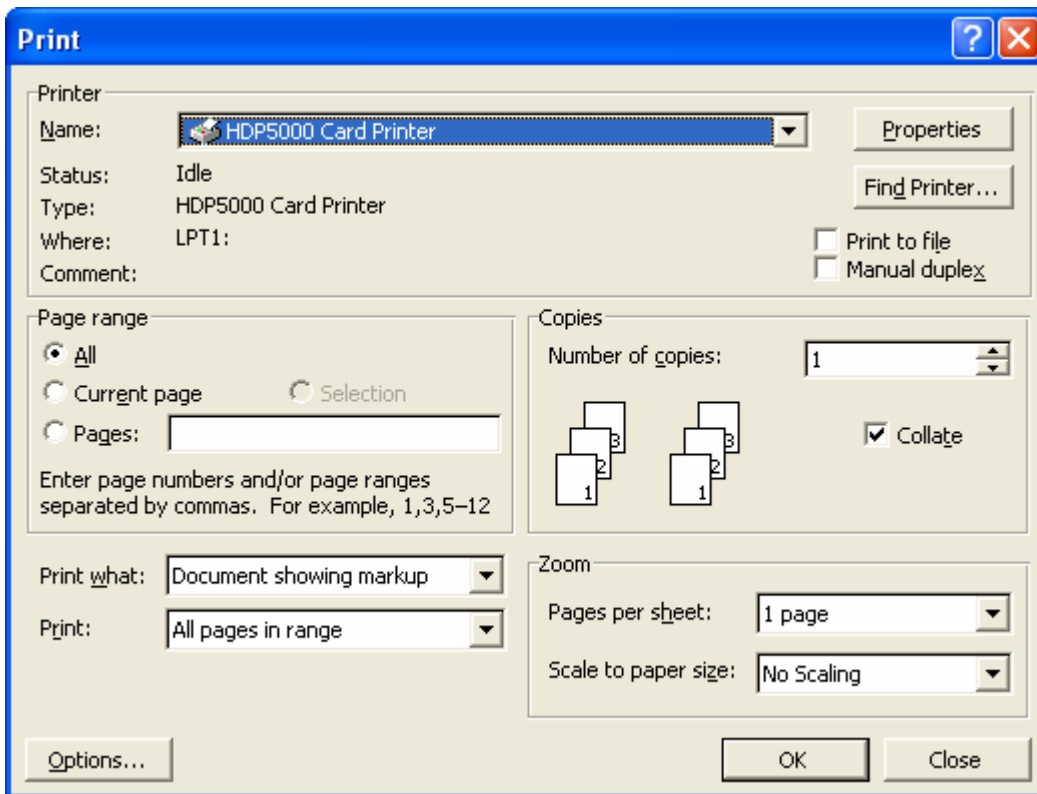

Using the Test Print

The printer has a test print file, which can be sent to the printer to verify the Inhibit Panel functionality. This test image uses a pre-formatted inhibit area and will not test a user-defined inhibit bitmap. To use this test of the inhibit panel perform these steps.

Step	Procedure
1	Bring up the Printer Preferences dialog via Start -> Settings -> Printers and Faxes . Right click on the HDP5000 printer instance; then left click on Printer Preferences to select the Card tab.
2	Click on the Test Print button.

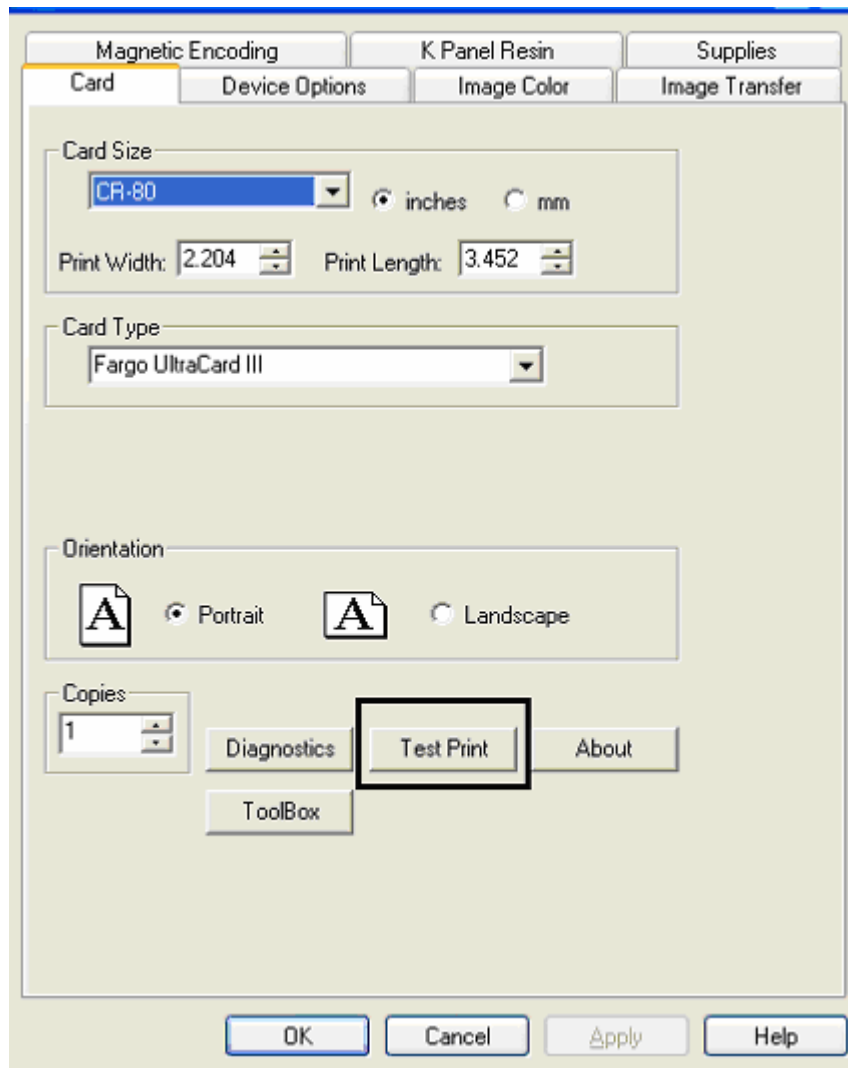

Using the Test Print

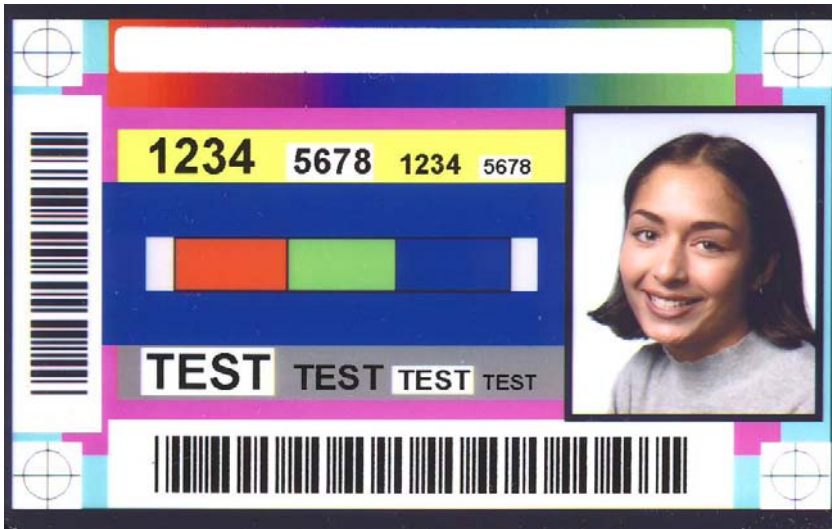

Troubleshooting the Inhibit Panel

If you are having trouble getting the Inhibit Panel to produce the expected results, verify the following information.

- You have used a lower case “~i”, not an upper case “~I”. Some applications have an auto-correct feature that will change the case on the small ‘i’.
- The bitmap file (being used) is at the location on the workstation (see notes above regarding shared printer instances) as specified by the text object.
- The bitmap file is monochrome (e.g., black and white).
- The size of the bitmap image is large enough to cover the space you are seeking to inhibit. (**Note:** The printer resolution is 300 dpi on both the horizontal and vertical axis, which will aid you in placement of the image. Oversize images will be truncated at the size of the card.)
- The bitmap image should be created in the same orientation as your application image (e.g., landscape or portrait).
- Some Windows applications have a mode where prints are converted to a bitmap before printing which will prevent proper inhibit panel operation.
- In some applications, such as Microsoft WordPad, the ‘~’ must be left justified or it may print on the card and the inhibit functionality will not work.

Section 15: Packing the Card Printer

The purpose of this section is to provide the User with a specific packing procedure for the HDP5000.

(Note: Do not install the Lamination Module to the Printer before shipping. The Lamination Module must be packaged in its own box and shipped separately, then installed at the site. Attaching both modules together before shipping may cause damage.)

Follow this instruction to pack the Card Printer for transport.

Step	Procedure
1	Clean the inside of the Printer with deionized air. Wipe it down with a lint-free cloth.
2	Clean the Printhead with a Printhead swab.
3	Pack the Printer in the original carton and packing materials.
4	Be sure to enclose any necessary paperwork, test cards, etc.

Section 16: Firmware Updates

The purpose of this section is to provide the User with information on the internal software or Firmware, which controls all aspects of the Printer's operation. New Firmware versions may be released containing enhancements, such as improved reliability, added features or better print quality. New Firmware updates can be downloaded from the Internet.

- Refer to the **Fargo Workbench Printer Utility User Guide** to download and install Firmware updates. See the Fargo website to access this document.
- **Important:** This is a new Printer. Once new Firmware is released and made available (via Step 2 below), Steps 3 through 14 in this procedure will be enlarged with “real world” populated windows and dialogs. Until that time, please review this procedure only for future use.

Performing the Firmware Updates

Step	Procedure
1	Type in: www.hidglobal.com to bring up the web site, as shown below.

Display A – Card tab (**Diagnostics** button)

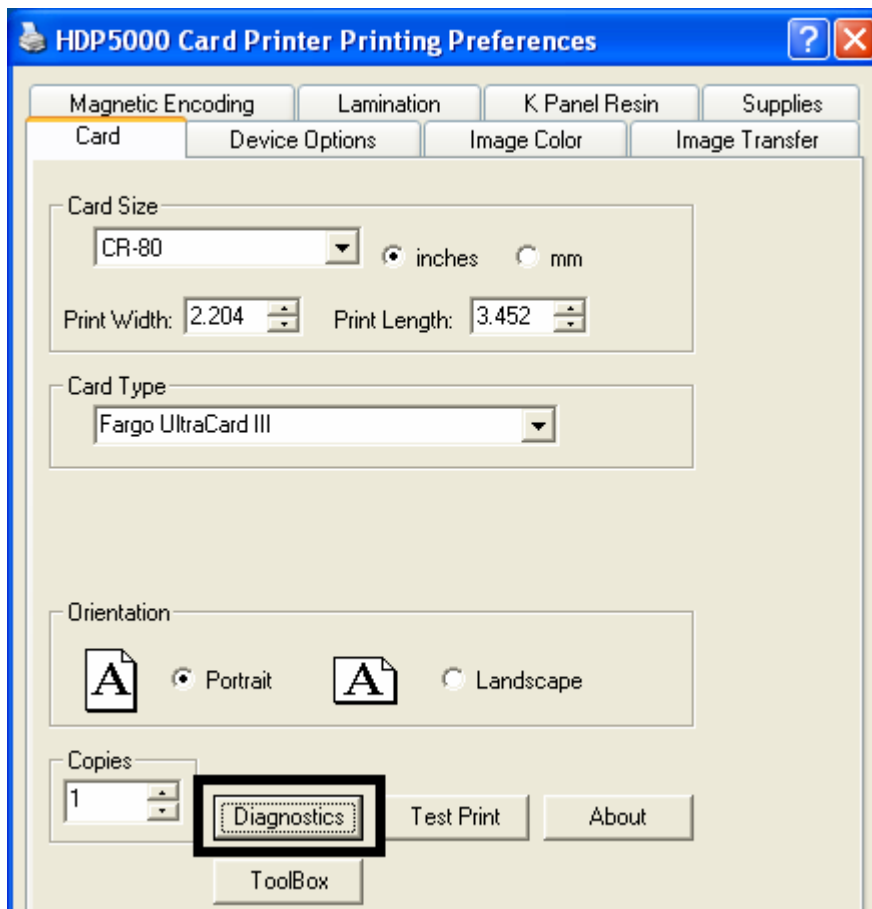

Performing the Firmware Updates

Display B – Fargo Workbench Printer Utility (Printer Information tab)

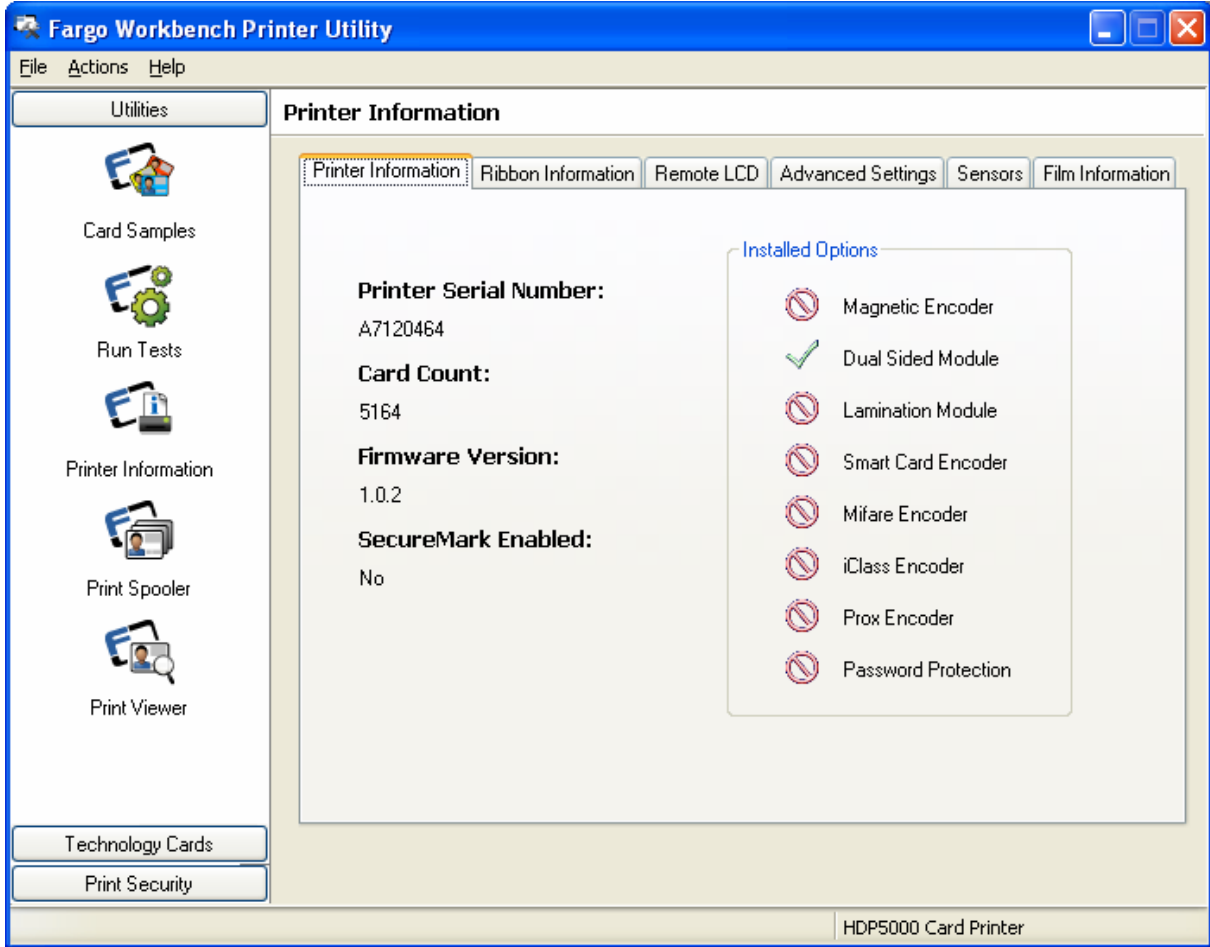

Performing the Firmware Updates

Step	Procedure
2	<p>This will launch the Support page.</p> <ul style="list-style-type: none"> • Click on the Firmware selection box. • Using the drop down menu, select the Printer. • Click on the Go button, as shown below.



Performing the Firmware Updates

Step	Procedure
4	Click on the Printer name under Printer Firmware to begin the download.
5	Click on the Save button to save the file.
6	Click on the Save button to save the file to the computer's Desktop.
7	Click on the Close button to close this dialog when the download is completed.
8	From the computer's desktop, double click on the Firmware .exe file to un-zip it.
9	Click on the Browse button on the WinZip Self-Extractor window.
10	Select the Desktop, and then click on the OK button in the Browse for Folder dialog.
11	Click on the Unzip button in the WinZip Self-Extractor window to unzip designated files.
12	Select Upgrade Firmware in the Actions dropdown menu, as shown below. This brings up the Upgrade Firmware window, as shown below. See the Fargo Workbench Printer Utility User Guide at this time.

Performing the Firmware Updates

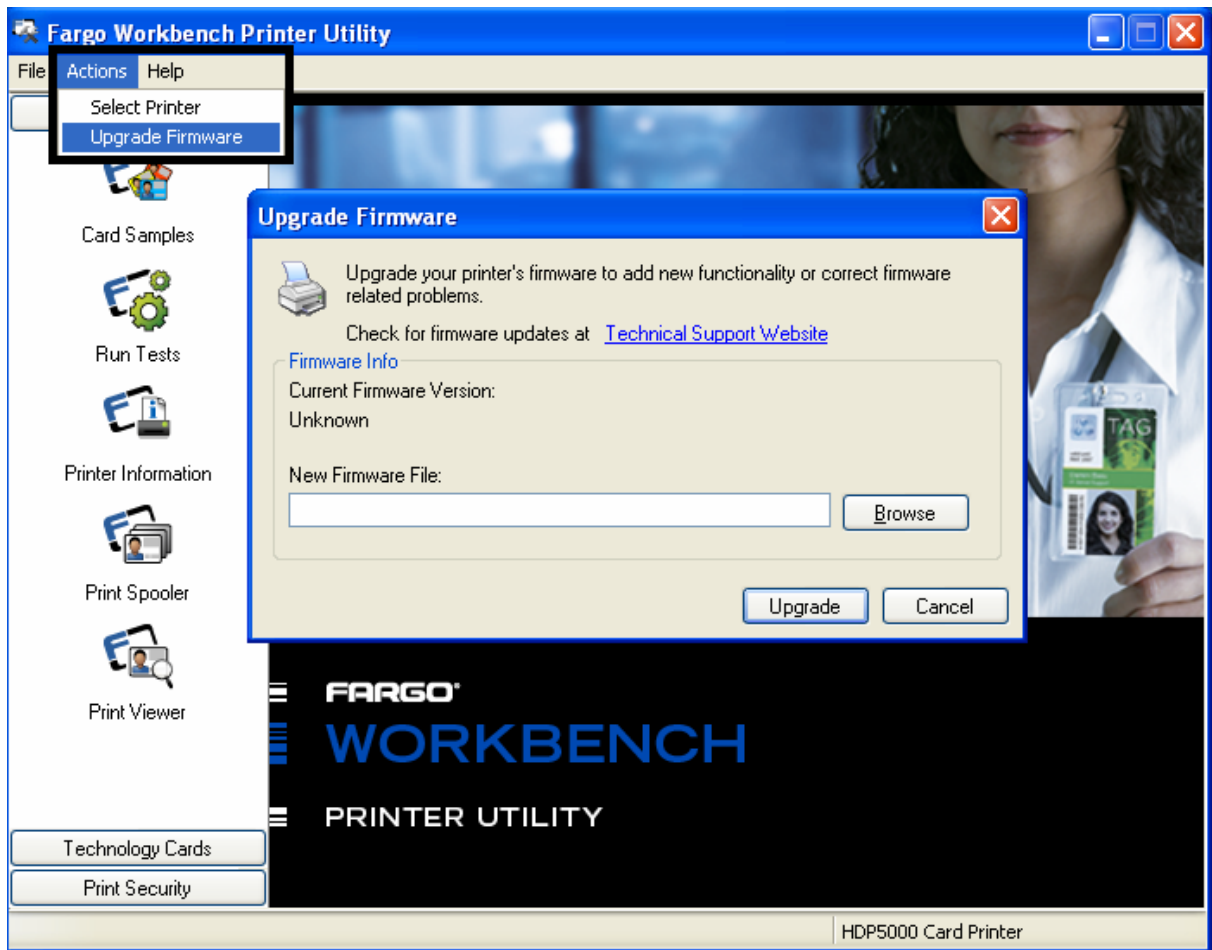

Performing the Firmware Updates

Step	Procedure
13	<ul style="list-style-type: none">• Select the Desktop from the Browse menu.• Click on the .frm file.• Click on the Open button.• Click on Upgrade to send the Firmware to the Printer.
14	This completes the Firmware Update process.

Section 17: HID Global Technical Support

The purpose of this section to provide the User with an efficient, step-by-step procedure to be used when contacting Fargo Technical Support as needed for the HDP5000.

Contacting Technical Support

Step	Procedure
1	<p>Read the suggested Sections of the Technical Service and Maintenance Manual in order to troubleshoot the Card Printer.</p> <p>As needed, contact the Fargo Technical Support Group by phone at (866) 607-7339 #6 or by fax at (952) 946-8492 for additional, technical assistance.</p> <p>OR</p> <p>Contact Technical Support via the Web: www.hidglobal.com</p>
2	<p>Position a phone near the Printer and Computer so the technicians can troubleshoot the Printer(s) with efficiency.</p>
3	<p>Please have a self-test and a sample card ready when calling HIDGlobal Technical Support.</p>

Reading the Serial Numbers on the Printer

The purpose of this section is to provide updated instructions for reading serial numbers on a Fargo Printer.

Finding out when a Fargo Card Printer was manufactured

You can determine when your card Printer was manufactured by reading directly from the serial number (affixed to your card Printer).

- **Year Built:** The first two digits in the serial number indicate the year that the Printer was manufactured.
- **Week Built:** The second two digits indicate the week.
- **Numeric Order:** The last four digits indicate the sequence number for the numeric order in which the Printer's were built.

Reviewing Example: Serial Number A9090001

- **A9090001:** The first two digits in the serial number indicate the year the Printer was built (e.g., the letter and digit A9 indicate the year 2009).
- **A9090001:** The third and fourth digits in the serial number indicate the week the Printer was built (e.g., the digits 09 indicate week 9 of that year).
- **A9090001:** The last four digits indicate the sequence number for the numeric order in which the Printer's were built.

Reviewing Example: Serial Number B0090001

- **B0090001:** The first two digits in the serial number indicate the year the Printer was built (e.g., the letter and digit A9 indicate the year 2010).
- **B0090001:** The third and fourth digits in the serial number indicate the week the Printer was built (e.g., the digits 09 indicate week 9 of that year).
- **B0090001:** The last four digits indicate the sequence number for the numeric order in which the Printer's were built.

Section 18: Glossary of Terms

Term	Definition
24-bit color	A color depth for an image that uses 8 bits for each color (red, blue, green) combining the possible 256 shades to provide a color depth of 16.7 million colors.
AC - Alternating Current	An electrical current that reverses its direction at regular intervals (typically 50 - 60 times a second).
Adhesion	The firm attachment of a material to the card surface, confirmed by using the Tape Test -pulling an applied piece of adhesive tape (Scotch 600 or equivalent) off the card at 1 sec/in to see if any material is pulled off by the tape.
Algebraic	A type of color matching that takes the colors value of pixels and applies them to an algebraic equation to adjust the levels of hue, saturation and brightness.
ANSI (American National Standards Institute)	The United States Representative to ISO, providing standardization for U.S. Manufactures prior or in addition, to acceptance by ISO.
ASCII (American Standard Code for Information Interchange)	A standard for processing information in computer processors. An 8-bit character set of 255 decimal numbers, each assigned to numbers, letters, punctuation and special characters.
AT	Refers to an IBM standard in early computing with regard to the chipset and function of the Parallel Port, set up in the BIOS.
B (Black)	Black Dye-Sublimation panels are distinguished from the black panel using resin by the use of B for Dye-Sublimation black. K denotes resin black.

Section 18: Glossary of Terms

Term	Definition
Barcodes	A series of alternating black and white stripes, of varying widths (each character denoted by a set number and width of black stripes) that allows characters to be optically read by a computer.
batch print	A file sent down from the computer that contains commands to print a number of cards, sequentially.
Battery Back-up	A power supply that can keep AC electronic equipment running for a short time when power is interrupted, allowing enough time for the User to save data and close the machine properly.
Bi-directional	A communication standard that allows two-way data transfer between PC and Printer.
BIOS (Basic Input/Output System)	The part of the operating system in a computer that handles communication between the PC Board and its peripherals. Typically residing in chip-based, non-volatile memory.
Bit	An abbreviation for binary digital. Each bit is an element of information that can have two states: off and on.
Bit map	A graphic produced by an array of pixel elements with the color hue, brightness and saturation information stored in bits. The more bits, the more values and thus the greater variety. 1 bit color is black and white, 8-bit color produces 256 shades of gray and 24-bit color can produce 16.7 million colors.
Board	A term used for the circuit Board, a hard mylar plate made of many layers, that holds the electronic circuit elements and wire traces.

Section 18: Glossary of Terms

Term	Definition
Boot-up	A series of operations that the Printer runs through when power is first applied including a series of initializing, status testing and a diagnostics program to ensure a ready state.
Buffer	A block of memory, in the Printer or PC, that holds print files until the processor is ready to print them.
Cable	A set of conductors wrapped together and often concealed within insulation, used for signal transfer from one device to another, with connectors on either end that allows the cable to be removed.
Cache	A type of memory Buffer to store data temporarily, used to hold information that is most often exchanged between controller and peripheral, to expedite data transfer.
Calibrating	A procedure to adjust an electro-mechanical device so that it operates within established parameters.
Cleaning Roller	High tack Rollers positioned just after the input hopper to lift debris off the card as it rolls over it. A clean card surface improves print quality.
CD (Compact Disc)	A 4.75 inch (12 cm) optical disk that stores data, written too and read from using a laser.
DMA (Direct Memory Access)	Channels designated within the Windows operating environment that are used for dedicated high-speed communication between the PC and the Printer port.
Centronics	A parallel communications interface that has become the standard for connections to Printers, designed by the Centronics Corp.

Section 18: Glossary of Terms

Term	Definition
Coercivity	The property of a Magnetic Stripe that indicates the amount of force needed before magnetic saturation, measured in Oersted (Oe).
Color matching	The process of adjusting color hue, saturation and brightness, to duplicate a desired color. An algorithm within the Driver, which adjusts the color balance and provides output with the desired color, automates this process.
Compressed air	Air stored in a tank or produced by an aerosol can, delivered by through nozzle at a high speed. Used in the Printer to blow out debris.
Contrast	The degree of difference in luminance of two areas.
Control panel	The panel on the Printer from which the User can control Printer functions. The Printer is usually composed of the control buttons and an LED or LCD display.
CR-79	A card dimension standard of 2.0625 L X 3.3125 W (+/-0.002 W, +/-0.005 L) or 52.400 X 84.150 mm.
CR-80	A card dimension standard of 2.125 X 3.370 (+/-0.002 W, +/-0.005 L) or 53.975 X 85.598 mm.
CR-90	A card dimension standard of 2.375 X 3.625 (+/-0.002 W, +/-0.005 L) or 60.325 X 92.075 mm.
CR-100	A card dimension standard of 2.625 X 3.875 (+/-0.002 W, +/-0.005 L) or 66.675 X 98.425 mm.

Section 18: Glossary of Terms

Term	Definition
Cursor	The marker in the LCD display Window that indicates the active selection.
Darkness	A reference to color saturation.
DB-9	A 9 pin, D-shaped connector, typically used in serial port interfaces.
DC Motor	A Motor that works on DC with continuous motion.
DC (Direct Current)	Electronic flow that is unidirectional, flowing from the positive (+) to negative (-) of a power source.
Default	A setting or parameter that comes preset from the factory in Driver or Firmware. Performance parameters can be customized in the Driver, but can be reset to the factory values usually through the push of the default button. The default values for the Firmware are usually denoted on a label attached to the Printer.
Defrag	Abbreviation for defragmenting. The process of positioning the data in contiguous sections on a hard drive so that it uses space more efficiently.
DIP switches (Dual In-line Package Switches)	A small array of mechanical switches installed on the Board that can be configured to change Printer operations including providing a variety of self-tests.
Direct-to-Card (DTC) Printing	The Direct-to-Card printing process prints digital images directly onto any plastic card with a smooth, clean, glossy PVC surface.

Section 18: Glossary of Terms

Term	Definition
Dither	A system of distributing dots to control the hue, brightness and/or saturation. In monochrome printing, this controls the brightness. In color printing, Dithering can supply a larger color gamut than non-Dithering. In the Driver, Dither modes can be selected to provide better image quality depending on the type of image to be printed.
Dongle	A peripheral that attaches to a port to act as a key for an installed application. The PC is able to run that application only when the dongle is installed. Typically, it works as a pass-through device and is connected in serial to the parallel cable.
Dot	The smallest unit of an image that the Printer is able to produce. The smaller the dot, see dot pitch, the sharper the image.
Dot pitch	A measurement of image sharpness denoting the width of the dots that makes up a pixel. The smaller the pitch, the sharper the image.
Download	The transfer of a data file from one device to the other over a network or cable, typically from the Internet to a PC.
DPI (Dot Per Inch)	A measurement of the Printer resolution indicating how many dots a Printer can produce in a linear inch.
DRAM (Dynamic Random Access Memory)	A microchip based volatile memory storage device. The Printer uses this to Buffer a print job, transferred from the PC, until the Printer is able to process the packet.
Driver	Software utility installed in Windows, that interfaces an application to rasterize image data and include command codes so the Printer can process the file.

Section 18: Glossary of Terms

Term	Definition
Dual Pass option	<p>Dual Pass option: This refers to the fact that the fluorescing dye can be applied to a separate panel of HDP Film. (Note: First, the YMC ink is applied to a panel of HDP film; then, the F and possibly K are applied to a separate panel. If this is not done, the fluorescent ink tends to mix with the YMC colors and lose its fluorescent qualities; it also tends to become visible.)</p> <p>It is recommended that the user use the default “Dual Pass” option if the fluorescent image is used in places where other dye is used or if the “Invert F panel” option is selected.</p>
Duplex Printing	Printing on the front and the back of the card.
Dwell Time	The speed at which the card moves across the Transfer and Lamination Roller, measured in seconds/inch (sec/in). This can be adjusted in the Driver to ensure adhesion and card flatness.
Dye Migration	The diffusion of dye out of the card surface and into another receptive surface, such as a vinyl pouch card holder, resulting in a faded image.
Dye-Sublimation	Also called dye diffusion/thermal transfer, it is the process of heating a dye suspended in a cellulous substrate until the dye can flow, diffusing into the dye receptive surface of the card or InTM film. This produces the image in the surface of the card.
E-card	An abbreviation for electronic card. A generic term used to reference any card with built-in electronic devices such as Smart Cards or prox cards.
E-card Docking Station	The device in the Printer that accepts Smart Cards with an ISO Smart Card contact Station. This allows the User to write to the Smart Card chip with a standard RS-232 interface in the back of the Printer or with the optional built-in Encoder.

Section 18: Glossary of Terms

Term	Definition
Edge-to-Edge	Refers to the maximum printable area on a card resulting in printed cards with virtually no border.
ECP Mode (Enhanced Capabilities Port Mode)	A type of Parallel Port mode, developed by Microsoft, to increase the port throughput and improve performance.
EE Memory	An abbreviation for EEPROM.
EEPROM (Electrically Erasable Programmable Read Only Memory)	A microchip based non-volatile memory storage device that can be rewritten in the field. The chip can hold new values as the Printer adapts its operational parameters.
Encoder (Smart Card)	An electro-mechanical interface to transfer data from the PC to a chip or Magnetic Stripe built into the card.
Encoder (wheel)	An electromechanical device, attached to a shaft that detects the change in rotational position, incremented to count ticks per revolution. The Printer's Encoder wheel both detects motion and measures the amount of rotation in the movement of the Ribbon.
Engine	A generic term for a collection of systems and mechanisms that is dedicated to executing a specific function. A Printer that also laminates would have both a print engine and a Lamination engine.
EOF (End Of Form)	The trailing edge of the card, detected to indicate when the Printer should stop printing.

Section 18: Glossary of Terms

Term	Definition
EPP (Enhanced Parallel Port)	A type of Parallel Port mode, developed by Intel, to increase the port throughput.
EPROM (Electrically Programmable Read Only Memory)	A microchip based non-volatile memory storage device that cannot be rewritten in the field. Firmware for many Fargo Printers is stored on these chips and so a change of the chip is necessary for an upgrade.
Escape sequence	A string or control character that indicates to the processor that what follows is a command and not data.
ESD (ElectroStatic Discharge)	The discharge of static electricity (high voltage, low current) that can damage electronic devices.
Ethernet	A system of networking a series of computers for the sharing of data or peripherals.
Film	A thin flexible transparent sheet used to carry dye-impregnated material or resin to be transferred to the card.
Firmware	The instruction set, stored in chip memory, inside the Printer that controls functional and operational data. Some models require a chip change for updates; some Firmware can be changed by reprogramming from the PC.
Flash Memory	A microchip based non-volatile memory device that holds its data when power is removed. This allows for field reprogramming of the Printer commands, such as Printer Firmware upgrades, without the necessity of changing chips.
Font	A character set similar in style and form. Fonts can be graphical or mathematical constructs, represented by a series of dots or an Assembly of curves and lines.

Section 18: Glossary of Terms

Term	Definition
FPGA (Field Programmable Gate Array)	A microchip with configurable logic circuits installed that takes care of the very high speed and intensive data manipulations needed by the printing engine.
Full bleed	Printing that covers the entire card surface.
Gamma	The degree of contrast of an image or the display of a monitor determined by the slope of a characteristic curve relating optical density to relative log exposure.
Glossy / Matte	A smooth polished surface in comparison to a rougher matte surface. Matte cards have a surface index (Ra) of approximately 65 microinches while glossy have a Ra = 3.
Glossy PVC	A card made of PVC with a smooth polished surface (Surface roughness of approximately 0 - 10 micro-inches). This is required for direct to card Dye-Sublimation printing.
Graphical Device Interface (GDI)	A Windows standard for protocol between Drivers and applications and the Windows interface. An application uses a Driver to rasterize the data in the format necessary for the Printer but also for the Windows interface to execute the print commands.
Gray Scale	A graduation through the various brightness levels from white to black.
Halftoning	A process in monochrome printing that simulates continuous tone by using changes to the distribution of single dots. Increasing the number of dots in a given area increases the darkness even though the individual dots stay the same size.

Section 18: Glossary of Terms

Term	Definition
Hard Drive	A high capacity storage device in a PC consisting of non-removable magnetically encodable platters.
Hardware	Physical components of a system such as the Printer, the PC, the power supply.
HDP (High Definition Printing™)	The High-Definition Printing process prints full-color images onto clear HDP transfer film (InTM). The HDP film is then fused to the card through heat and pressure via a heated Roller. The Printhead is capable of 256 shades with a sharper print and better color match.
Head	Abbreviation for Printhead.
Heat sink	A device used to dissipate heat into the ambient.
Heat Seal	A resinous film transferred by the Printhead onto the back of an HDP intermediate transfer film to facilitate adhesion.
HiCo (High Coercivity)	The Coercivity value of magnetic media between 2500 - 4000 Oe (ISO 7811-6). Fargo's High Coercivity encodes at 2750 Oe.
HTML (HyperText Markup Language)	A standard protocol used to format text files for use in a browser or on the Internet.
HTTP (HyperText Transfer Protocol)	A standard protocol by which computers can transfer data, compatible through multiple platforms.
IC (Integrated Circuit)	An electronic device that contains many individual circuits interconnected and placed within a discrete package.
ID (Identification)	An abbreviation for identification.

Section 18: Glossary of Terms

Term	Definition
IEEE 1284 (Institute of Electrical and Electronics Engineers 1284)	A standard method of signaling for a bi-directional parallel interface on personal computers. To ensure proper Printer communications and image output, Fargo recommends a parallel interface cable that complies with this specification.
Image	A collection of pictures or graphical elements that compose the visual features on a card. Also refers to the digital representation.
Inhibit (panel)	The Inhibit or I designation under YMCKI indicates the ability to prevent the transfer of film to the card surface. Users can select these Ribbon types to prevent film from transferring over security features, signature panel or other areas of special interest on the card surface.
Input	Any data or material being transferred to the Printer.
Input Hopper	The area of the Printer that stores the blank cards, ready to print.
Intermediate Transfer Media (InTM)	A thin flexible material coated with a resin material into which the dye is transferred from the Ribbon by the Printhead. The film is then transferred to the card surface by the Transfer or Hot Roller.
Invert F-Panel option	<p>This refers to the ability to cause light or white areas of the image to fluoresce and dark colors to remain dark on the printed card when exposed to a UV light. (Note: This was requested because the fluorescent dye color is bright when black light is applied to it. By default, the dark areas of the image will fluoresce on the card and the lighter or white areas will have no dye applied.)</p> <p>The User can select the Invert F-Panel option to cause the black in the design to show as dark on the card. This option is recommended if the user is printing a photo.</p>

Section 18: Glossary of Terms

Term	Definition
ISO	From the Greek, iso, meaning same. Used to represent data from the International Organization for Standardization.
JIS II (Japanese Industrial Standard)	The standard for encoding to a Magnetic Stripe provided by the Japan Standards Association. The single track is as wide as ISO tracks 1 and 2 combined and in the same approximate location as those tracks but on the front of the card. The Coercivity level is 600 Oe.
K Panel	An area of a multicolored Ribbon (e.g., YMCK) that contains black resin for transfer to the card surface. Also used in reference to the application of preference to items printed on the card - those using the black panel in lieu of a process (YMC) black.
Lamination	The application of a film or resinous substance, fused by heat and pressure, to the surface of a card.
LAN (Local Area Network)	An array of several computers connected through a series of data transfer cables for the sharing of data and peripherals.
Landscape	A document layout that is viewed with the document's long axis in a horizontal orientation.
LCD (Liquid Crystal Display)	A device that contains a liquid crystal between two pieces of polarized film through which reflected or ambient light can pass. When a current is applied, the liquid's polarity changes and blocks the passage of the light resulting in an opaque area of the display. The areas are arrayed to form characters.
LED (Light Emitting Diode)	A semiconductor that emits light when a current is applied.
Media	A generic reference to anything onto which the Printer can transfer an image including cards, Ribbon and film.

Section 18: Glossary of Terms

Term	Definition
LoCo (Low Coercivity)	The Coercivity value of magnetic media between 250 - 600 Oe (ISO 7811-2). Fargo's Low Coercivity encodes at 300 Oe.
LPT Port (Line Printer Port)	The system abbreviation for a PC's parallel Printer port.
Mag encoding	The process of orienting successive magnetic bits to produce a serial data string.
Mag stripe	An area of the card with an applied or impregnated ferrous material that can hold encoded data through a series of prescribed polarity changes.
Mag Track	An area of a magnetic strip running the length of the card, with a given width and position, constitutes a track. This is the area dedicated to one data string, restricted to specific rules of format. ISO standards specify three Magnetic Tracks on the back of a card. The JIS standard specifies one track on the front.
Mag Verify	A process to confirm proper magnetic encoding. After encoding, the information is read off back and compared to the intended string.
MB (Megabyte)	A unit of storage that equals 1,048,576 bytes.
Memory	A generic term for any device that stores digital information using magnetic media or digital chip storage device.
Menu	A descriptive list of headings above nested functions that aid navigation to a specific operation. These are found in computer applications, with the heading at the top of a subset of like functions. They are also on the Printer LCD control panel.

Section 18: Glossary of Terms

Term	Definition
Monochrome	An image composed of a single color.
Network	A series of computers connected by data transfer cable for communication and sharing of functions and peripherals.
Oersted (Oe)	The unit of magnetic field strength named after Dutch scientist Hans Christian Oersted who found the science of electromagnetism.
Offset	The prescribed distance between a reference point and the target point. The offset in card printing can refer to the position of the image relative to the leading edge or the distance of the start of magnetic encoding from the leading edge of the card.
O-Ring	A rubber ring used as a belt in several media driving applications.
OS (Operating System)	The instructions installed on the computer hard drive that run the computer's operations and applications. The Driver used for any given OS will differ from other platforms. The correct version Driver must be loaded for the Printer to interface with the OS and the application to print.
Output	Any product of the Printer including card image, encoded data and Lamination.
Output hopper	The portion of the Printer that accepts the completed cards.
Overlay	A resin-like substance that is transferred by the Printhead to the card surface over a printed dye image to prevent image fading, increase abrasion durability and prevent dye migration.
Oversized Cards	Oversized cards are used for more efficient visual identification and are available in many non-standard sizes. The most popular sizes are CR-90 (3.63 x 2.37/92mm x 60mm) and CR-100 (3.88 x 2.63/98.5mm x 67mm).

Section 18: Glossary of Terms

Term	Definition
Overlamine	Protective clear or holographic material to increase security and durability applied over the printed surface with a hot Roller.
Parallel	A method of data transfer in which serial data is divided into sections and sent simultaneously down parallel wires to speed transfer rate.
Parallel Port	A communication socket on a device that allows for parallel data transfer.
PC (Personal Computer)	A stand-alone, programmable, electronic device that can store, retrieve and process data consisting of a CPU, mouse, keyboard and monitor.
PCB (Printed Circuit Board)	A solid, multi-layered plate on which electronic elements are attached, either through the Board or on the surface.
Peel	The removal of a film or Ribbon from a card surface (at a perpendicular angle) to ensure proper transfer, then separation, from the card surface.
Peel-Off	A bar on the Lamination section that holds the film at the correct position and provides proper peel angle.
Peripheral	Any device that is attached externally to a PC. These often share the same data cable or port as a Printer and can be the source of communication problems.
Pinch Roller	A free spinning (non-driven) Roller that presses the card against the drive Roller, on the opposite side, to ensure an adequate normal force for proper traction.

Section 18: Glossary of Terms

Term	Definition
Pixel	Short for picture element. The smallest element of a graphic.
Platen	The hard rubber Roller that drives the media through the Printer, providing support to the backside of the media during printing or laminating.
PET	Abbreviation for polyester terephthalate, often called polyester. Sheets of PET are laminated with sheets of PVC to produce thermal acceptance composite cards.
Port	A communication interface, serial or parallel, used for the transference of data. Includes USB and Ethernet.
PolyGuard Overlaminat	A 1-mil or .6-mil thick polyester material that enhances card security and durability applied over the printed surface with a hot Roller. Available as clear or with embedded holographic-type security images.
Portrait	A document layout that is viewed with the document's long axis in a vertical orientation.
Potentiometer	An electronic resistor with a variable resistance value that can be mechanically set.
Print Driver	A software utility that serves as an interface between the Printer and the Windows GDI (Graphical Device Interface), making the Printer's functions available through the software application. It also provides the format information for the rasterizing of the print file including any necessary escape or function commands.
Print Job	A file of one or more cards for the Printer to print, including image data and Printer functions, transmitted through the parallel interface and at times stored temporarily in the print Buffer and spooler.

Section 18: Glossary of Terms

Term	Definition
Print Server	A device used to connect and control a Printer on a network.
Printhead	The device on a Printer that produces the image on the media.
PVC	Abbreviation for polyvinyl chloride, often called vinyl. PVC is the component of the 0.002 thick clear, dye receptive film on the surface of the identification card and is the primary component of the identification card cores.
Queue	A sequence of files or sets of data, awaiting transmission or processing.
Proximity (Prox) Card	Proximity cards allow access and tracking utilizing contactless technology, usually by communicating through a built-in antenna.
Prox Card Encoder	The prox card Encoder uses an HID ProxPoint® Plus reader mounted on the e-card docking Station inside the Printer/Encoder. The ProxPoint is a read only device producing a Wiegand signal that is converted to RS-232 using a Cypress Computer Systems CVT-2232. Application programs can read information from HID prox cards via a RS-232 signal through a dedicated DB-9 port on the outside of the Printer labeled Prox.
RAM (Random Access Memory)	A storage device for digital information to be held temporarily, to facilitate processing.
Rasterize	The process of converting the elements of a graphic into a bitmap to be printed.
Reboot	Cycling the power to the Printer so that it resets and reinitializes.

Section 18: Glossary of Terms

Term	Definition
Registration	The quality of the alignment of the separate primary-color images: YMCK.
Resin	A semi-solid material.
Resolution	The number of individual pixels in a graphic, taken over a given length, used to indicate the sharpness of the picture and the level of detail. The number of elements in the Printhead determines Fargo Printer resolution.
RFI (Radio Frequency Interference)	Electromagnetic waves radiated by poorly shielded cables or electronic devices that interfere with the operation or data transfer of another device.
RFID (Radio Frequency Identification)	This is a way of transmitting information via radio frequency. Data is sent from an RFID transceiver to an RFID tag (that is embedded in a Resin Ribbon).
RGB (Red/Green/Blue)	The three primary colors of the luminance or additive, model. Combinations of these three colors can produce practically all the colors of the spectrum that humans can detect. Computer monitors operate on an RGB model.
Ribbon	The dye impregnated film that is used for color printing.
Ribbon cable	Parallel wires held flat in a row by plastic insulation.
RibbonTraq	A method of placing bar code-like marks on the transition area between color panels. These marks are arranged for detection by a reflective Sensor array for the identification of Ribbon type and the Ribbon position.

Section 18: Glossary of Terms

Term	Definition
RMA number (Return Merchandise Authorization number)	A number, acquired from HIDGlobal Support, which authorizes the return of merchandise for repair or credit.
Roller	Elements of the Printer used for the transport of media consisting of a rotating steel shaft (for Ribbon) or a rotating steel shaft with a rubber cylinder installed at the shaft midpoint (for moving cards).
RS-232	An interface standard, established in 1969 by the Electronic Industries Association, regarding the connecting of computer peripherals.
Saturation	A measure of the degree of color, from gray, with the same brightness.
Self-test	A pre-determined print file used to confirm Printer operation typically sent from the Driver or stored in the Printer's memory.
Sensor	An electro-mechanical/electro-optical device used to indicate a change in state in the Printer such as when a card reaches a certain location.
Serial communications	The transfer of data, one bit at a time and in sequential order, using a single wire.
Serial interface	A sub D 9 pin input/output port on the Printer, used for serial communication with the PC for AS400 operating systems or for e card encoding.

Section 18: Glossary of Terms

Term	Definition
SIMM (Single In-Line Memory Module)	An array of memory chips, attached to a printed circuit Board that installs in a slot on the main Board.
Simplex	Single-sided printing.
Smart Card	Smart cards have an embedded computer circuit that contains either a memory chip or a microprocessor chip. There are several types of Smart Cards: Memory, Contact, Contactless, Hybrid (Twin), Combi (Dual Interface), Proximity and Vicinity.
Software	Instructions saved in computer memory that directs the computer to perform certain tasks and functions.
Spooler	A computer application that allows the spooling of print jobs.
Spooling	Rather than moving a print job directly to the Printer, the job is written to the disk so that the User can access the application faster while Windows takes care of printing in the background.
SS (Start Sentinel)	The character denoting the end of a magnetic data string.
Stacker	The device that moves the finished cards onto the output column ordering them First In, First Out.
Stepper Motor	A Motor whose shaft turns in discrete steps, rather than continuously.
String	A sequence of characters that form a line of data.
Surface mount	A method of mounting circuit elements onto the surface of a circuit Board, attached at solder pads, rather than through holes in the Board.

Section 18: Glossary of Terms

Term	Definition
Surge Protector	An electronic device, placed in serial to the Printer's power supply, that prevents damage to the Printer from electronic surges and electrical current that is outside of the normal parameters.
Switch Box	An electromechanical device to which a User can connect several peripheral devices to the Parallel Port simultaneously, yet using the selector switch to designate the active port.
TAC	Thermal Acceptance Composite cards. Card stock produced by laminating sheets of PVC with sheets of PET for better thermal distortion resistance. Ultra III cards.
Temp file	A temporary file, generated automatically by Windows, to store the information for an active document. Windows should delete these files when the application is closed.
Test Print	A file stored in or generated through windows that is sent to the Printer to test basic functionality.
Thermistor	An electronic resistor on the Printhead with a resistance value that varies in proportion to the heat to which it is exposed.
Thermocouple	A device for measuring temperature using a junction of two wires of dissimilar metals that produce a voltage when heated that varies proportionally with the temperature.
Thin Film Overlamine	A 0.25-mil thick resin material that enhances card security and durability applied over the printed surface with a hot Roller. Available as clear or with embedded holographic-type security images.

Section 18: Glossary of Terms

Term	Definition
Through-hole	A method of mounting circuit elements with the leads passing through holes in the circuit Board and soldered on the opposite side.
Timeout	An interruption of a print job that occurs when a function is not completed in the time allotted by the operating system.
TOF (Top of Form)	The leading edge of the card, as it travels through the Printer.
Track	The area on a mag stripe designated to contain the magnetic data string.
Troubleshooting	The process of investigating and determining the cause of a problem.
TrueType (TT)	A font format that produces each character using a mathematical equation, rather than a graphical representation, resulting in a much sharper, cleaner image.
UltraCard	The FARGO brand of card stock recommended for use in FARGO Printers, with the necessary glossy surface and composed of PVC.
UltraCard III	The FARGO brand of card stock, recommended for use in FARGO Printers that laminate, with the necessary glossy surface and composed of PVC and PET to prevent heat distortion.
Update	The process of installing a new revision of software or Firmware to implement new changes to the Printer's command codes and procedures.
UPS (Un-interruptible Power Supply)	An AC power supply, typically powered by batteries, which provides temporary power to the PC or Printer during an interruption of the supply voltage.

Section 18: Glossary of Terms

Term	Definition
USB (Universal Serial Bus)	A 1.5M/sec (12Mbit/sec) serial communication interface that can support 127 separate devices consisting of 4 wires: power, ground, data in and data out.
Virtual Memory	A technique used by Windows when chip memory is exhausted, in which data is written to the hard to hold data temporarily and support Window's operations.
Wrinkle	The appearance in the card image of wavy or arched lines, either colored or clear, caused by improper film or Ribbon tension.
YMC	The designation of colored Ribbon by the panels of color in the order in which they are printed: Yellow (Y), Magenta (M) and Cyan (C).
YMCK	The designation of colored Ribbon by the panels of color in the order in which they are printed: Yellow (Y), Magenta (M), Cyan (C) and Black (K).
YMCKH	The designation of colored Ribbon by the panels of color in the order in which they are printed: Yellow (Y), Magenta (M), Cyan (C), Black (K) and Heat Seal (H).
YMCKI	The designation of colored Ribbon by the panels of color in the order in which they are printed: Yellow (Y), Magenta (M), Cyan (C), Black (K) and Inhibit (I).
YMCKK	The designation of colored Ribbon by the panels of color in the order in which they are printed: Yellow (Y), Magenta (M), Cyan (C), Black (K), Black (K) (the second K is for backside, black only printing).

Section 18: Glossary of Terms

Term	Definition
YMCKO	The designation of colored Ribbon by the panels of color in the order in which they are printed: Yellow (Y), Magenta (M), Cyan (C), Black (K) and Overlay (O).
YMCKOK	The designation of colored Ribbon by the panels of color in the order in which they are printed: Yellow (Y), Magenta (M), Cyan (C), Black (K), Overlay (O), Black (K) (used for backside, black only printing).
YMCFK	The designation of colored Ribbon by the panels of color in the order in which they are printed: Yellow (Y), Magenta (M), Cyan (C), Fluorescing and Black (K).